

KAPTURE™

FULL BODY HARNESS

USER INSTRUCTION MANUAL

FULL BODY HARNESS

THESE INSTRUCTIONS APPLY TO THE FOLLOWING MODELS:

UFH90131G, UFH90131GQ, UFH90141G, UFH90141GQ,
UFH90251G, UFH90251GQ, UFH90341G, UFH90341GQ,
UFH90471G, UFH90471GQ, UFZ910001, UFZ910005,
UFZ920001, UFZ920011



This manufacturer's user instruction manual meets the requirements of ANSI Z359.11-2021. As per OSHA, this manual should be used as a part of an employee training program.

▲ WARNING

The products enumerated in this instruction manual are a part of a personal protective, work support or rescue system. It is important that the user reads and follows the manufacturer's instructions for each component of the system. This manual contains information which is important to the user's safety and should be kept in a safe place for future reference as needed. The instructions provided in this manual are meant for the use of this equipment and should be read thoroughly and understood by the user before the equipment is used. Manufacturer's instructions must be properly followed for the correct use and maintenance of this equipment. Please contact KStrong for any questions regarding use of this equipment.

Fall arrest systems and equipment are life saving products and are designed to reduce the potential of serious injury in the event of a fall. However, it is important to note that the user may experience an impact of force on their body in the event of a fall. The victim of a fall may also experience adverse effects due to prolonged suspension in a Full Body Harness (FBH). In case there is a doubt about the user's ability to utilize this product, the user must consult a physician. Pregnant women and minors are not considered fit for the use of this equipment.

TRAINING

In order to ensure that the user is familiar with the instructions provided in this manual, it becomes the responsibility of the user to undergo proper training on the proper inspection, use and maintenance of this equipment. It is also the employer's responsibility to ensure that all users are trained in proper use, inspection and maintenance of Fall Protection Equipment.

TECHNICAL SPECIFICATIONS

S.No	Harness Model	Harness Series	Construction of Webbing	Hardware	Minimum Breaking Strength	Conformity
1	UFH90131G	Derrickman Harness Kapture™ Element	Polyester	Steel	5000 lbs.	OSHA 1926.502 and 1910.66 ANSI Z359.11-2021
2	UFH90131GQ					
3	UFH90141G		Polyester	Steel	5000 lbs.	OSHA 1926.502 and 1910.66 ANSI Z359.11-2021
4	UFH90141GQ					
5	UFH90251G		Polyester	Steel	5000 lbs.	OSHA 1926.502 and 1910.66 ANSI Z359.11-2021
6	UFH90251GQ					
7	UFH90341G		Polyester	Steel	5000 lbs.	OSHA 1926.502 and 1910.66 ANSI Z359.11-2021
8	UFH90341GQ					
9	UFH90471G		Polyester	Steel	5000 lbs.	OSHA 1926.502 and 1910.66 ANSI Z359.11-2021
10	UFH90471GQ					
11	UFZ910001	Derrickman Belly belt Kapture™ Element	Polyester	Steel	5000 lbs.	OSHA 1926.502 and 1910.66
12	UFZ910005	Derrickman Belly belt Kapture™ Element	Polyester	Steel	5000 lbs.	OSHA 1926.502 and 1910.66
13	UFZ920001	Derrickman Bosun seat Kapture™ Element	Polyester	Steel	5000 lbs.	OSHA 1926.502 and 1910.66
14	UFZ920011	Derrickman Bosun seat Kapture™ Element	Polyester	Steel	5000 lbs.	OSHA 1926.502 and 1910.66

IMPORTANT INFORMATION

- It is important to inspect the equipment according to the manufacturer's instructions before each use.
- Inspection of equipment should be done on a regular basis by a qualified person and the results recorded in the inspection log. DO NOT REMOVE product labels which include important warnings and information for the "Authorized Person".
- "Authorized Person" is a person who is exposed to fall hazards during the course of their work. This individual requires formal training in the use of personal fall protection equipment and systems. The term "Authorized Person" may be used interchangeably with "User" and "End-User".
- DO NOT ALTER the equipment in any way.
- Always send the equipment back to the manufacturer, or to the persons or entities authorized in writing by the manufacturer, for any repairs if required.
- Never use any natural material like manila, cotton, etc. as part of the Fall Protection System.
- Fall protection equipment should only be used for the purpose for which it has been designed.
- This equipment should never be used for towing and hoisting or for any other purpose than its intended use.
- A competent person must ensure compatibility of the system to minimize any potential for accidental disengagement.
- Authorized persons or users shall be trained on all warnings and instructions provided in this manual.
- It is important for all authorized persons and users to refer to the applicable ANSI Standards and to the regulations governing occupational safety.
- Take proper precautions to remove any debris, material, obstructions, etc., from the work area which could cause injury, or otherwise interfere with the functioning of the system.
- KStrong Anchors should be used only with the combinations of components, sub-systems or both which may affect or interfere with the safe function of one another. Be certain that connecting devices are compatible and that other elements of the PFAS are safe and compatible before use.
- Always check for obstructions below the work area to make sure that the potential fall path is clear.
- Keep the equipment away from anything that could damage it such as sharp edges, rough or abrasive surfaces, high temperature surfaces, heat and welding sources, moving machinery, electrical hazards, etc.
- It is important to keep in mind environmental hazards when selecting fall protection equipment.
- Do not expose the equipment to chemicals, highly corrosive or caustic environments, or to direct sunlight and UV radiation, which may cause UV degradation.
- Such harmful environments require a more frequent inspection and servicing program of the fall protection equipment to maintain the integrity and safety of the equipment. Contact KStrong if in doubt.
- All the synthetic material of fall protection equipment must be protected from slag, hot sparks, open flames or other heat sources.
- It is recommended that heat resistant materials are used in such applications. It is important to allow adequate fall clearance below the work surface.
- Always have a Rescue Plan ready and at hand when using this equipment.

▲ WARNING

- **Immediately discard any product which is exhibiting unusual wear, deformity or deterioration.**
- **Immediately remove from service any equipment that has been subjected to a fall.**

COMPONENT COMPATIBILITY

Component compatibility with KStrong manufactured fall protection equipment is ensured by strictly following the instructions for each type of equipment used. However, if the user utilizes combinations of components or sub systems that are manufactured by others, only a "qualified" or "competent" person (as defined in OSHA) can ensure the compatibility. If substitutions or replacements are made with non-approved components or sub systems, then this may severely affect the compatibility of the equipment, making the complete system unsafe for use.

COMPATIBILITY OF CONNECTORS

To ensure the compatibility of the connectors with their connecting element, it is important to safeguard that the sizes and shapes of the connectors and the connecting elements do not allow their gate mechanisms to open inadvertently, notwithstanding their orientation with each other. All hooks, carabiners, D-rings and other such connectors must be capable of supporting a min. force of 5000 lbs. (23 kN). All connectors must be compatible with all system components like anchorages, etc. Never use equipment which is not compatible as this may cause the connectors to disengage unintentionally. All connectors must be compatible in shape and size. As per ANSI Z359.12 and OSHA, only self-locking snap hooks and carabiners may be used.

CONNECTIONS USING CONNECTORS

Ensure that only self-locking snap hooks and carabiners are used with this equipment. All connections should be compatible in size, shape and strength. The connectors used should be suitable to each application. Ensure that they are fully closed and locked while in use. NEVER USE INAPPROPRIATE CONNECTIONS

While using KStrong snap hooks and carabiners, they should not be connected as below:

- Two or more connectors should never be attached to a single D-ring.
- Never attach a connector that could result in a load on its gate.
- Connectors should not be connected in a false engagement. It should be visually confirmed that the connector is fully engaged to the anchor point. Avoid conditions that allow for features that protrude from the connectors to catch on the anchor, giving a false sense of being connected.
- Connectors should not be connected to each other.
- Connectors should not be connected directly to the webbing or to the rope lanyard or tie back, unless specifically allowed by the manufacturer.
- Connectors should not be connected to any object which does not allow the connector gate to close or lock. Anchor shapes that allow roll out to occur should never be used for connection. If the anchor, to which the snap hook or carabiner is attached, is under sized or irregular in shape, then this may allow for the gate of the connector to come in contact with the anchor, thereby causing the connector to open up and possibly disengage from the anchor. This is known as roll out of the connector.

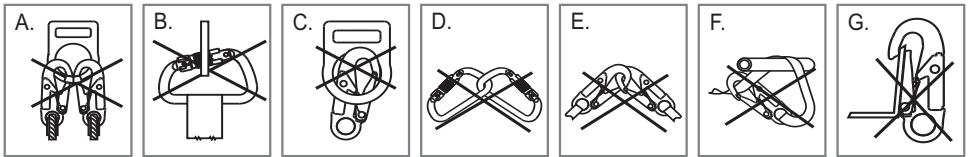

- Do not use connectors on an anchorage object as shown in figure A to G.

⚠ WARNING

Large throat opening snap hooks should not be connected to standard size D-rings or similar objects. The reason for this is if the hook or D-ring twists or rotates, then this may result in a load on the gate of the connector. Large throat snap hooks are specifically designed for use on fixed structure elements such as rebar or cross members. These are shaped in such a way that they cannot capture the gate of the hook.

IMPORTANT RESTRICTIONS WHILE MAKING CONNECTIONS:

- A snap hook should not be connected into a loop or thimble of a wire rope, or attached to it in any way that may slack the wire rope.
- Do not make connections where the connector locking mechanism can come into contact with a structural member, or other such equipment, as it may potentially unlock the connector and release the connection.
- To connect to a single or a pair of soft loops on a harness, a carabiner that can fully close and lock should only be used. Snap hooks are not allowed for such connections.
- A carabiner may be connected to a loop or ring connector that is already occupied by a choker style connector. Snap hooks are not allowed for such connections.

If the connecting element to which a snap hook (shown) or carabiner attaches is undersized or irregular in shape, a situation could occur where the connecting element applies a force to the gate of the snap hook or carabiner. This force may cause the gate (of either a self-locking or a non-locking snap hook) to open, allowing the snap hook or carabiner to disengage from the connecting point.

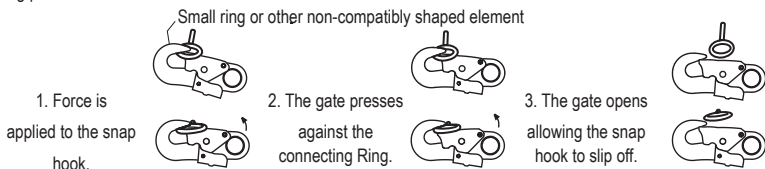

CONNECTING SUBSYSTEMS

Use only those connecting subsystems (self-retracting lifeline, lanyard, rope grab and lifeline, cable sleeves) that are suitable for your application. See subsystems manufacturer's instructions for more information. Some harness models have web loop connecting points. Do not use snap hooks to connect to the web loop. Use a self-locking Karabiner to connect to a web loop. Ensure that the Karabiner is connected in such a way that it close not lead to cross-gate load. Sometimes lanyards may be sewn directly to the web loop forming a permanent connection. Do not make multiple connections onto one web loop.

RESCUE PLAN

A rescue plan should be well documented and in place before performing work at height. The rescue operation must be performed by trained and competent personnel only. The rescue expert team should supervise the rescue operation performed. It is also advised to work in pairs while working on site.

ENVIRONMENTAL HAZARDS

It is important to take additional precautions while using this equipment in the presence of any environmental hazards so as to prevent injury to the user or damage to the equipment.

Environmental hazards may include the following, but are not limited to:

- Chemicals
- Extreme Temperatures
- Corrosive Environments
- Gases
- High Voltage Power Lines
- Sharp Edges
- Moving Machinery and Vehicles

Please contact KStrong for use of this equipment in the presence of any environmental hazard.

WARNING

This equipment is not designed to be used in high temperature environment. It is important to protect this equipment when using near activities like welding or metal cutting. Hot sparks may cause damage to this equipment or burn it. Contact KStrong with any questions regarding the details on use of this equipment in high temperature environment.

ANCHORAGE STRENGTH

The application type determines the anchorage strength requirement. As per ANSI Z359.1 the necessary anchorage strength for the following applications is listed below:

- **Fall Arrest:** As per OSHA 1926.500 and 1910.66: anchorages that are used for attachment of Personal Fall Arrest Systems (PFAS) shall be independent of any anchorage being used to support or suspend platforms. They should be capable of withstanding a minimum load of 5000 lbs. (23 kN) per user attached, or should be designed, installed and used as part of a complete PFAS which maintains a safety factor of at least two. Rating of the anchorage should always be done under the supervision of a qualified person.
- **Work Positioning:** The structure to which the work positioning system (WPS) is attached must be able to sustain a static load of min. 3000 lbs. (13.3 kN), applied in the directions permitted by the work positioning system. Or, it should be able to sustain two times the potential impact load, whichever is greater; see 1926.502. However, if more than one work positioning system is attached to an anchorage, then the strength mentioned above must be multiplied by the number of WPS attached to the anchorage.
- **Restraint:** The strength requirement of anchorages which are selected for restraint and travel restraint systems is min. of 1000 lbs. (4.5 kN) static load applied in the directions permitted by the system. If more than one restraint and travel restraint system is attached to anchorage, then the 1000 lbs. shall be multiplied by the number of systems attached to the anchorage to determine the min. strength requirement.
- **Rescue:** The minimum strength of the anchorage selected for rescue should be such that it is capable of sustaining a static load of min. 3000 lbs. (13.3 kN) applied in the direction permitted by the system. To determine the strength requirement of the anchorage if more than one rescue system is attached, then multiply 3000 lbs. (13.3 kN) by the number of the systems attached to the anchorage.

GENERAL LIMITATIONS OF FALL ARREST SYSTEM AND REQUIREMENTS

It is important to consider the below mentioned limitations before using or installing this equipment:-

- The **capacity** of the KStrong full body harness is up to 310 lbs. (140 kg) hence, the combined weight (clothes, tools, shoes etc.) of a person using these harnesses should not be more than 310 lbs. It is important to ensure that all the components in the system are rated to a capacity which is appropriate to the application. **(Capacity as per ANSI 130-310 lbs. & as per OSHA 420 lbs.)**

- Free Fall:** As per ANSI Z359.11 the personal fall arrest systems used with this equipment must be rigged in such a way that the free fall does not exceed 6 ft. (1.8 m). Restraint systems must be rigged in such a way that no vertical free fall is possible. Work positioning systems are required to be rigged in a way that the free fall does not exceed 2 ft. (0.6 m). Personal riding systems must be rigged so that there is no vertical free fall possible. Climbing systems must be rigged so that free fall is less than 18 inches (46 cm). Rescue systems must be rigged in such a way that there is no vertical free fall. Contact KStrong for any further information needed.

A	Connecting Subsystem (Energy Absorbing Lanyard Shown)
B	Working Level
C	Lower Level or Obstruction
D	Free Fall - 6 ft. (1.8 m) Max. (per ANSI Z359.11)
E	Deceleration Distance
F	Total Fall Distance Free Fall (D) + Deceleration (E)

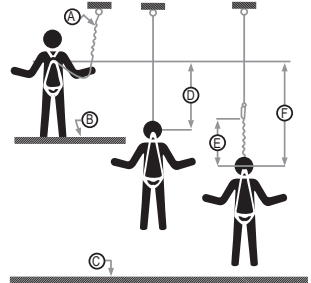

- Fall Clearance:** There should be sufficient clearance below the user to allow the system to arrest a fall so as to prevent the user from striking the ground or any other obstruction. The clearance required depends upon the following factors:

- Harness Stretch - $H_s = H_f - H_i$ (Harness stretch should be \leq (less than equal to) 18 inches)
- Anchorage location
- Type of connecting subsystem used (energy absorbing lanyard, self retracting lifeline (SRL), etc.)

If the only available anchorage is situated below the attachment on the harness; and if there is a risk of fall, then it is essential to use a lanyard with a properly rated energy absorber. It is important to ensure that there is sufficient fall clearance below the user, before using a shock absorbing lanyard. If the weight of the wearer is 220 lbs. and the fall factor is two, we can calculate the fall clearance (which will be equal to the stopping distance $H(2L + 5.74 \text{ ft.})$ + an additional distance of 3.28 ft).

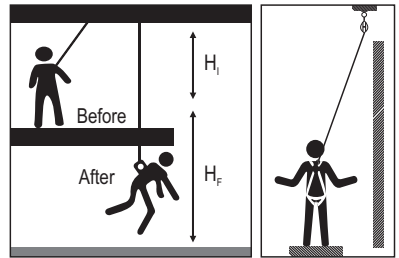

Calculating Total Fall Distances:

Total Fall Clearance below worker is calculated from Anchorage Connection. Free Fall Distance + Energy Absorber Deceleration Distance + Worker height + Safety Factor. Care must be taken to ensure that the total fall distance is clear of obstructions; such as equipment, to avoid contact with a lower level.

Free Fall Distance + Energy Absorber Deceleration Distance + Worker height + Safety Factor = 19 ft. (5.8 m)

Free Fall Distance + Energy Absorber Deceleration Distance + Worker height + Safety Factor = 20 ft. (6.1 m)

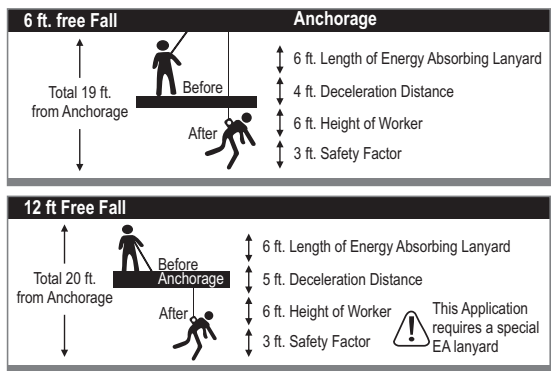

- **Swing Falls:** Swing fall occurs when the position of the anchorage point is not directly above the point where a fall occurs. In such a case if a fall were to occur, it will result in pendulum swing of the fall victim and may also cause them to strike nearby objects with a force. This may cause serious injury or even death. Such swing falls may be minimized by ensuring that the anchorage is directly overhead, and by working as close to the anchorage point as possible. Swing falls will substantially increase the fall clearance required when a SRL or other variable length connecting subsystem is used.
- **Extended Suspension:** Using a full body harness: A FBH is not intended for use in extended suspension applications. If the user is going to be suspended for an extended length of time, it is recommended that some form of a seat support be used. KStrong recommends a seat board, suspension work seat, seat sling, or a boatswain chair. Contact KStrong for more information on these items.
- **Periodic Examination:** Always keep the instructions provided with the product. Take the information from the markings on the product and enter this information in the identification sheet. To ensure the safety of the user, it is essential to check the condition of the equipment through periodic examinations of the product. This equipment must be examined by a qualified person at least once in six months, strictly complying with the manufacturers instructions. Also, record the previous check on the attached sheet. If the equipment is in heavy usage or is used in a harsh environment, then the frequency of inspection should be increased in accordance with regulations. Also check that the markings on the product are legible.

PRODUCT ILLUSTRATION

UFZ920011

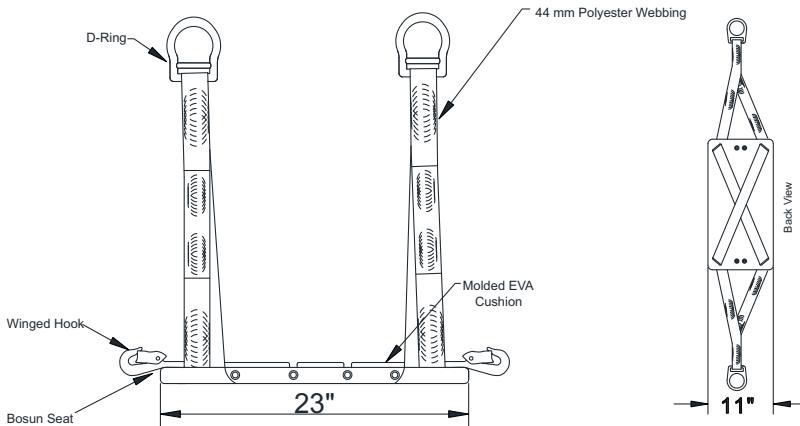

UFZ910001

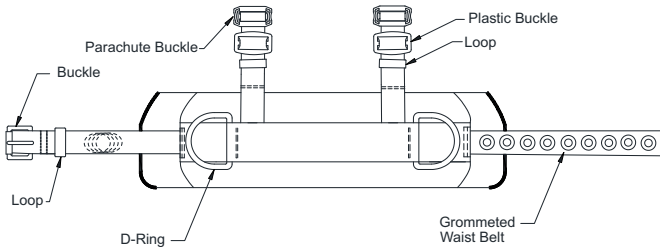

UFH90471G

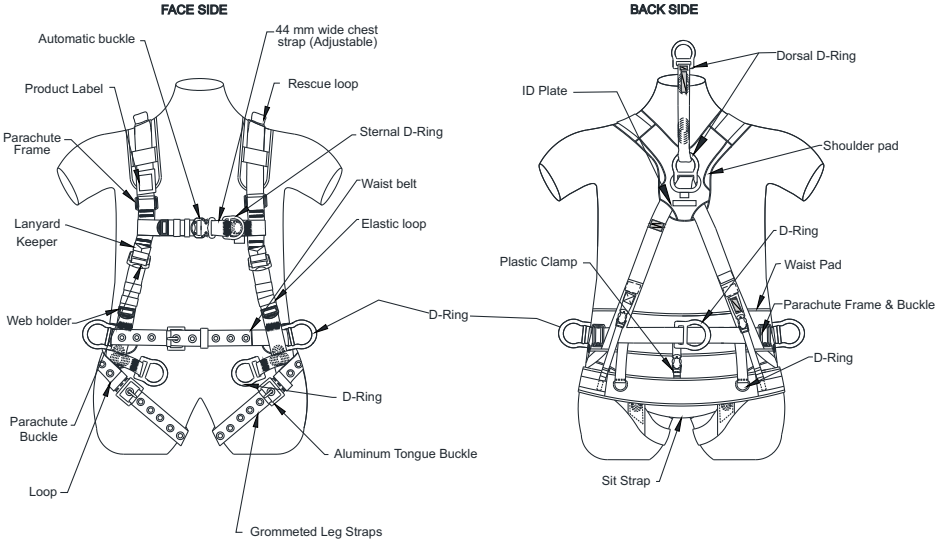

UFH90471G

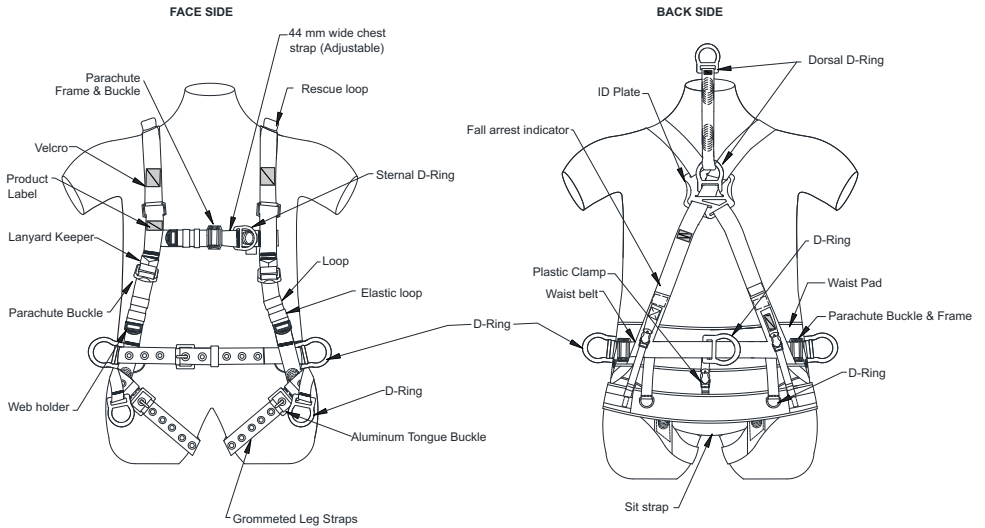

PURPOSE

KStrong full body harnesses are to be used as components in personal fall arrest, restraint, work positioning and rescue systems. The full body harnesses included in this manual conform to ANSI Z359.11-2021, OSHA and CSA Z259.10 Full body harnesses made of Aramid webbing should be used when working with tools, material and environments of high temperature (e.g. foundries, welding, fire services, steel fabrication, oil industry, etc.).

APPLICATION

- **Personal Fall Arrest:** KStrong full body harnesses along with a connecting sub system (e.g. energy absorbing lanyard) typically constitutes a PFAS. The maximum arresting force should not be more than 1800 lbs. (8 kN). Only the dorsal D-ring of the full body harness, D-ring or the attachment element on the back of the full body harness, should be connected to the fall arrest subsystem for fall arrest.
- **Work Positioning:** The full body harness is used to support the user at a work position hence being used as a component of a work positioning system. The full body harness together with a work positioning lanyard constitutes a work positioning system. Personal fall arrest system is always used as back up. For work positioning at height, connect the work positioning sub system (e.g. lanyard) to the belt mounted work positioning attachment anchorage elements (also known as lateral D-rings), or to hip level side D-rings. These D-rings should never be used as connection points for fall arrest.
- **Restraint:** The full body harness constitutes a component of a restraint system, which prevents the user from reaching a fall hazard (e.g. edge of a platform or roof). A full body harness together with a restraint lanyard or restraint line constitutes a restraint system.
- **Controlled Descent:** For applications of controlled descent, a full body harness is connected to a descender or an evacuation system. Such harnesses are equipped with a single sternal level D-ring, one or two frontal D-rings, or a pair of connectors originating below the waist.
- **Rescue:** Configuration of rescue systems is dependent upon the type of rescue. Harnesses that are equipped with D-rings on the shoulders may be used for entry and egress into confined spaces. Hence, the FBH forms a part of the rescue system.
- **Ladder Climbing:** A climbing system prevents the user from falling when climbing a ladder or other climbing structure. A FBH equipped with frontal D-ring on the sternal location is used as a component of the climbing system. Other components of a climbing system includes a vertical cable or rail attached to the structure and a climbing sleeve.

LIMITATION OF USE OF FULL BODY HARNESS

KStrong full body harnesses are to be used as part of personal fall arrest, restraint , rescue or work positioning system.

Full body harnesses are designed in such a way that they work in sync with other elements of a personal fall arrest system. While they are designed to arrest a fall from height, they also minimize the impact load on the wearer. KStrong recommends that only those components or sub systems of the PFAS manufactured by KStrong are used in combination. If other manufacturer's equipment is used, then this should be ensured for compatibility by a qualified person only. If substitutions or replacements are made with non-approved components of sub systems, then this may severely affect the compatibility of the equipment, making the complete system unsafe for use.

HARNESSES FOR THE FOLLOWING TEMPERATURE ENVIRONMENTS

There is a limitation to the use of harnesses with Aramid webbing which are designed for use in high temperature environments. It is important to note the following limitations:

- At exposures from 800°F to 900°F, Aramid webbing begins to char.
- Aramid webbing can withstand limited contact exposure to temperatures up to 1000°F.
- Polyester webbing starts to lose its strength between 300°F to 400°F.
- The melting point of PVC coating on metal hardware is 350°F.

INSPECTION OF FULL BODY HARNESS

It is mandatory to have a detailed visual inspection of all harnesses, lanyards, connectors, etc. prior to each use. This ensures that the equipment is in good condition and is operating correctly. If there are any doubts regarding the safe state of the product, or if the product has been used to arrest a fall, then immediately withdraw the equipment and send it back to the manufacturer or the qualified authorized repair center. Check on the back shoulder straps of the harness for the fall indicator; which should be intact. If a fall indicator is found to be deployed, then the harness should be removed from use immediately. Never attempt to repair or modify personal protective equipment (PPE).

FORMAL INSPECTION

It is mandatory that a competent person other than the user must perform a formal inspection of the PFAS and its components once at least every six months. This frequency should be altered on the basis of conditions for use or exposure. The inspection results should be recorded in the inspection and maintenance log at the end of this manual.

PRE-INSPECTION CHECK OF THE HARNESS

The harness should be inspected prior to each use as per the following guidelines:

- Step 1:** Locate the impact indicators. The stitched impact indicator is the section of the webbing that is folded back into itself and held in place with a specific stitch pattern. This stitch opens up releasing the warning sign on the unfolded webbing when the harness is subjected to a fall. If an impact indicator is found to have been released, then the harness should be immediately removed from service.
- Step 2:** Check the stitches on the harness. They should be intact, not cut or opened.
- Step 3:** Check the webbing by holding it with your hands 6 to 8 inches apart and bending the webbing in an inverted U. By doing it this way, any damaged fibers or cuts can be easily detected. Repeat this process for the entire length of the webbing, checking both sides of each strap. Look out for any frayed edges, broken fibers, cuts, burns, pulled stitches and chemical damage.
- Step 4:** Check the D-rings for sharp edges, distortion, cracks, breaks, and rough edges. Look out for any broken stitching of the D-ring attachments. Also, ensure the D-ring pivots freely.
- Step 5:** Inspect the pads for any cracks, excessive wear and other signs of damage.
- Step 6:** Check the buckle attachments for any unusual wear, frayed or cut fibers, or broken stitching.
- Step 7:** Check the tongue buckles and grommets. The buckle tongues should not be distorted in shape and motion. They should overlap the buckle frames and freely move in their sockets. Also, the roller should turn freely on the frame. Look out for any distortion or sharp edges. The grommets should not be loose, distorted or broken. Also, there should not be any additional punched holes in the webbing.
- Step 8:** Friction buckles should be inspected for distortion. The center and outer bars of the buckle should be straight. Carefully inspect the corners and attachment points at the center bar.
- Step 9:** The quick connect buckle should inspected for distortion, cracks and breaks. The buckles should engage properly and function smoothly.

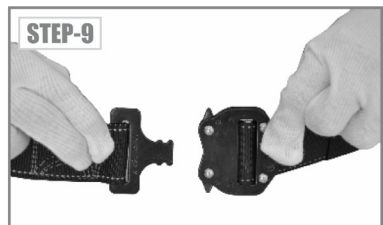
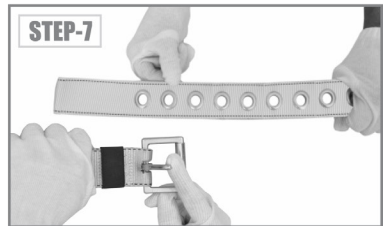
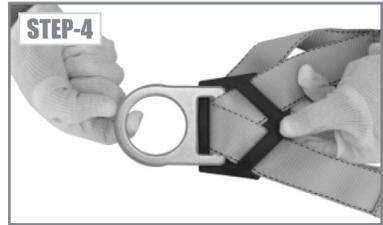
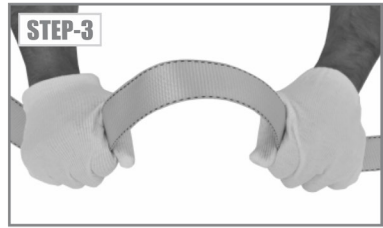

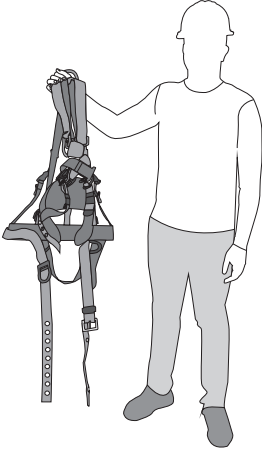
HOW TO WEAR A HARNESS

To don, hold the harness by the back D-Ring ensuring that the straps are not twisted.

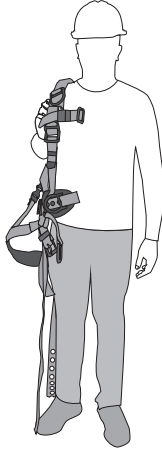

Insert your arms into the shoulder strap making sure that the dorsal D-ring is located on your back and that all the straps don't tangle. While donning ensure that both shoulder straps are sitting flat on top of your shoulders.

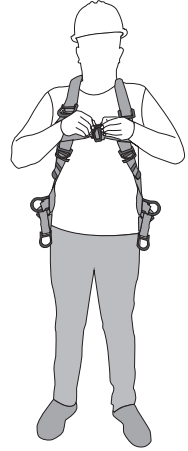

Afterwards for proper fit, buckle and adjust the chest strap ensuring that the chest strap sit approximately 6 inches (15 cm) below the top of your shoulders. Once the buckles are connected and the strap is positioned properly and snug to the chest, tuck the excess webbing into the strap keeper.

Now to center the chest strap, adjust the shoulder straps by pulling on the torso adjustment buckles located on each side of the harness. Then Adjust the shoulder straps equally.

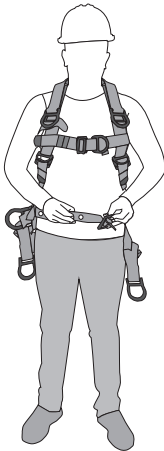

Adjust and buckle the waist belt to get a comfortable, firm fit of the harness.

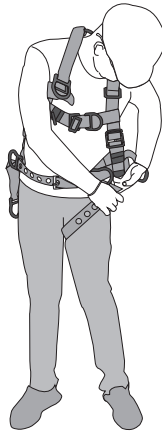

To tighten the leg straps, grasp one of the straps and connect it in front of your harness. The connection will be a tongue buckle with grommet for which slide the strap through the buckle to the grommet to provide a secure, snug fit. Afterwards tuck the remaining strap under the strap keeper and make the connection snug, so as to have ample space under each leg strap to slide at least three fingers through.

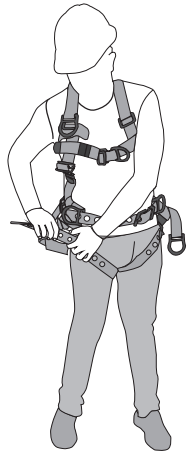

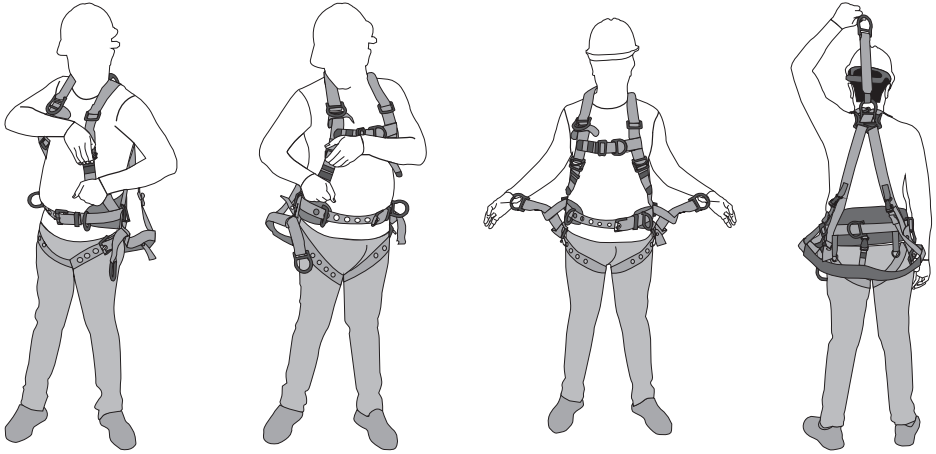

To check & adjust all the straps of the harness to your body adjustment, please check the all the attached points, they should be free to use. While in use, it is important to regularly check fastening and adjustment elements of the harness.

HOW TO USE MONKEY BOARD BELT

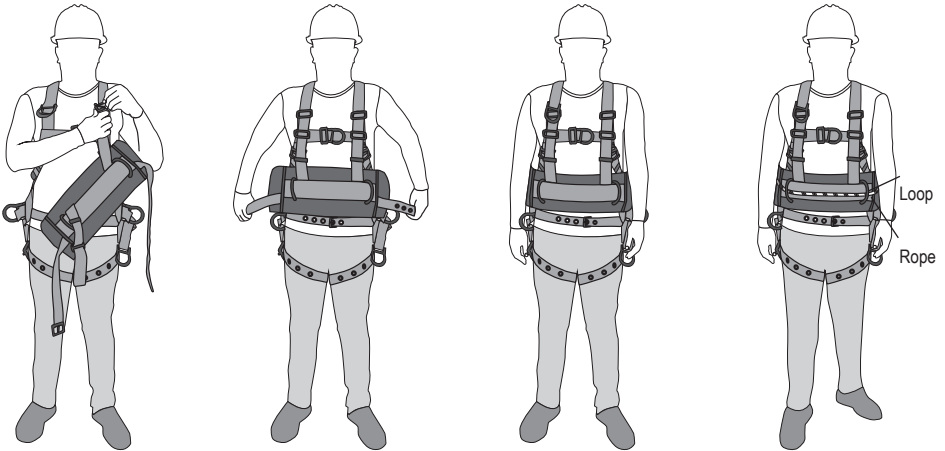

Hold the monkey board by front strap and close both of its buckles placed on the shoulder strap of the harness.

Wrap around the waist belt of the monkey board and close the grommet

Make sure there are no twists in the webbing as this can affect security and comfort.

Not the monkey pad ready to for use.

During use always keep checking for the buckles or adjusting devices for strong fitting.

Lanyard Keeper: When not in use, unused lanyard legs that are still attached to a full body harness D-ring should not be attached to a work positioning element or any other structural element on the full body harness unless deemed acceptable by the competent person. This is especially important when using some types of “Y” style lanyards, as some load may be transmitted to the user through the unused lanyard leg if it is not able to release from the harness. KStrong harnesses come with Lanyard Keepers located at the sternal area, specially meant for parking the unused leg of the lanyard. These also reduce tripping and entanglement hazards.

Web Keepers: KStrong harnesses are provided with web keepers that serve to control the loose ends of the straps. These loose ends of straps, if left uncontrolled, can get caught in machinery or cause accidental disengagement of an adjuster. Hence, the user must ensure that there are no loose ends of the straps, and that these are kept in place by the web keepers.

PROPER FIT OF THE HARNESS

It is of extreme importance that the hWarness fits snugly and is properly adjusted on the wearer. Loosely fitted harnesses can result in serious injury or even death. It is extremely important that all straps of the harnesses are properly connected so as to ensure fall safety. Make the following checks after wearing a harness:

- Check the chest strap:** It should be in the middle of your chest in front of the sternum, 6 to 8 inches below the trachea. If the chest strap is positioned too high, then this may cause strangulation when the strap moves upwards in the event of a fall. Conversely, if the chest strap is positioned too low or is not connected at all, then the wearer could risk slipping out of the harness in the event of a fall.
- Check the leg straps:** They should be properly adjusted for complete safety. It is extremely important to wear the leg straps as they hold the wearer within the harness in the event of a fall preventing serious injury or death. Leg straps should be snug but not over tight where they obstruct normal blood circulation in the legs.
- Check the sub pelvic strap:** Which not only provides support to the body in the event of a fall, but also gives support when used for positioning. This strap comfortably provides a 'seat' for the buttocks, when in a seated position. In the event of a fall, the wearer should simply lift up his legs to transfer weight to the sub pelvic strap.



⚠ WARNING

After donning the harness, fasten and adjust all the parachute buckles properly before performing any work. If the buckles are not fastened and adjusted properly, then this may result in serious injury or death in the event of a fall from height. Consult a qualified/competent person or contact KStrong in case of questions regarding proper fit of the harness.

USAGE OF ATTACHMENT POINT ON THE HARNESS (ANSI Z359.11-2021):

- Dorsal Attachment:** Always use the dorsal attachment element as the primary fall arrest attachment, unless the application allows the use of an alternate attachment. You may also use the dorsal attachment for travel restraint or rescue. While the victim is supported by the dorsal attachment in the event of a fall, the design of the FBH is such that it directs the load starting from the shoulder straps to around the thighs while still supporting the user. After a fall has occurred, the victim supported by the dorsal attachment lies in an upright body position with a minor lean to the front and very little pressure to the lower chest. The sliding dorsal attachments, as opposed to fixed dorsal D-rings, are easier to adjust to different user sizes allowing for a better vertical rest position at the time of a fall, but it can increase the stretch of the full body harness.
- Sternal Attachment:** You may use the sternal attachment as an alternative fall arrest attachment in applications where the dorsal attachment is found to be inappropriate by a competent person, and where there is no chance to fall other than feet first. Sternal attachment can be used for ladder climbing in various situations including ladder climbing with an overhead self-retracting lifeline for fall arrest, rope access, ladder climbing with a guided type fall arrester and work positioning. The sternal attachment may also be used for travel restraint or rescue. While the victim is supported by the sternal attachment, during a fall, the design of the full body harness is such that it directs the load starting from the shoulder straps to around the thighs while still supporting the user. When the sternal attachment point is used for fall arrest, the user assumes a roughly sitting or cradled body position after a fall, with their weight concentrated mostly on thighs, buttocks and lower back.

During work positioning while the user is supported by the sternal attachment, this will result in

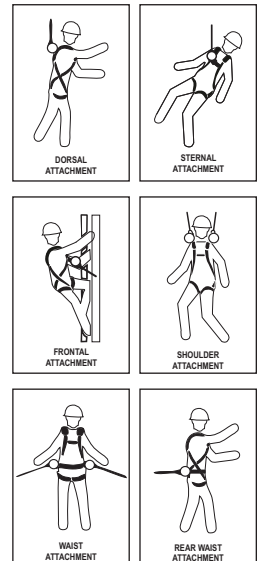

a more or less upright body position. While using the sternal attachment for fall arrest, measures should be taken by a competent person evaluating the application to ensure a fall occurs only feet first. It is also important to limit the allowable free fall distance.

It is important to note and take care that where the sternal attachment point is present on an adjustable chest strap, then in the event of a fall or during extraction or suspension, this strap may accidentally move up towards the throat of the wearer, causing them to choke.

Hence, for these applications, a competent person must always consider full body harness models with a fixed sternal attachment.

- **Frontal Attachment:** Where there is no chance to fall in a direction other than feet first, the frontal attachment may be used as a connection for ladder climbing, for guided type fall arresters and also for work positioning. After a fall has occurred or during work positioning, the victim supported by the frontal attachment will result in a sitting body position, with the upper body in an upright position concentrating the weight on the buttocks and thighs. When supported by the frontal attachment, the design of the full body harness is such that it directs the load directly around the thighs and under the buttocks by means of the sub-pelvic strap. While using the frontal attachment for fall arrest, measures should be taken by a competent person evaluating the application to ensure a fall occurs only feet first. It is also important to limit the allowable free fall distance.
- **Shoulder Attachment Elements:** Always use the shoulder attachment elements as a pair. They are an acceptable attachment for rescue and entry/retrieval. Never use shoulder attachment elements for fall arrest.
- **Recommendation:** The shoulder attachment elements should always be used in conjunction with a yoke which comes with a spreader element keeping the FBH shoulder straps separated properly.
- **Waist, Rear Attachment:** The waist, rear attachment is only meant to be used solely for travel restraint. The waist, rear attachment element is NOT to be used for fall arrest. The waist, rear attachment shall never be used to support the entire body weight of the user and shall strictly be subjected to minimal loading through the waist.
- **Hip Attachment Elements:** The hip attachment elements shall be used solely for work positioning and shall always be used as a pair. The hip attachment elements are NOT meant for fall arrest. These hip attachments are often used for utility workers climbing poles, construction workers tying rebar and using the same to climb on form walls, and also used by arborists for work positioning. Users are cautioned not to store the unused end of a fall arrest lanyard on the hip attachment elements to avoid any tripping hazards. Excessive loading could be caused to the full body harness and the user through the unused portion of the Multiple Leg Lanyard.
- **Suspension Seat:** Always use the suspension seat attachment elements as a pair, and solely for work positioning. The suspension seat attachment elements are not meant for fall arrest. Suspension seat attachments are designed to be used for work involving suspension at height for longer durations, allowing the user to comfortably sit on the suspension seat. The best examples for the use of a suspension seat are window cleaning of large buildings, painting of facades, etc.

ADDITIONAL INFORMATION FOR FULL BODY HARNESS

- **Training:** It is essential that the users of this type of equipment receive proper training and instruction, including detailed procedures for the safe use of such equipment in their work application. ANSI/ASSE Z359.2, Minimum Requirements for a Comprehensive Managed Fall Protection Program, establishes guidelines and requirements for an employer's managed fall protection program. These include policies, duties and training, fall protection procedures, eliminating and controlling fall hazards, rescue procedures, incident investigations, and evaluating program effectiveness.

- **Correct Fit:** Correct fit of a full body harness is essential to proper performance. Users must be trained to select the proper size and maintain the fit of their full body harness.

Users must follow manufacturer's instructions for proper fit and sizing, paying particular attention to ensure that buckles are connected and aligned correctly, leg straps and shoulder straps are kept snug at all times, chest straps are located in the middle chest area and leg straps are positioned and snug to avoid contact with the genitalia should a fall occur.

KStrong full body harnesses meet ANSI/ASSE Z359.11 and are intended to be used with other components of a PFAS that limit maximum arrest forces to 1800 lbs. (8 kN) or less.

- **Suspension Intolerance:** Suspension intolerance also known as suspension trauma or orthostatic intolerance, is a serious condition that can be controlled with prompt rescue and post fall suspension relief devices. A conscious able user may deploy a suspension relief device allowing the user to remove tension from around the legs, freeing blood flow, which can delay the onset of suspension intolerance. An attachment element extender is not intended to be attached directly to an anchorage or anchorage connector for fall arrest. An energy absorber must be used to limit maximum arrest forces to 1800 lbs.(8 kN). The length of an attachment element extender may affect free fall distances and free fall clearance calculations.
- **Full Body Harness Stretch:** The amount the FBH component of a personal fall arrest system can stretch and deform during a fall can contribute to the overall elongation of the system in stopping a fall. It is important to include the increase in fall distance created by FBH Stretch, as well as the FBH connector length, the settling of the user's body in the FBH and all other contributing factors when calculating total clearance required for a particular fall arrest system.
- Due to the nature of soft loop connections, it is recommended that soft loop attachments only be used to connect with other soft loops or

carabiners. Snap hooks should not be used unless approved for the application by the manufacturer.

MAINTENANCE, SERVICE AND STORAGE

- A full body harness can be cleaned with water and a mild soap solution. However, if a harness is excessively dirty, or there is a build-up of material like paint, etc., then this may hamper the harness from functioning properly. In severe cases the webbing may be degraded to a point where it weakens. In such a case remove the harness from service.
- Never use bleach or bleach solutions to clean the harness as this may damage the webbing. Always dry the harness by hanging to air dry. Do not force dry with heat. The hardware should be wiped off with a clean dry cloth. Contact KStrong for any further query.
- Additional maintenance and servicing procedures must be completed by an authorized service center only.
- Store full body harnesses in a cool dry clean environment away from direct sunlight. Avoid areas where there may be the presence of chemical vapors. It is extremely important to thoroughly inspect the FBH after extended storage.

ANNEX A – NORMATIVE

Note: The following information from the ANSI/ASSP Z359.11 standard is required to be included in the instruction manual for the end user. The manufacturer of this equipment may impose more stringent restrictions on the use of the products they manufacture; see the manufacturer's instructions.

1. It is essential that the users of this type of equipment receive proper training and instruction including detailed procedures for the safe use of such equipment in their work application. ANSI/ASSP Z359.2, Minimum Requirements for a Comprehensive Managed Fall Protection Program, establishes guidelines and requirements for an employer's managed fall protection program including policies, duties and training; fall protection procedures; eliminating and controlling fall hazards; rescue procedures; incident investigations; and evaluating program effectiveness.
2. Correct fit of a full body harness (FBH) is essential to proper performance. Users must be trained to select the size and maintain the fit of their FBH.
3. Users must follow manufacturer's instructions for proper fit and sizing, paying particular attention to ensure that buckles are connected and aligned correctly, leg straps and shoulder straps are kept snug at all times, chest straps are located in the middle chest area and leg straps are positioned and snug to avoid contact with the genitalia should a fall occur.
4. FBHs which meet ANSI/ASSP Z359.11 are intended to be used with other components of a personal fall arrest system that limit maximum arrest forces to 1800 pounds (8kN) or less.
5. Suspension intolerance, also called suspension trauma or orthostatic intolerance, is a serious condition that can be controlled with good harness design, prompt rescue and post fall suspension relief devices. A conscious user may deploy a suspension relief device allowing the user to remove tension from around the legs, freeing blood flow, which can delay the onset of suspension intolerance. An attachment element extender is not intended to be attached directly to an anchorage or anchorage connector for fall arrest. An energy absorber must be used to limit maximum arrest forces to 1800 pounds (8kN). The length of the attachment element extender may affect free fall distances and free fall clearance calculations.
6. FBH stretch, the amount the FBH component of a personal fall arrest system will stretch and deform during a fall, can contribute to the overall elongation of the system in stopping a fall. It is important to include the increase in fall distance created by FBH stretch, as well as the FBH connector length, the settling of the user's body in the FBH and all other contributing factors when calculating total clearance required for a particular fall arrest system.
7. When not in use, unused lanyard legs that are still attached to a FBH D-ring should not be attached to a work positioning element or any other structural element on the FBH unless deemed acceptable by the competent person and manufacturer of the lanyard. This is especially important when using some types of "Y" style lanyards, as some load may be transmitted to the user through the unused lanyard leg if it is not able to release from the harness. The lanyard parking attachment is generally located in the sternal area to help reduce tripping and entanglement hazards.
8. Loose ends of straps can get caught in machinery or cause accidental disengagement of an adjuster. All FBH shall include keepers or other components which serve to control the loose ends of straps.
9. Due to the nature of soft loop connections, it is recommended that soft loop attachments only be used to connect with other soft loops or carabiners. Snaphooks should not be used unless approved for the application by the manufacturer.
Sections 10-16 provide additional information concerning the location and use of various attachments that may be provided on this FBH.
10. **Dorsal** – The dorsal attachment element shall be used as the primary fall arrest attachment unless the application allows the use of an alternate attachment. The dorsal attachment may also be used for travel restraint or rescue. When supported by the dorsal attachment during a fall, the design of the FBH shall direct load through the shoulder straps supporting the user and around the thighs. Supporting the user, post fall, by the dorsal attachment will result in an upright body position with a slight lean to the front with some slight pressure to the lower chest. Considerations should be made when choosing a sliding versus fixed dorsal attachment element. Sliding dorsal attachments are generally easier to adjust to different user sizes, and allow a more vertical rest position post fall, but can increase FBH stretch.

11. **Sternal** – The sternal attachment may be used as an alternative fall arrest attachment in applications where the dorsal attachment is determined to be inappropriate by a competent person and where there is no chance to fall in a direction other than feet first. Accepted practical uses for a sternal attachment include, but are not limited to, ladder climbing with a guided type fall arrester, ladder climbing with an overhead self-retracting lifeline for fall arrest, work positioning and rope access. The sternal attachment may also be used for travel restraint or rescue.

When supported by the sternal attachment during a fall, the design of the FBH shall direct load through the shoulder straps supporting the user and around the thighs. Supporting the user, post fall, by the sternal attachment will result in roughly a sitting or cradled body position with weight concentrated on the thighs, buttocks and lower back. Supporting the user during work positioning by this sternal attachment will result in an approximate upright body position.

If the sternal attachment is used for fall arrest, the competent person evaluating the application should take measures to ensure that a fall can only occur feet first. This may include limiting the allowable free fall distance. It may be possible for a sternal attachment incorporated into an adjustable style chest strap to cause the chest strap to slide up and possibly choke the user during a fall, extraction, suspension, etc. The competent person should consider FBH models with a fixed sternal attachment for these applications.

12. **Frontal** – The frontal attachment serves as a ladder climbing connection for guided type fall arresters where there is no chance to fall in a direction other than feet first or may be used for work positioning. Supporting the user, post fall or during work positioning, by the frontal attachment will result in a sitting body position with the upper torso upright with weight concentrated on the thighs and buttocks. When supported by the frontal attachment the design of the FBH shall direct load directly around the thighs and under the buttocks by means of the sub-pelvic strap. If the frontal attachment is used for fall arrest, the competent person evaluating the application should take measures to ensure that a fall can only occur feet first. This may include limiting the allowable free fall distance.
13. **Shoulder** – The shoulder attachment elements shall be used as a pair and are an acceptable attachment for rescue and entry/retrieval. The shoulder attachment elements shall not be used for fall arrest. It is recommended that the shoulder attachment elements be used in conjunction with a yoke which incorporates a spreader element to keep the FBH shoulder straps separate.
15. **Hip** – The hip attachment elements shall be used as a pair, and shall be used solely for work positioning. The hip attachment elements shall not be used for fall arrest. Hip attachments are often used for work positioning by arborists, utility workers climbing poles and construction workers tying rebar and climbing on form walls. Users are cautioned against using the hip attachment elements (or any other rigid point on the Full Body Harness) to store the unused end of a fall arrest lanyard, as this may cause a tripping hazard, or, in the case multiple leg lanyards, could cause adverse loading to the Full Body Harness and the wearer through the unused portion of the lanyard.
16. **Suspension Seat** – The suspension seat attachment elements shall be used as a pair, and shall be used solely for work positioning. The suspension seat attachment elements shall not be used for fall arrest. Suspension seat attachments are often used for prolonged work activities where the user is suspended, allowing the user to sit on the suspension seat formed between two attachment elements. An example of this use would be window washers on large buildings.
14. **Waist, Rear** – The waist, rear attachment shall be used solely for travel restraint. The waist, rear attachment element shall not be used for fall arrest. Under no circumstances is it acceptable to use the waist, rear attachment for purposes other than travel restraint. The waist, rear attachment shall only be subjected to minimal loading through the waist of the user and shall never be used to support the full weight of the user.
15. **Hip** – The hip attachment elements shall be used as a pair and shall be used solely for work positioning. The hip attachment elements shall not be used for fall arrest. Hip attachments are often used for work positioning by arborists, utility workers climbing poles and construction workers tying rebar and climbing on form walls. Users are cautioned against using the hip attachment elements (or any other rigid point on the FBH) to store the unused end of a fall arrest lanyard as this may cause a tripping hazard or, in the case of multiple leg lanyards, could cause adverse loading to the FBH and the wearer through the unused portion of the lanyard.
16. **Suspension Seat** – The suspension seat attachment elements shall be used as a pair and shall be used solely for work positioning. The suspension seat attachment elements shall not be used for fall arrest. Suspension seat attachments are often used for prolonged work activities where the user is suspended allowing the user to sit on the suspension seat formed between the two attachment elements. An example of this use would be window washers on large buildings.

NOTE

Do not attempt to disassemble the unit or make repairs to the equipment. Send the equipment back to the manufacturer, or persons or entities authorized in writing by the manufacturer to make repairs to the equipment.

Lifespan: The estimated product Lifespan is 10 years from the date of first use. The following factors can reduce the Lifespan of the product: intense use, contact with chemical substances, especially aggressive environments, extreme temperature exposure, UV exposure, abrasions, cuts, violent impacts, bad use or maintenance.

Disclaimer: Prior to use, the end user, must read and understand the manufacturer's instructions supplied with this product at the time of shipment and seek training from their employer's trained personnel on the proper usage of the product. Manufacturer is not liable or responsible for any loss, damage or injury caused or incurred by any person on grounds of improper usage or installation of this product.

LABEL

ANSI Z359.11-2021
ANSI Z359 recognizes the use of this
harness only within a capacity range of:
130-310 lbs.

K-STRONG®
UNPROVED SAFETY
I:CAPTURE® EQUIPMENT
LVA-11 FULL BODY HARNESS

QR CODE

K-STRONG®
UNPROVED SAFETY
I:CAPTURE® EQUIPMENT
LVA-11 FULL BODY HARNESS

Barcode

Model : UFH90471G
Material : Polyester & Steel
DOM : MM/YYYY
UID : XXXXXXXXXX

⚠ WARNING
The product should be IMMEDIATELY removed from service if subjected to a fall or if harness has failed inspection.

SM ML LXL XXL

K-STRONG®
UNPROVED SAFETY
I:CAPTURE® EQUIPMENT
LVA-11 FULL BODY HARNESS

HARNESS APPLICATION
The Full Body Harness contains following attachment points.

Dorsal Waist
Sternal Frontal

K-STRONG®
UNPROVED SAFETY
I:CAPTURE® EQUIPMENT
LVA-11 FULL BODY HARNESS

Complies with:
ANSI Z359.11-2021, A10.32-2012 &
OSHA 1926.502 and 1910.66 Requirements

Capacity Range:
ANSI-130-310 lbs. OSHA- 130-420 lbs.

Ensure only compatible connectors are made. Before using, inspect for rips, tears, frays or any possible damage which may weaken the product's overall strength in case of a fall. Keep safe from sharp edges and abrasive surfaces.

⚠ WARNING
Ensure manufacturer's instructions provided at the time of shipment are followed at all times for proper use, maintenance and inspection.

FAILURE TO DO SO COULD RESULT IN SERIOUS INJURY OR DEATH. ANY ALTERATION, ABUSE OR MISUSE OF THIS PRODUCT VOIDS THE WARRANTY.

Made in India kstrong.com

K-STRONG®
UNPROVED SAFETY
I:CAPTURE® EQUIPMENT
LVA-11 FULL BODY HARNESS

INSPECTION GRID
Ensure product is inspected thoroughly before every use. Inspection must be done by a competent person and recorded every six months. If equipment fails inspection IMMEDIATELY REMOVE FROM SERVICE.

Date of First Use:
Product lifetime is indefinite as long as equipment passes pre-use and Competent Person Inspections.

YR	Mo	Da	Mo	Da	Mo	Da	Mo	Da	Mo	Da
MO										
1										
2										
3										
4										
5										
6										
7										
8										
9										
10										
11										
12										

DO NOT REMOVE LABELS.
DO NOT USE IF TAGS ARE MISSING.

K-STRONG®
UNPROVED SAFETY
I:CAPTURE® EQUIPMENT
LVA-11 BELLY BELT

QR CODE

K-STRONG®
UNPROVED SAFETY
I:CAPTURE® EQUIPMENT
LVA-11 BELLY BELT

(TO BE USED WITH FULL BODY HARNESS ONLY)

Barcode

Model : UFZ910005
Material : Polyester & Steel
DOM : MM/YYYY
UID : XXXXXXXXXX

⚠ WARNING
The product should be IMMEDIATELY removed from service if subjected to a fall or if harness has failed inspection.

K-STRONG®
UNPROVED SAFETY
I:CAPTURE® EQUIPMENT
LVA-11 BELLY BELT

Complies with:
OSHA 1926.502 and 1910.66 Requirements.

Capacity Range:
ANSI-130-310 lbs. OSHA- 130-420 lbs.

Ensure only compatible connectors are made. Before using, inspect for rips, tears, frays or any possible damage which may weaken the product's overall strength in case of a fall. Keep safe from sharp edges and abrasive surfaces.

⚠ WARNING
Ensure manufacturer's instructions provided at the time of shipment are followed at all times for proper use, maintenance and inspection.

FAILURE TO DO SO COULD RESULT IN SERIOUS INJURY OR DEATH. ANY ALTERATION, ABUSE OR MISUSE OF THIS PRODUCT VOIDS THE WARRANTY.

Made in India kstrong.com

K-STRONG®
UNPROVED SAFETY
I:CAPTURE® EQUIPMENT
LVA-11 BELLY BELT

INSPECTION GRID
Ensure product is inspected thoroughly before every use. Inspection must be done by a competent person and recorded every six months. If equipment fails inspection IMMEDIATELY REMOVE FROM SERVICE.

Date of First Use:
Product lifetime is indefinite as long as equipment passes pre-use and Competent Person Inspections.

YR	Mo	Da	Mo	Da	Mo	Da	Mo	Da	Mo	Da
MO										
1										
2										
3										
4										
5										
6										
7										
8										
9										
10										
11										
12										

DO NOT REMOVE LABELS.
DO NOT USE IF TAGS ARE MISSING.



KStrong Inc.
150 N. Radnor Chester Road Suite F200
Radnor, Pennsylvania 19087 United States
Phone/Fax: 1-833-KSTRONG

www.kstrong.com

USA

South America

Asia

AKSJUFH90471G/070723/V2