

KSTRONG®

UNRIVALED SAFETY.

2024 Q4 - CATALOG



WELCOME TO UNRIVALED SAFETY

With the support of over 4000 employees worldwide and nearly 43 acres of manufacturing production under roof, KStrong is well positioned to help your company protect its most valuable assets, its employees. In addition to meeting all OSHA fall protection codes in the USA, KStrong prides itself in providing your company with Level 3 ANSI certified products, the highest level of certification available.



As one of the world's largest Full-Service providers of fall protection, we can help your company tackle and solve even the most difficult fall hazards, those where traditional fall protection solutions come up short. KStrong Services Group (KSG) offers Engineering, Training and Consulting services to help your company comply with all OSHA fall hazard requirements.

We look forward in 2024 and beyond to keeping your employees working at elevation and in confined spaces safer!

Sincerely,

A handwritten signature in black ink that reads "John H. Kemp, Jr." in a cursive style.

John Kemp
President KStrong USA/Canada

TABLE OF CONTENTS

1. Self-Retracting Devices (SRD)	4
Micron™ Series	4
Micron™ Arc Flash Series	6
BRUTE™ Series	8
Cable	8
BRUTE-AL™ Aluminum	9
Web	10
BRUTE™ LE Leading Edge	12
BRUTE-AL™ Aluminum LE Leading Edge	13
Backer™ LE Leading Edge	14
Backer™ LE Leading Edge Web	16
Sealed Block	18
2. Body Wear - Full Body Harness Kapture™ Series	20
Essential	20
Elite	22
Epic	27
Element	27
Arc Flash	28
Welding Flame Retardant	30
Oil & Gas Derrick	31
Harness Accessories	32
Harness Feature Chart	34
Harness Sizing Chart	37
3. Shock Absorbing Lanyards (SAL)	38
Internal Design	38
Elasticated Design	39
Clear Pack Design	40
Specialty	41
LE Rated	42
Arc Flash	43
4. Work Positioning Lanyards (WPL)	44
5. Fall Protection Kits	45
6. Anchorages	46
7. Roofer Kits, Anchors, Grabs & Vertical Lifelines (VLL)	49
8. Horizontal Lifelines (HLL)	52
9. Confined Space/Rescue Retrieval	56
10. EVAC-R+ Rescue System	62
11. Connectors	63
12. Tool Lanyard Drop Prevention	64
13. Ladder Climbing System	68
14. Bags	70
15. Quick Index	71
16. Compass™ Mobile Asset Management	72

SELF-RETRACTING LIFELINES

KStrong is proud to offer a full range of ANSI rated Class 1 and Class 2 self-retracting devices to help workers meet nearly every user requirement covering a wide variety of applications. KStrong's Micron™ and BRUTE™ brands have become the preferred choice in construction, utilities maintenance, and general industries as they provide durable performance and reliability, supported with industry-preferred Level 3 ANSI independent 3rd-party testing documentation. KStrong continues to expand its self-retracting device offering to the market in 2024 with the introduction of Arc-Flash rated Micron™ units and additional lifeline lengths within the BRUTE™ product brand.

MICRON™ SRL SERIES

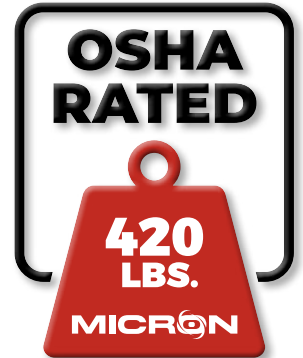

Micron™ SRL Series | Personal



Class
1
Anchor at or
above dorsal D-ring

Class
1
Anchor at or
above dorsal D-ring

Class
1
Anchor at or
above dorsal D-ring

Class
1
Anchor at or
above dorsal D-ring

Class
1
Anchor at or
above dorsal D-ring



SELF-RETRACTING LIFELINES



Class 1
Anchor at or above dorsal D-ring



Class 1
Anchor at or above dorsal D-ring



Class 1
Anchor at or above dorsal D-ring



Class 1
Anchor at or above dorsal D-ring



Class 1
Anchor at or above dorsal D-ring

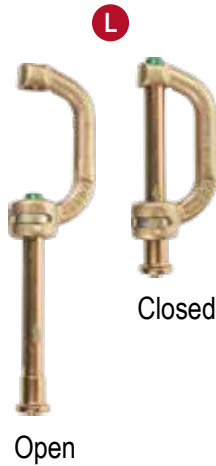

L

Closed

Open

Model	Length	Description	Class
A	UFS350002	6 ft. Steel Snap Hook; comes with locking carabiner UFC401101	1
B	UFS350002D	6 ft. Twin Model - Steel Snap Hook; comes with UFC409151	1
C	UFS351102	6 ft. Aluminum Carabiner; comes with locking carabiner UFC401101	1
D	UFS351102D	6 ft. Twin Model - Aluminum Carabiner; comes with UFC409151	1
E	UFS354002	6 ft. Steel Rebar Hook; comes with locking carabiner UFC401101	1
F	UFS354002D	6 ft. Twin Model - Steel Rebar Hook; comes with UFC409151	1
G	UFS356002	6 ft. Aluminum Rebar Hook w/ Steel ANSI Gate; comes with locking carabiner UFC401101	1
H	UFS356002D	6 ft. Twin Model - Aluminum Rebar Hook w/ Steel ANSI Gate; comes with UFC409151	1
J	UFS359002	9 ft. Tie-back Hook; comes with locking carabiner UFC401101	1
K	UFS359002D	9 ft. Twin Model - Tie-back Hook; comes with UFC409151	1
L	UFC409151	Twin/Single Connector (Steel Pin)	

MICRON™ SRL SERIES



ASTM F887-20

Micron™ Arc Flash SRL Series | Personal



UFC401101
Carabiner included
with every Micron™
single SRL.

**OSHA
RATED**

**420
LBS.**

MICRON

SELF-RETRACTING LIFELINES



Class
1
Anchor at or
above dorsal D-ring

Class
1
Anchor at or
above dorsal D-ring

Class
1
Anchor at or
above dorsal D-ring

G



	Model	Length	Description	Class
A	UFS390006	6 ft.	Arc Flash Rated, Steel Snap Hook; comes with locking carabiner UFC401101	1
B	UFS390006D	6 ft.	Arc Flash Rated Twin Model - Steel Snap Hook; comes with UFC409151	1
C	UFS394006	6 ft.	Arc Flash Rated, Steel Rebar Hook; comes with locking carabiner UFC401101	1
D	UFS394006D	6 ft.	Arc Flash Rated Twin Model - Steel Rebar Hook; comes with UFC409151	1
E	UFS396006	6 ft.	Arc Flash Rated, Aluminum Rebar Hook w/ Steel ANSI Gate; comes with locking carabiner UFC401101	1
F	UFS396006D	6 ft.	Arc Flash Rated Twin Model - Aluminum Rebar Hook w/ Steel ANSI Gate; comes with UFC409151	1
G	UFC409151		Twin/Single Connector (Steel Pin)	

SELF-RETRACTING LIFELINES

BRUTE™ SRL Series - Wire Cable | Overhead

Model	Length	Cable Type	Attachment End	Installation Carabiner	Class
A UFS330008	8 ft.	Stainless Steel	Snap Hook	UFC401101	1
B UFS310010	10 ft.	Galvanized Steel	Snap Hook	UFC401101	1
C UFS310018(SS)	18 ft.	Stainless Steel	Snap Hook	UFC401101	1
C UFS310020	20 ft.	Galvanized Steel	Snap Hook	UFC401101	1
D UFS310025(SS)	25 ft.	Stainless Steel	Snap Hook	UFC401101	1
D UFS310030	30 ft.	Galvanized Steel	Snap Hook	UFC401101	1
D UFS310030(SS)	30 ft.	Stainless Steel	Snap Hook	UFC401101	1
E UFS310050	50 ft.	Galvanized Steel	Snap Hook	UFC401101	1
E UFS310050(SS)	50 ft.	Stainless Steel	Snap Hook	UFC401101	1
F UFS310090	90 ft.	Galvanized Steel	Snap Hook	UFC401101	1

BRUTE™
SRL SERIES - WIRE CABLE

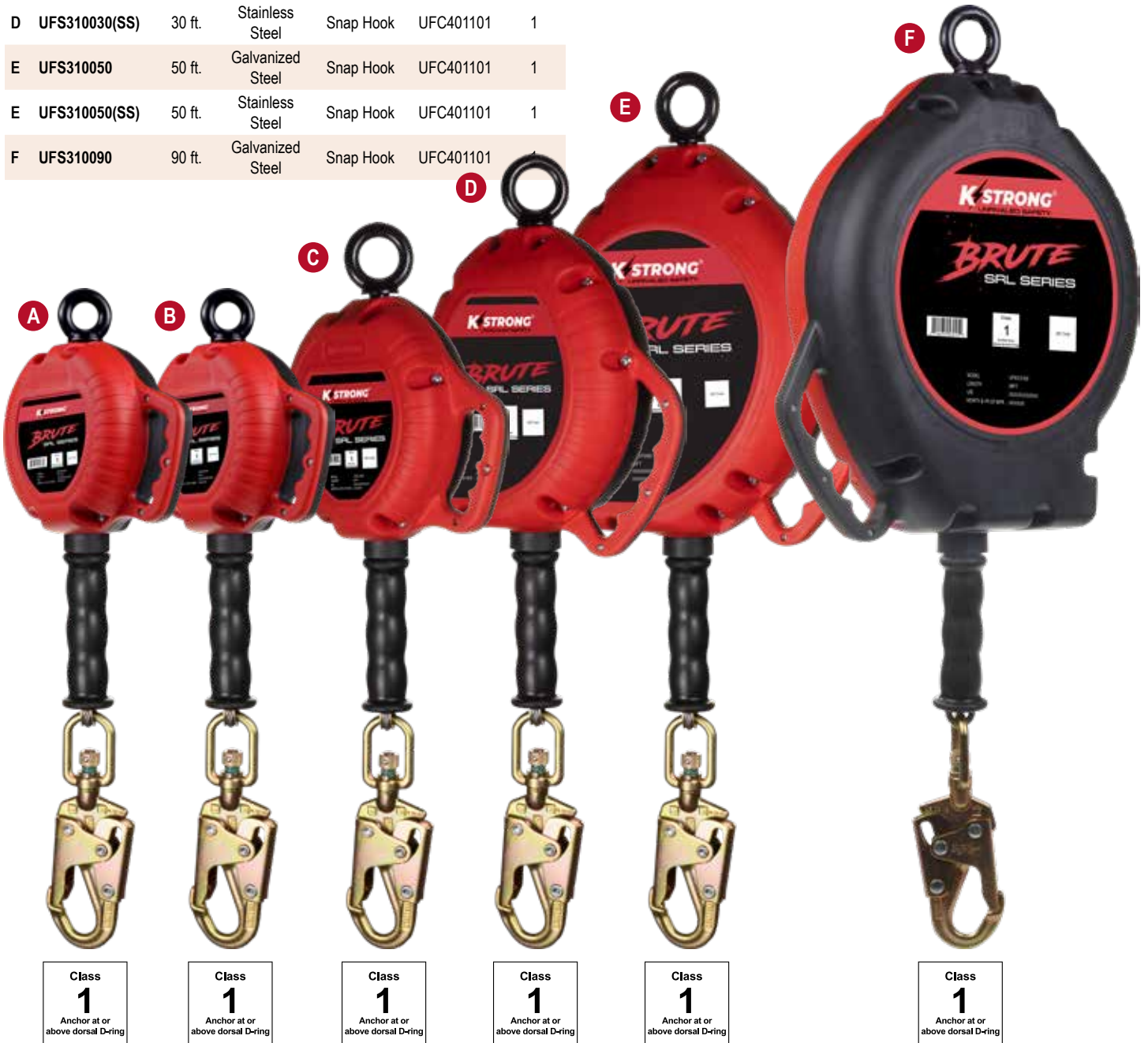

SELF-RETRACTING LIFELINES

BRUTE™ & BRUTE-AL™ SRL Series - Wire Cable | Overhead

Model	Length	Cable Type	Case	Attachment End	Installation Carabiner	Tag Line	Class
G UFS310130	30 ft.	Galvanized Steel	Polymer	Carabiner	UFC401101	Included	1
H UFS310150	50 ft.	Galvanized Steel	Polymer	Carabiner	UFC401101	Included	1
J UFS480020	20 ft.	Galvanized Steel	Aluminum	Snap Hook	UFC401101	Included	1
K UFS480030	30 ft.	Galvanized Steel	Aluminum	Snap Hook	UFC401101	Included	1
L UFS480050	50 ft.	Galvanized Steel	Aluminum	Snap Hook	UFC401101	Included	1



UFC401101 Carabiner included with every BRUTE™ SRL and SRL-LE. Tag Lines also included for all models 18 ft. and longer.

BRUTE™
SRL SERIES - WIRE CABLE

BRUTE™
SRL SERIES
AL™
ALUMINUM

Rugged Durable Aluminum Housing



Class
1
Anchor at or above dorsal D-ring

Class
1
Anchor at or above dorsal D-ring



Class
1
Anchor at or above dorsal D-ring

Class
1
Anchor at or above dorsal D-ring

Class
1
Anchor at or above dorsal D-ring

SELF-RETRACTING LIFELINES

BRUTE™ SRL Series - Web | Overhead

	Model	Length	Cable Type	Attachment End	Installation Carabiner	Tag Line	Class
A	UFS350011	11 ft.	Webbing	Snap Hook	UFC401101		1
B	UFS350025	25 ft.	Webbing	Snap Hook	UFC401101	Included	1

BRUTE™

SRL SERIES - WEB



Class
1
Anchor at or above dorsal D-ring



Class
1
Anchor at or above dorsal D-ring



UFC401101 Carabiner included with every BRUTE™ SRL and SRL-LE. Tag Lines also included for all models 18 ft. and longer.

SELF-RETRACTING LIFELINES

BRUTE™ SRL Series - Web | Personal

Model	Length	Lifeline	Attachment End	Installation Carabiner	Class
C UFS359506	9 ft. (6 ft. internal, 3 ft. external)	Hi-Abrasion Resistant Dyneema Web	Tie-back Hook	UFC409151	1
D UFS359506D	Twin 9 ft. (6 ft. internal, 3 ft. external)	Hi-Abrasion Resistant Dyneema Web	Tie-back Hooks	UFC409151	1

BRUTE™

SRL SERIES - WEB

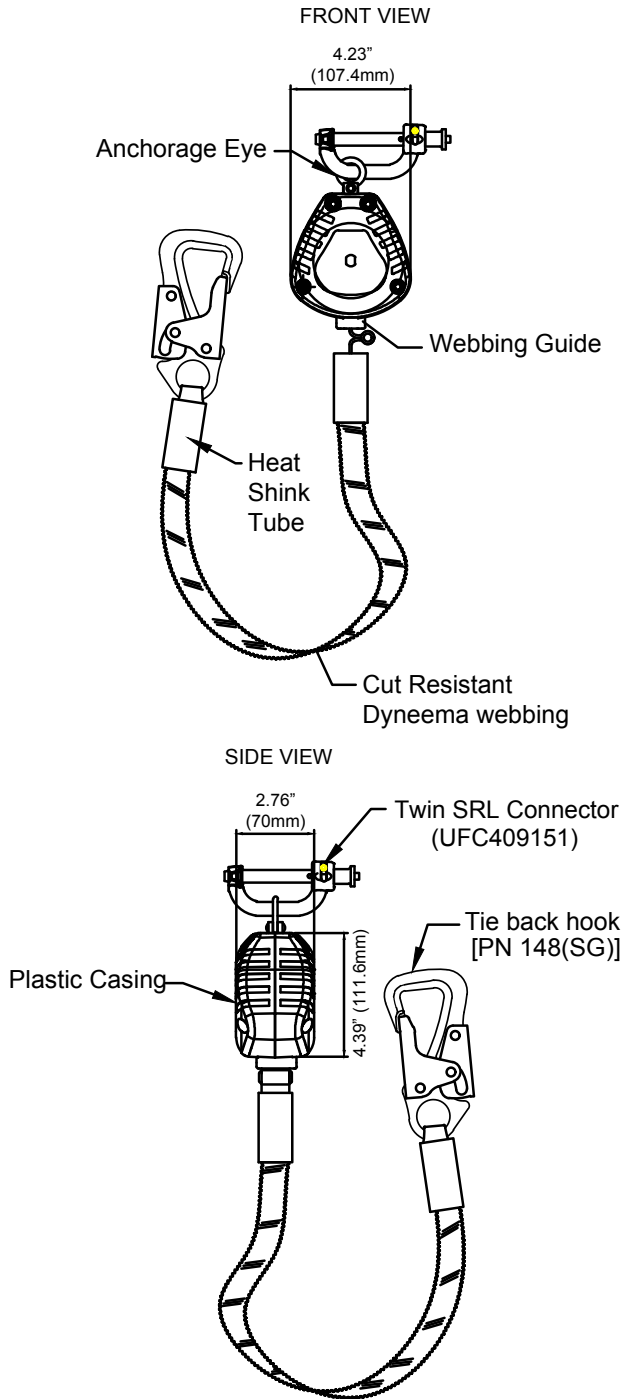

Meets or Exceeds ANSI Z359.14-2021 Class 1

SELF-RETRACTING LIFELINES

BRUTE™ LE SRL Series | Leading Edge (LE) Rated

BRUTE™ SRL SERIES

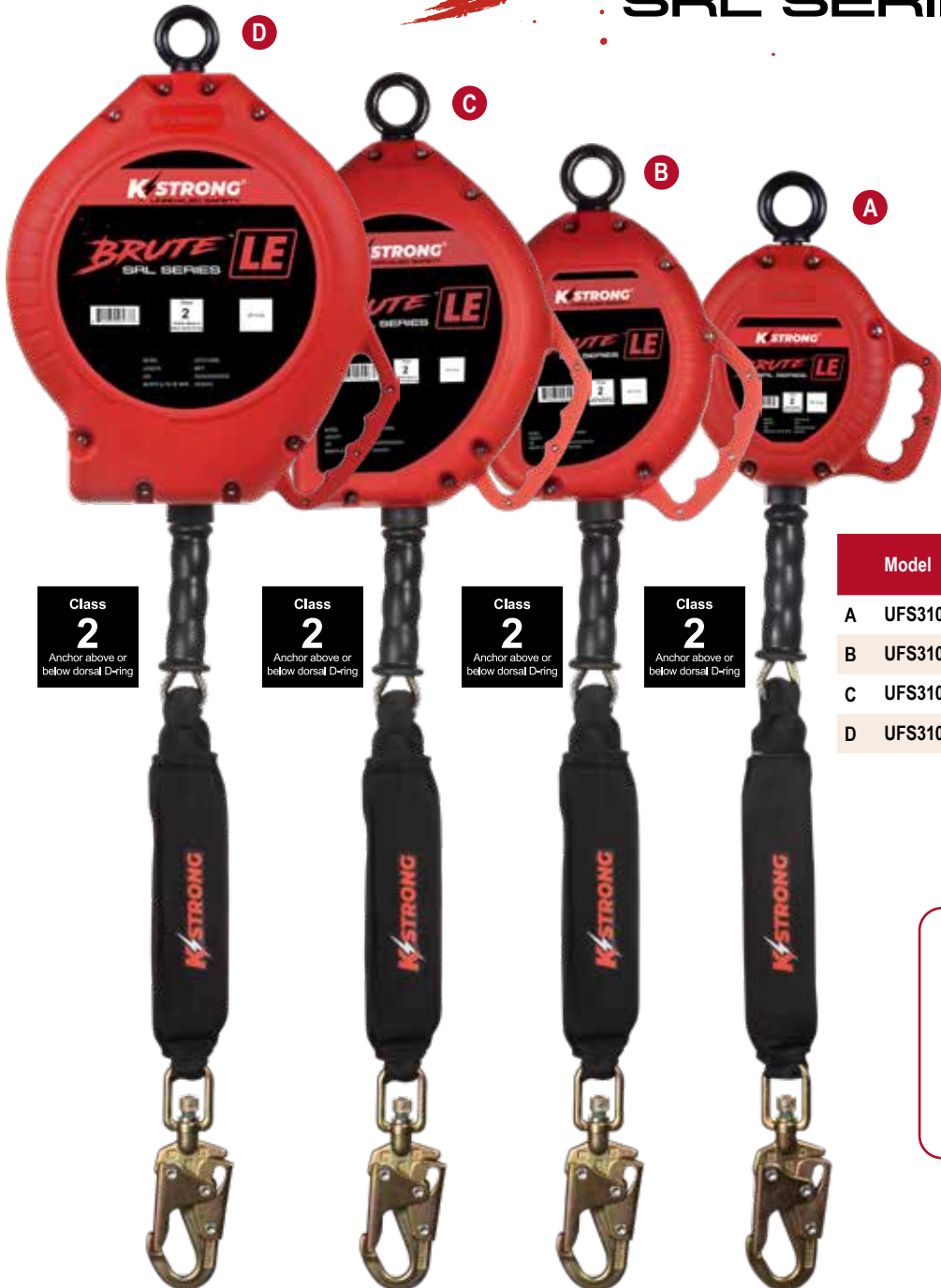
Class 2
Anchor above or below dorsal D-ring

Class 2
Anchor above or below dorsal D-ring

Class 2
Anchor above or below dorsal D-ring

Class 2
Anchor above or below dorsal D-ring

	Model	Length	Installation Carabiner	Tag Line	Class
A	UFS310018L	18 ft.	UFC401101	Included	2
B	UFS310025L	25 ft.	UFC401101	Included	2
C	UFS310050L	50 ft.	UFC401101	Included	2
D	UFS310080L	80 ft.	UFC401101	Included	2



UFC401101 Carabiner included with every BRUTE™ SRL and SRL-LE. Tag Lines also included for all models 18 ft. and longer.

SELF-RETRACTING LIFELINES

BRUTE-AL™ LE SRL Series

Leading Edge (LE) Rated

Rugged Durable Aluminum Housing



G

F

E

Class
2
Anchor above or below dorsal D-ring

Class
2
Anchor above or below dorsal D-ring

Class
2
Anchor above or below dorsal D-ring

Model	Length	Installation Carabiner	Tag Line	Class
E UFS480020L	20 ft. LE	UFC401101	Included	2
F UFS480025L	25 ft. LE	UFC401101	Included	2
G UFS480050L	50 ft. LE	UFC401101	Included	2



UFC401101 Carabiner included with every BRUTE™ SRL and SRL-LE. Tag Lines also included for all models 18 ft. and longer.

SELF-RETRACTING LIFELINES

BRUTE Backer™ LE SRL Series | Leading Edge (LE) Rated

BRUTE™ BACKER™ LE

WE'VE GOT YOUR BACK.



Class 2
Anchor above or below dorsal D-ring



Class 2
Anchor above or below dorsal D-ring



Class 2
Anchor above or below dorsal D-ring



Class 2
Anchor above or below dorsal D-ring

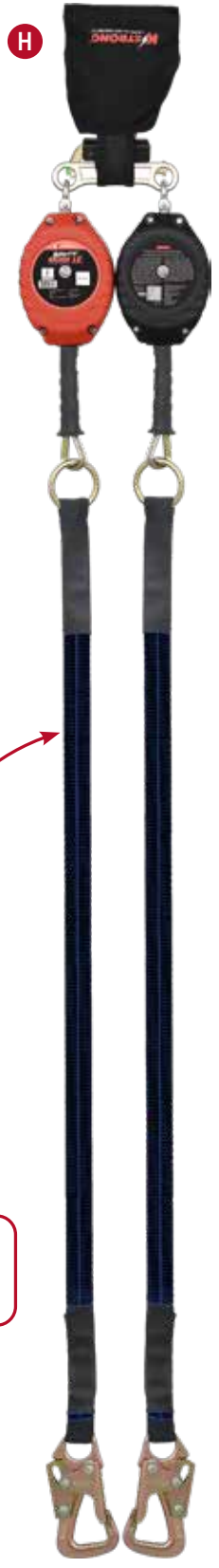

Class 2
Anchor above or below dorsal D-ring

Tie-Back Webbing

SELF-RETRACTING LIFELINES

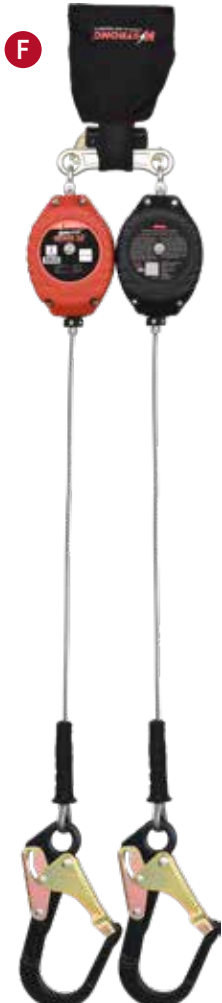
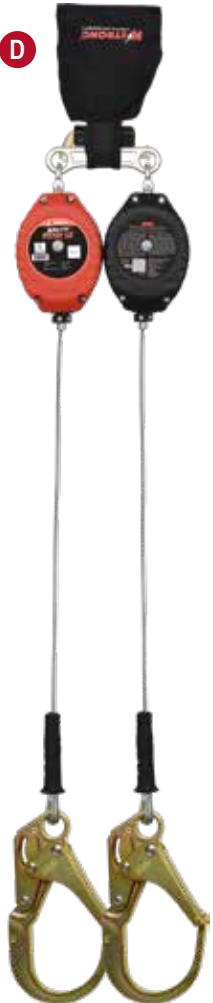
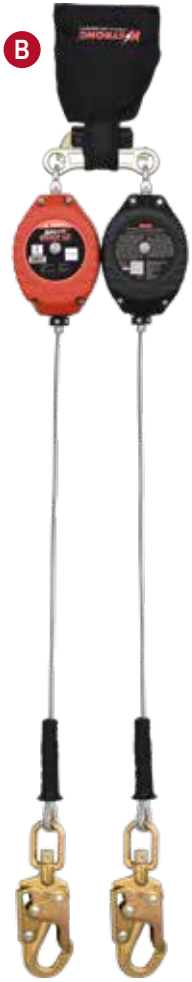

Closed

Open

Class
2
Anchor above or below dorsal D-ring

Class
2
Anchor above or below dorsal D-ring

Class
2
Anchor above or below dorsal D-ring

	Model	Length	Description	Class
A	UFS310206L	8.5 ft.	Steel Snap Hook; comes with UFC409151	2
B	UFS310206LD	8.5 ft.	Twin Model - Steel Snap Hook; comes with UFC409151	2
C	UFS314006L	8.5 ft.	Steel Rebar Hook; comes with UFC409151	2
D	UFS314006LD	8.5 ft.	Twin Model - Steel Rebar Hook; comes with UFC409151	2
E	UFS316106L	8.5 ft.	Aluminum Rebar Hook; comes with UFC409151	2
F	UFS316106LD	8.5 ft.	Twin Model - Aluminum Rebar Hook; comes with UFC409151	2
G	UFS319006L	8.5 ft.	Tie-back Hook; comes with UFC409151	2
H	UFS319006LD	8.5 ft.	Twin Model - Tie-back Hook; comes with UFC409151	2
J	UFC409151		Twin/Single Connector (Steel Pin)	



SELF-RETRACTING LIFELINES

BRUTE Backer™ LE SRL Series | Leading Edge Web



Model	Length	Description	Class
A	UFS350206L	8.5 ft. Steel Snap Hook; comes with UFC409151	2
B	UFS350206LD	8.5 ft. Twin Model - Steel Snap Hook; comes with UFC409151	2
C	UFS354006L	8.5 ft. Steel Rebar Hook; comes with UFC409151	2
D	UFS354006LD	8.5 ft. Twin Model - Steel Rebar Hook; comes with UFC409151	2
E	UFS356106L	8.5 ft. Aluminum Rebar Hook; comes with UFC409151	2
F	UFS356106LD	8.5 ft. Twin Model - Aluminum Rebar Hook; comes with UFC409151	2
G	UFC409151	Twin/Single Connector (Steel Pin)	

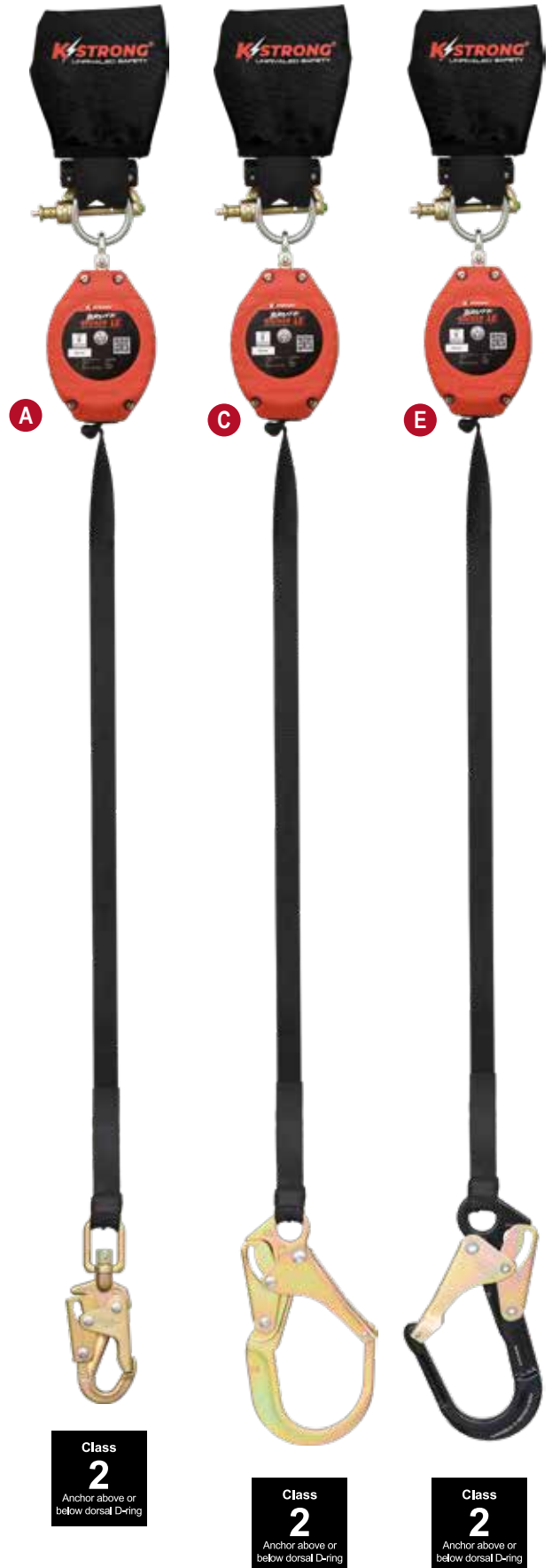

SELF-RETRACTING LIFELINES



B

Class
2
Anchor above or
below dorsal D-ring



D

Class
2
Anchor above or
below dorsal D-ring



F

Class
2
Anchor above or
below dorsal D-ring

SELF-RETRACTING LIFELINES

BRUTE™ Sealed Series | Sealed Block SRL's (IP68 Level of IEC 60529) with Stainless Steel Cable and Snap Hook

BRUTE™ SEALED SERIES



**IP68 Level
of IEC 60529**

Class
1
Anchor at or
above dorsal D-ring

Class
1
Anchor at or
above dorsal D-ring

	Model	Length	Class
	G	UFS570030	30 ft. 1
	H	UFS570050	50 ft. 1
	Not Shown	UFS570080	80 ft. 1
Tagline	AFZ830025	27 ft.	
Tagline	AFZ830050	52 ft.	
Tagline	AFZ830100	102 ft.	



Stainless Steel Carabiner included with every BRUTE™ Sealed SRL. Tag Lines also included.

SELF-RETRACTING LIFELINES

KStrong® New SRL ANSI Standard

New ANSI Standards for Fall Protection SRLs

ANSI/ASSP Z359.14-2021 standard has been recently updated to minimize confusion in the market as to proper use of Self-Retracting Lifelines (SRLs) in relation to anchor height requirements. Beginning in April 2022, KStrong began transitioning manufacturing of SRLs from current ANSI Class A/Class B to the new Class 1/Class 2 standard.

Classification Changes

SRLs will now be classified by two new class ranges: Class 1 and Class 2. The table below identifies Class 1 SRLs that are only to be used only on overhead anchorages and are subjected to a max free fall of 2 feet or less. Class 2 SRLs can only be used in applications where overhead anchorages may not be accessible and a structural edge is used instead; these can withstand a free fall of no more than 6 feet over an edge.

ANSI Z359.14-2014 (Old)	ANSI Z359.14-2021 (New)
Class A -Tested overhead with 282 lb. weight -Must arrest fall within 24" -Average force less than 1,350 lbs.	Class 1 -Tested overhead with 310 lb. weight -Must arrest fall within 42" -Average force less than 1,350 lbs.
Class B -Tested overhead with 282 lb. weight -Must arrest fall within 54" -Average force less than 900 lbs.	Class 2 -Meets Class 1 standards -Tested at foot level with 310 lb. weight -Arrest distance printed on label and instructions

SRLs must have Class 1 or Class 2 clearly labeled on the product as per the image below.

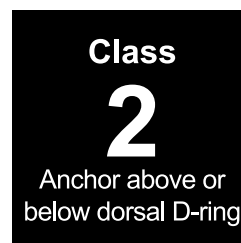
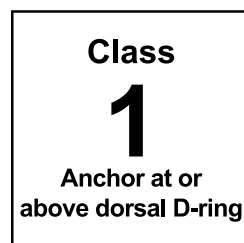

Also included in the ANSI Z359.14-2021 standard are testing requirements for a SRL-P, which is a self-retracting lanyard worn by the user on a full-body harness to be used as a fall arrest connector. Standard specifics are detailed in the table below.

Class 1 and Class 2 KStrong products are now available in the United States.

BODY WEAR

When it comes to your fall protection equipment, a full-body harness is one of the most important equipment choices you can make. While KStrong harnesses are built to meet or exceed ANSI standards and OSHA regulations, we've also designed comfort, lumbar support, positioning D-rings and accessibility into our body wear to provide workers with continued freedom of movement, sustained safety, and improved productivity while working at height or in confined spaces. KStrong Essential™, Elite™, and Epic™ harnesses provide workers with a very high degree of confidence, which directly affects the worker's productivity. While many of our safety harnesses can be used on most jobs, we also manufacture innovative full-body harnesses for specific uses within different industries such as Oil and Gas, Utility, Tower, and Wind Energy.

KAPTURE™ HARNESSES SERIES

Kapture™ Essential | 3-point Adjustment | Available Sizes: Universal (S-L), L-XL

KAPTURE™ ESSENTIAL
LV1 || FULL BODY HARNESSES

UFH10101G | Tongue Buckle Legs

UFH16101G | Removable Shoulder Padding

UFH10101P | Pass-Thru Legs



Kapture™ Essential | 3-point Adjustment | Available Sizes: Universal (S-L), L-XL

KAPTURE™ ESSENTIAL
LV1 || FULL BODY HARNESSES

UFH10131G | Tongue Buckle Legs & Side D-Rings

UFH10131P | Pass-Thru Legs & Side D-Rings



BODY WEAR

Kapture™ Essential | 3-point Adjustment | Available Sizes: Universal (S-L), L-XL

KAPTURE™ ESSENTIAL
LV1 || FULL BODY HARNESS

UFH10102G | Tongue Buckle Legs, Dorsal D-Ring with Sewn In 18" Extension O-Ring



UFH10102P | Pass-Thru Legs, Dorsal D-Ring with Sewn In 18" Extension O-Ring



Kapture™ Essential+ | 5-point Adjustment | Available Sizes: S-M, M-L, L-XL, XL-2XL

KAPTURE™ +PLUS
LV1 || ESSENTIAL

UFH16201GP | Tongue Buckle Legs & with Removable Back/Shoulder Pad



UFH16201GP(BL) | Web Loop Added Under Dorsal D-ring, Tongue Buckle Legs & with Removable Back/Shoulder Pad



BODY WEAR

Kapture™ Essential+ | 5-point Adjustment | Available Sizes: S-M, M-L, L-XL, XL-2XL, 2XL-3XL

UFH16001GP | Tongue Buckle Legs

KAPTURE™
LV1 || **ESSENTIAL**
+PLUS



Kapture™ Essential+ | 5-point Adjustment | Available Sizes: S-M, M-L, L-XL, XL-2XL

UFH16231GP | Back/Shoulder Pad and Waist Belt, 3 D-rings, Tongue Buckle Legs



Kapture™ Elite | 5-point Adjustment | Available Sizes: S-M, M-L, L-XL, XL-2XL, 2XL-3XL

UFH10201G | Tongue Buckle Legs

UFH10201GQ | QC Chest, Tongue Buckle Legs

Kapture™ Elite | 5-point Adjustment | Available Sizes: S-M, M-L, L-XL

UFH10201P | Pass-Thru Legs

KAPTURE™
LV2 || **FULL BODY HARNESS**
ELITE



BODY WEAR

Kapture™ Elite | 5-point Adjustment | Available Sizes: S-M, M-L, L-XL

UFH10231G | Tongue Buckle Legs & Side D-Rings

UFH10231P | Pass-Thru Legs & Side D-Rings

KAPTURE™ ELITE
LV2 || FULL BODY HARNESS



Kapture™ Elite | 5-point Adjustment | Available Sizes: S-M, M-L, L-XL

UFH10251G | Climbing FBH, TB Legs, Front & Side D-rings

UFH10251P | Climbing FBH, PT Legs, Front & Side D-rings

KAPTURE™ ELITE
LV2 || FULL BODY HARNESS



BODY WEAR

Kapture™ Elite | 5-point Adjustment | Available Sizes: S-M, M-L, L-XL, XL-2XL, 2XL-3XL

KAPTURE™ ELITE
LV2 || FULL BODY HARNESS

UFH10211G | Front D-Ring, Tongue Buckle Legs



UFH10241G | Front D-Ring, Shoulder D-rings, Tongue Buckle Legs



UFH10211P | Front D-Ring, Pass-Thru Legs



Kapture™ Elite | 5-point Adjustment | Available Sizes: S-M, M-L, L-XL, XL-2XL, 2XL-3XL

KAPTURE™ ELITE
LV2 || FULL BODY HARNESS

UFH10252P | Pass-Thru Legs, Front & Side D-rings



Kapture™ Elite | 5-point Adjustment | Available Sizes: S-M, M-L, L-XL, XL-2XL

UFH10261G | Tongue Buckle Legs, Front, Side, and Shoulder D-rings



Kapture™ Elite+ & Epic Series featuring D-Ring Plus™



Step 1:



Open Dual Connector.

Step 2:



Insert Dual Connector into D-Ring Plus™.

Step 3:



Fully close/lock Dual Connector.

Step 4:



Fast, easy, and safe. You're all finished.

Kapture™ Elite+ | 5-point Adjustment, Shoulder/Back Pad | Available Sizes: S-M, M-L, L-XL, XL-2XL, 2XL-3XL

Kapture™ Elite+ | 5-point Adjustment, Shoulder/Back Pad | Available Sizes: S-M, M-L, L-XL, XL-2XL

UFH15201GQ | Tongue Buckle Legs, Quick Connect Chest, Enhanced Dorsal D-ring

UFZ850100 Trauma Relief Straps Included

KAPTURE™
LV2 || ELITE
+PLUS



UFH15203GQ | Spring Torso Adjusters, Enhanced Aluminum Dorsal D-ring Plus, Quick Connect Chest, Multi-Flex Feature for Ease of Mobility, Tongue Buckle Legs

UFZ850100 Trauma Relief Straps Included

KAPTURE™
LV2 || ELITE
+PLUS



BODY WEAR

Kapture™ Elite+ | 5-point Adjust., Comfort Shoulder/Back Pad | Available Sizes: S-M, M-L, L-XL, XL-2XL

UFH152011GQ | Front D-Ring, Tongue Buckle Legs, Quick Connect Chest

+PLUS
KAPTURE™
LV2 || ELITE



UFZ850100 Trauma Relief Straps Included

Kapture™ Elite+ | 5-point, Comfort Shoulder/Back Pad | Available Sizes: S-M, M-L, L-XL, XL-2XL, 2XL-3XL

UFH15201Q | Quick Connect Chest and Leg Buckles

+PLUS
KAPTURE™
LV2 || ELITE



UFZ850100 Trauma Relief Straps Included

Kapture™ Elite+ | 5-point Adjustment, Comfort Shoulder/Back Pad | Available Sizes: S-M, M-L, L-XL, XL-2XL

UFH15231Q | Quick Connect Chest and Leg Buckles, Side D-Rings

+PLUS
KAPTURE™
LV2 || ELITE



UFZ850100 Trauma Relief Straps Included

UFH15231GQ | Quick Connect Chest, Tongue Buckle Legs, Side D-Rings



UFZ850100 Trauma Relief Straps Included

BODY WEAR

Kapture™ Epic | 5-point Adjustment, Comfort Back Pad & Belt | Available Sizes: S-M, M-L, L-XL, XL-2XL, 2XL-3XL

UFH10332G | Quick Connect Chest, Tongue Buckle Legs, Enhanced Dorsal D-ring Plus, Side D-rings

UFH10332P | Quick Connect Chest & Legs, Enhanced Dorsal D-ring Plus, Side D-rings

KAPTURE™ EPIC
LV3 || FULL BODY HARNESS



Kapture™ Epic | 5-point Adjustment, Comfort Back Pad & Belt | Available Sizes: S-M, M-L, L-XL, XL-2XL

Kapture™ Element | 5-point Adjustment, Revolta™ Oil and Water Repellent Webbing | Available Sizes: S-M, M-L, L-XL, XL-2XL

UFH10341G | Quick Connect Chest, Tongue Buckle Legs, Enhanced Dorsal D-ring Plus, Front & Side D-rings

UFH10801GQ | Quick Connect Chest, Tongue Buckle Legs, Enhanced Dorsal D-ring Plus

KAPTURE™ EPIC
LV3 || FULL BODY HARNESS

KAPTURE™ ELEMENT
LV4 || FULL BODY HARNESS



BODY WEAR

Kapture™ Element | 5-point Adjustment,
 Revolta™ Oil and Water Repellent Webbing
 Available Sizes: S-M, M-L, L-XL, XL-2XL

UFH10802Q | Back/Shoulder Pad, Quick Connect Chest & Legs,
 Enhanced Dorsal D-ring Plus, Trauma Relief Straps

KAPTURE™ ELEMENT
 LV4 || FULL BODY HARNESS



UFZ850100 Trauma Relief Straps Included

Kapture™ Element | 5-point Adjustment,
 Revolta™ Oil and Water Repellent Webbing
 Available Sizes: S-M, M-L, L-XL, XL-2XL

UFH10811GQ | Quick Connect Chest, Tongue Buckle Legs, Enhanced
 Dorsal D-ring Plus, Front D-ring

KAPTURE™ ELEMENT
 LV4 || FULL BODY HARNESS



Kapture™ Element | Arc Flash Rated 5-point Adjustment | Available Sizes: Universal (S-L), L-XL

UFH10700P | Mating Buckle Legs & Chest

UFH10701P | Mating Buckle Legs & Chest, Side D-rings

KAPTURE™ ELEMENT
 LV4 || FULL BODY HARNESS



K/STRONG™
ARC FLASH
 RATED
 ASTM F887-18



K/STRONG™
ARC FLASH
 RATED
 ASTM F887-18

BODY WEAR

Kapture™ Element | Arc Flash Rated 5-point Adjustment | Available Sizes: Universal (S-L), L-XL

KAPTURE™ ELEMENT
LV4 II FULL BODY HARNESS

UFH10710P | Mating Buckle Legs & Chest, Front D-Ring



UFH10711P | Mating Buckle Legs & Chest, Web Loop Dorsal and Front D-rings



Kapture™ Element | Arc Flash Rated 5-point Adjustment, Back/Shoulder Pad | Available Sizes: Universal (S-L), L-XL

KAPTURE™ ELEMENT
LV4 II FULL BODY HARNESS

UFH10731P | Padded Belt, MB Legs & Chest, Side D-rings



UFH10732P | Padded Belt, MB Legs & Chest, Front & Side D-rings



BODY WEAR

Kapture™ Element | Welding with FR Webbing, 5-point Adjustment | Available Sizes: S-M, M-L, L-XL, XL-2XL

UFH19902GQFR | Quick Connect Chest, Tongue Buckle Legs, Spring Roller Buckles

UFH19902PFR | MB Legs & Chest, Spring Roller Buckles

KAPTURE™ ELEMENT
LV4 || FULL BODY HARNESS



Kapture™ Element | Welding with FR Webbing, 5-point Adjustment | Available Sizes: S-M, M-L, L-XL, XL-2XL

UFH19902QFR | Quick Connect Legs & Chest

UFH19903PQFR | Quick Connect Legs, MB Chest, Spring Roller Buckles, Side D-rings

KAPTURE™ ELEMENT
LV4 || FULL BODY HARNESS



BODY WEAR

Kapture™ Element | Oil & Gas Derrick Series, 5-point Adjustment | Available Sizes: S-M, M-L, L-XL, XL-2XL

KAPTURE™ ELEMENT
LV4 || FULL BODY HARNESS

UFH90131G | Tongue Buckle Legs & Side D-Rings



UFH90141G | Tongue Buckle Legs & Side D-Rings, Dorsal D-Ring with Sewn In 18" Extension D-Ring



Kapture™ Element | Oil & Gas Derrick Series, 5-point Adjustment | Available Sizes: S-M, M-L, L-XL, XL-2XL

KAPTURE™ ELEMENT
LV4 || FULL BODY HARNESS

UFH90341G | Comfort Shoulder/Back Pad with Padded Belt, Tongue Buckle Legs & Side D-Rings, Back Belt D-Ring and Dorsal D-Ring with Sewn In 18" Extension D-Ring, Trauma Relief Straps



UFH90471G | Padded Belt, Tongue Buckle Legs & Side D-Rings, Front and Dorsal D-Ring with Sewn In 18" Extension D-Ring, Removable Bosun Chair



BODY WEAR

Kapture™ Element | Oil & Gas Derrick Series Accessories

UFZ910001 | Oil and Gas Derrick Belly Belt with Two Connector Straps



UFZ910005 | Oil and Gas Derrick Belly Belt with Two Connector Buckles



UFZ920001 | Bosun Chair with Board, Lifting D-rings, Tool Clips



UFZ920011 | Bosun Chair with Padded Board, Padded Belt, Lifting D-rings, Tool Clips



Kapture™ Belts | Padded Waist Tool Belts with D-Rings

UFZ840020 | 1 Rear Restraint D-ring with Removable Tool Belt



UFZ840010 | 2 Work Positioning Side D-rings with Removable Tool Belt



BODY WEAR

Harness Accessories

UFZ850100 | Trauma Step-Up Relief; Retrofits to Most Harnesses

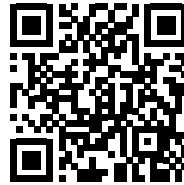

Instructional Video
Scan with camera to view a quick and informative safety video on this product.

Harness Accessories

UFZ801001 | Removable Shoulder Yoke Comfort Pad for use with full body harnesses

UFZ800200 | Replacement Lanyard Keeper with Large Ring

UFZ200101 | Kit Bag - Small



Harness Accessories

UFZ801011 | 54" Removable Tool Belt

UFZ801012 | 60" Removable Tool Belt



Belt & Leg Strap Sizing

Harness Size	Waist Circumference (in.)	Leg Circumference (in.)
Small - Medium	*Belt not provided in this size	24 - 37
Medium - Large	*Belt not provided in this size	24 - 39
Universal (Small - Large)	33 - 46	27 - 42
Large - X-Large	33 - 49	27 - 43
X-Large - 2X-Large	33 - 50	27 - 45

BODY WEAR

Harness Accessories

UFZ800100 | 18" Clear Pack SAL with snap hook and D-ring

UFZ802001 | 18" Lanyard extender with snap hook, other end O-ring

UFZ800501 | 20" D-ring extender with loop, other end D-ring



Harness Features Chart

Kapture™ Series	Model	Adjustment Points & Special Feature(s)	D-Ring Configuration	Leg Straps			Belt	Pads	Available Sizes					Minimum Standards Met
				Pass Thru	Tongue Buckle	Quick Connect			Universal (S - L)	S - M	M - L	L - XL	XL - 2XL	
Essential	UFH10101P	3	Back (Dorsal)	⚡					⚡			⚡		OSHA & ANSI Z359.11-2014
Essential	UFH10101G	3	Back (Dorsal)		⚡				⚡			⚡		OSHA & ANSI Z359.11-2014
Essential	UFH16101G	3	Back (Dorsal)		⚡			Removable Shoulders & Back	⚡			⚡		OSHA & ANSI Z359.11-2014
Essential	UFH10102P	3	Back (Dorsal) with 18" Ext. O-ring	⚡					⚡			⚡		OSHA & ANSI Z359.11-2014
Essential	UFH10102G	3	Back (Dorsal) with 18" Ext. O-ring		⚡				⚡			⚡		OSHA & ANSI Z359.11-2014
Essential	UFH10131P	3	Back (Dorsal) & Sides	⚡					⚡			⚡		OSHA & ANSI Z359.11-2014
Essential	UFH10131G	3	Back (Dorsal) & Sides		⚡				⚡			⚡		OSHA & ANSI Z359.11-2014
Essential+	UFH16001GP	5	Back (Dorsal)		⚡					⚡	⚡	⚡	XL-2X, 2X-3X	OSHA & ANSI Z359.11-2014
Essential+	UFH16201GP	5	Back (Dorsal)		⚡			Removable Shoulders & Back		⚡	⚡	⚡	⚡	OSHA & ANSI Z359.11-2021
Essential+	UFH16201GP (BL)	5	Back (Dorsal) with Web Loop		⚡			Removable Shoulders & Back		⚡	⚡	⚡	⚡	OSHA & ANSI Z359.11-2021
Essential+	UFH16231GP	5	Back (Dorsal) & Sides		⚡		⚡	Shoulders & Back		⚡	⚡	⚡	⚡	OSHA & ANSI Z359.11-2021

BODY WEAR

Harness Features Chart

Kapture™ Series	Model	Adjustment Points & Special Feature(s)	D-Ring Configuration	Leg Straps			Belt	Pads	Available Sizes				Minimum Standards Met
				Pass Thru	Tongue Buckle	Quick Connect			Universal (S - L)	S - M	M - L	L - XL	
Elite	UFH10201P	5	Back (Dorsal)	⚡					⚡	⚡	⚡		OSHA & ANSI Z359.11-2014
Elite	UFH10201G	5	Back (Dorsal)		⚡				⚡	⚡	⚡	XL-2X, 2X-3X	OSHA & ANSI Z359.11-2021
Elite	UFH10201GQ	5	Back (Dorsal)		⚡	Chest			⚡	⚡	⚡	XL-2X, 2X-3X	OSHA & ANSI Z359.11-2014
Elite	UFH10211P	5	Back (Dorsal), Front	⚡					⚡	⚡	⚡	XL-2X, 2X-3X	OSHA & ANSI Z359.11-2014
Elite	UFH10211G	5	Back (Dorsal), Front		⚡				⚡	⚡	⚡	XL-2X, 2X-3X	OSHA & ANSI Z359.11-2021
Elite	UFH10231P	5	Back (Dorsal) & Sides	⚡					⚡	⚡	⚡		OSHA & ANSI Z359.11-2014
Elite	UFH10231G	5	Back (Dorsal) & Sides		⚡				⚡	⚡	⚡		OSHA & ANSI Z359.11-2014
Elite	UFH10241G	5	Back (Dorsal), Front, Shoulder		⚡				⚡	⚡	⚡	XL-2X, 2X-3X	OSHA & ANSI Z359.11-2021
Elite	UFH10251P	5, Crossover Design	Back (Dorsal), Front & Sides	⚡					⚡	⚡	⚡		OSHA & ANSI Z359.11-2021
Elite	UFH10251G	5, Crossover Design	Back (Dorsal), Front & Sides		⚡				⚡	⚡	⚡		OSHA & ANSI Z359.11-2021
Elite	UFH10252P	5	Back (Dorsal), Front & Sides	⚡					⚡	⚡	⚡	XL-2X, 2X-3X	OSHA & ANSI Z359.11-2014
Elite	UFH10261G	5	Back (Dorsal), Front, Shoulder, & Sides		⚡				⚡	⚡	⚡	⚡	OSHA & ANSI Z359.11-2021
Elite+	UFH15201GQ	5	Enhanced Back (Dorsal)		⚡	Chest		Shoulders & Back	⚡	⚡	⚡	XL-2X, 2X-3X	OSHA & ANSI Z359.11-2021
Elite+	UFH152011GQ	5	Enhanced Back (Dorsal), Front		⚡	Chest		Shoulders & Back	⚡	⚡	⚡	⚡	OSHA & ANSI Z359.11-2021
Elite+	UFH15201Q	5	Enhanced Back (Dorsal)			⚡ + Chest		Shoulders & Back	⚡	⚡	⚡	XL-2X, 2X-3X	OSHA & ANSI Z359.11-2014
Elite+	UFH15203GQ	5, Multi-Flex, Spring Torso Adjusters	Enhanced Back (Dorsal)		⚡	Chest		Removable Shoulders & Back	⚡	⚡	⚡	⚡	OSHA & ANSI Z359.11-2021
Elite+	UFH15231Q	5	Enhanced Back (Dorsal) & Sides			⚡ + Chest		Shoulders & Back	⚡	⚡	⚡	⚡	OSHA & ANSI Z359.11-2014
Elite+	UFH15231GQ	5	Enhanced Back (Dorsal) & Sides		⚡	Chest		Shoulders & Back	⚡	⚡	⚡	⚡	OSHA & ANSI Z359.11-2021
Epic	UFH10332P	5	Enhanced Back (Dorsal) & Sides			⚡ + Chest	⚡	Shoulders & Back	⚡	⚡	⚡	XL-2X, 2X-3X	OSHA & ANSI Z359.11-2021
Epic	UFH10332G	5	Enhanced Back (Dorsal) & Sides		⚡	Chest	⚡	Shoulders & Back	⚡	⚡	⚡	XL-2X, 2X-3X	OSHA & ANSI Z359.11-2021
Epic	UFH10341G	5	Enhanced Back (Dorsal), Front & Sides		⚡	Chest	⚡	Shoulders & Back	⚡	⚡	⚡	⚡	OSHA & ANSI Z359.11-2021

BODY WEAR

Harness Features Chart

Kapture™ Series	Model	Adjustment Points & Special Feature(s)	D-Ring Configuration	Leg Straps			Belt	Pads	Available Sizes					Minimum Standards Met
				Pass Thru	Tongue Buckle	Quick Connect			Universal (S - L)	S - M	M - L	L - XL	XL - 2XL	
Element	UFH10801GQ	5, Revolta™ Oil and Water Repellent	Enhanced Back (Dorsal)		⚡	Chest				⚡	⚡	⚡	⚡	OSHA & ANSI Z359.11-2021
Element	UFH10802Q	5, Revolta™ Oil and Water Repellent, Trauma Relief Straps	Enhanced Back (Dorsal)			⚡ + Chest		Removable Shoulders & Back		⚡	⚡	⚡	⚡	OSHA & ANSI Z359.11-2014
Element	UFH10811GQ	5, Revolta™ Oil and Water Repellent	Enhanced Back (Dorsal), Front		⚡	Chest				⚡	⚡	⚡	⚡	OSHA & ANSI Z359.11-2021
Element	UFH10700P	5, Arc Flash Rated	Back (Dorsal)	⚡					⚡			⚡		OSHA & ANSI Z359.11-2021, ASTM F887-20
Element	UFH10701P	5, Arc Flash Rated	Back (Dorsal) & Sides	⚡					⚡			⚡		OSHA & ANSI Z359.11-2021, ASTM F887-20
Element	UFH10710P	5, Arc Flash Rated	Back (Dorsal), Front	⚡					⚡			⚡		OSHA & ANSI Z359.11-2021, ASTM F887-20
Element	UFH10711P	5, Arc Flash Rated	Back (Dorsal), Front Web Loops	⚡					⚡			⚡		OSHA & ANSI Z359.11-2021, ASTM F887-20
Element	UFH10731P	5, Arc Flash Rated	Back (Dorsal) & Sides	⚡			⚡	Removable Shoulders & Back	⚡			⚡		OSHA & ANSI Z359.11-2021, ASTM F887-20
Element	UFH10732P	5, Arc Flash Rated	Back (Dorsal), Front & Sides	⚡			⚡	Removable Shoulders & Back	⚡			⚡		OSHA & ANSI Z359.11-2021, ASTM F887-20
Element	UFH19902GQFR	5, FR Webbing, Spring Roller Buckles	Back (Dorsal)		⚡	Chest				⚡	⚡	⚡	⚡	OSHA & ANSI Z359.11-2014
Element	UFH19902PFR	5, FR Webbing, Spring Roller Buckles	Back (Dorsal)	⚡						⚡	⚡	⚡	⚡	OSHA & ANSI Z359.11-2014
Element	UFH19902QFR	5, FR Webbing	Back (Dorsal)			⚡ + Chest				⚡	⚡	⚡	⚡	OSHA & ANSI Z359.11-2014
Element	UFH19903PQFR	5, FR Webbing, Spring Roller Buckles	Back (Dorsal) & Sides	Chest		⚡				⚡	⚡	⚡	⚡	OSHA & ANSI Z359.11-2014
Element	UFH90131G	5, Oil & Gas Derrick	Back (Dorsal) & Sides	Chest	⚡			Small Back		⚡	⚡	⚡	⚡	OSHA & ANSI Z359.11-2014
Element	UFH90141G	5, Oil & Gas Derrick	Back (Dorsal) with 18" Ext. D-ring, Sides	Chest	⚡			Small Back		⚡	⚡	⚡	⚡	OSHA & ANSI Z359.11-2014
Element	UFH90341G	5, Oil & Gas Derrick, Trauma Relief Straps	Back (Dorsal) with 18" Ext. D-ring, Sides, Back Belt	Chest	⚡		⚡	Shoulders & Back		⚡	⚡	⚡	⚡	OSHA & ANSI Z359.11-2014
Element	UFH90471G	5, Oil & Gas Derrick	Back (Dorsal) with 18" Ext. D-ring, Front, Sides, Removable Bosun Chair	Chest	⚡		⚡	Small Back		⚡	⚡	⚡	⚡	OSHA & ANSI Z359.11-2014

BODY WEAR

Harness Sizing Chart

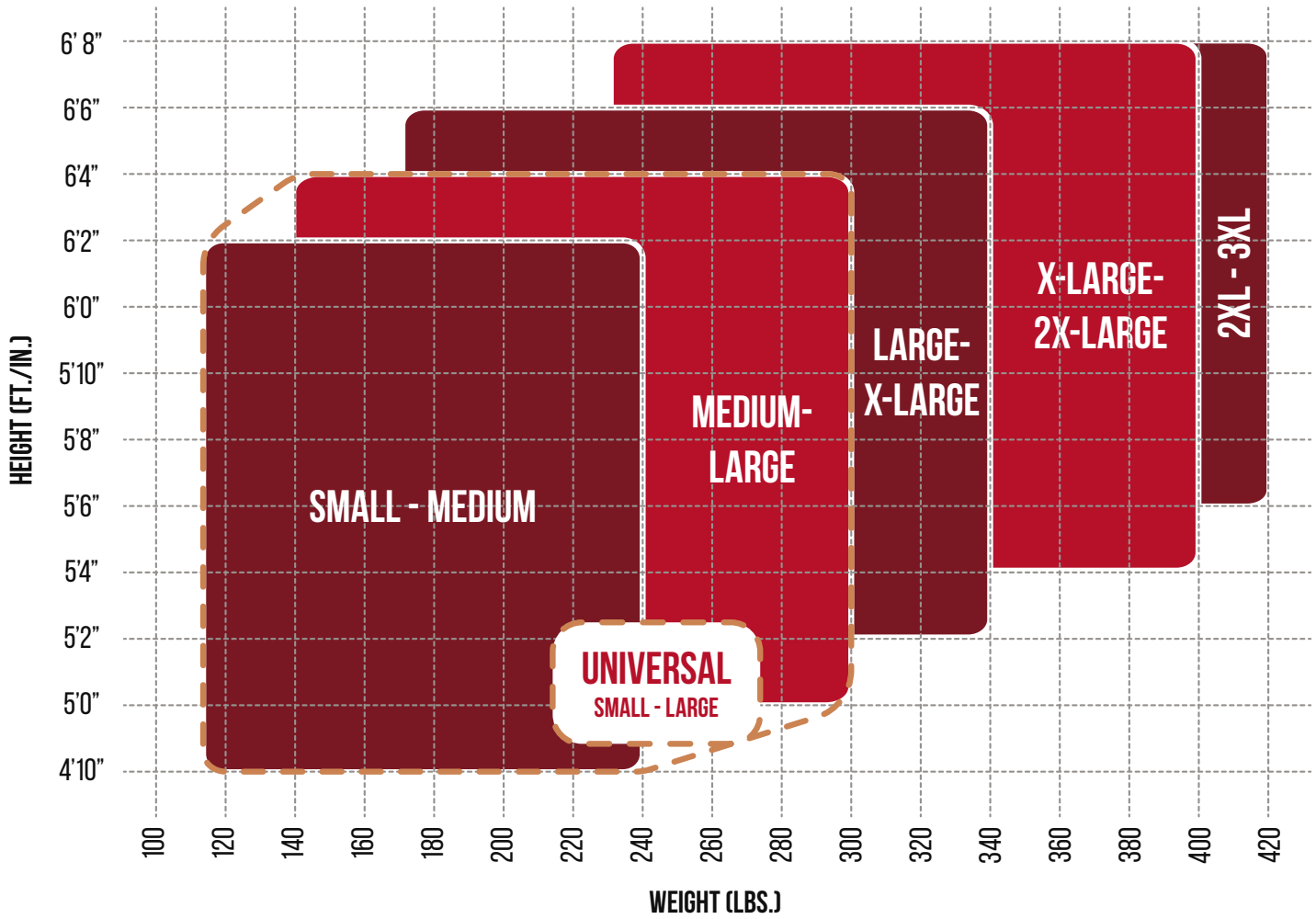

CONNECTORS

KStrong's extensive selection of connectors for fall arrest, work positioning, and restraint applications is built on years of dependable design, construction, performance, and quality through rigorous testing to provide your worker with ultimate protection. As we manufacture all our connectors in-house including all hardware (snap hooks, carabiners, etc.), you are guaranteed products of the highest quality all backed by industry-preferred Level 3 ANSI independent 3rd-party testing documentation. When you need to be connected, rest assured KStrong has the right equipment for the job!

Model	Length	Shock Absorption	Description	Model	Length	Shock Absorption	Description
A UFL204101	6 ft.	Internal	Snap Hooks	C UFL204121	6 ft.	Internal	Y with Snap Hooks
B UFL204111	6 ft.	Internal	Snap Hook & Rebar Hook	D UFL204131	6 ft.	Internal	Y with Rebar Hooks

Energy Absorbing Lanyards | 6 ft. Internal Shock Absorption



CONNECTORS

Model	Length	Shock Absorption	Description
E UFL206101	4.5 - 6 ft.	Internal - Elasticated	Snap Hooks
F UFL206111	4.5 - 6 ft.	Internal - Elasticated	Snap Hook & Rebar Hook
G UFL206121	4.5 - 6 ft.	Internal - Elasticated	Y with Snap Hooks
H UFL206131	4.5 - 6 ft.	Internal - Elasticated	Y with Rebar Hooks
J UFL206214	4.5 - 6 ft.	Internal - Elasticated	Aluminum Snap Hook & Rebar Hook
K UFL206234	4.5 - 6 ft.	Internal - Elasticated	Y with Aluminum Rebar Hooks

Energy Absorbing Lanyards | Elasticated 4.5 ft. - 6 ft.



CONNECTORS

Model	Length	Shock Absorption	Description
A UFL201101(03)	3 ft.	Clear Shock Pack	Snap Hooks
B UFL201101(04)	4 ft.	Clear Shock Pack	Snap Hooks
C UFL201101	6 ft.	Clear Shock Pack	Snap Hooks
D UFL201111	6 ft.	Clear Shock Pack	Snap Hook & Rebar Hook
E UFL201121(04)	4 ft.	Clear Shock Pack	Y with Snap Hooks
F UFL201121	6 ft.	Clear Shock Pack	Y with Snap Hooks
G UFL201131	6 ft.	Clear Shock Pack	Y with Rebar Hooks
H UFL201421	6 ft.	Clear Shock Pack	Y with Tie-back Hooks

Energy Absorbing Lanyards | 6 ft. Clear Shock Pack



CONNECTORS

Model	Length	Shock Absorption	Description	Model	Length	Shock Absorption	Description
J UFL201301	4.5 - 6 ft.	Clear Shock Pack	Adjustable with Snap Hooks	L UFL201402	6 ft.	Clear Shock Pack	Adjustable 4.5'-6' with snap hook and one tie-back hook
K UFL201331	4.5 - 6 ft.	Clear Shock Pack	Adjustable Y with Rebar Hooks	M UFL201422	6 ft.	Clear Shock Pack	Y with Tie-back Hooks & Adjustable D-rings

Energy Absorbing Lanyards | 4.5 - 6 ft. Adjustable with Clear Shock Pack



J



K

L

M

CONNECTORS

Model	Length	Shock Absorption	Description	Model	Length	Shock Absorption	Description
A UFL201601	6 ft.	Clear Shock Pack	LE Rated with Snap Hooks	C UFL201621	6 ft.	Clear Shock Pack	LE Rated Y with Snap Hooks
B UFL201611	6 ft.	Clear Shock Pack	LE Rated with Rebar Hook	D UFL201622	6 ft.	Clear Shock Pack	LE Rated Y with Rebar Hooks

Energy Absorbing Lanyards | LE Rated for up to 12 ft. Free-fall



CONNECTORS

Model	Length	Shock Absorption	Description	Model	Length	Shock Absorption	Description
E UFL201701	6 ft.	Shock Pack	Dielectric Arc Flash Rated with Snap & Rebar Hook	G UFL201740	6 ft.	Shock Pack	Dielectric Arc Flash Rated with Snap Hook & Loop
F UFL201721	6 ft.	Shock Pack	Y Dielectric Arc Flash Rated with Rebar Hooks	H UFL201750	6 ft.	Shock Pack	Y Dielectric Arc Flash Rated with Snap Hooks and Loop

Energy Absorbing Lanyards | 6 ft. Arc Flash



CONNECTORS

Model	Length	Shock Absorption	Description	Model	Length	Shock Absorption	Description
A UFL205201	6 ft.	N/A	Snap Hooks	D UFL205201(02)	2 ft.	Snap Hooks	
B UFL205215	4.5 - 6 ft.	N/A	Adjustable with Forged Steel Snap Hooks	E UFL205201(03)	3 ft.	N/A	Snap Hooks
C UFL205211	4.5 - 6 ft.	N/A	Adjustable with Snap Hooks	F UFL205401		N/A	WPL Chain Assembly
				G UFL205251		N/A	WPL Web Assembly

Work Positioning Lanyards & Devices



COMBO KITS

Harness & Lanyard Combo Kits

UFK10010 | 3 pt. FBH, MB Legs, and 6' Internal SAL with Snap Hooks | Sizes: S-L, L-XL



UFK10015 | 3 pt. FBH, MB Legs, and 6' Internal SAL with Loop & Snap Hook | Sizes: S-L, L-XL



UFK10025 | 3 pt. FBH, MB Legs, and 6' Internal SAL Twin Leg 100% Tie Off with Loop & Rebar Hooks | Sizes: S-L, L-XL



UFK20010 | 5 pt. FBH, MB Legs, and 6' Internal SAL with Snap Hooks | Sizes: S-M, M-L, L-XL



UFK20015 | 5 pt. FBH, MB Legs, and 6' Internal SAL with Loop & Snap Hook | Sizes: S-M, M-L, L-XL



UFK20025 | 5 pt. FBH, MB Legs, and 6' Internal SAL Twin Leg 100% Tie Off with Loop & Rebar Hooks | Sizes: S-M, M-L, L-XL



Harness & Lanyard Aerial Kits

UFK20510 | 5pt. FBH, TB Legs, and Micron™ SRL with Snap Hook. Includes Carabiner | Sizes: S-M, M-L, L-XL, XL-2XL, 2XL-3XL



UFK20410 | Aerial Kit with 3 pt. FBH, MB Legs, and 4.5 - 6 ft. Adjustable WPL with Snap Hooks | Sizes: S-L, L-XL



UFK23110 | Aerial Bucket Kit with 5 pt. FBH, TB Legs, and 6' Clear Pack SAL with Snap Hooks | Sizes: S-M, M-L, L-XL



ANCHORAGES

Selecting an appropriate anchorage connector for your fall arrest system is a critical element in protecting a worker from fall and confined space hazards. Designed to fit a broad scope of general and specific user applications, our offering of anchorage connectors meets those requirements head-on by providing a secure point of attachment. Fall arrest anchors are identified by what they connect to such as steel anchors, concrete anchors, roof anchors and specialty safety anchors designed for your unique applications. Your worker can work with confidence knowing each connector is rigorously Level 3 ANSI tested and meets or exceeds industry standards. For 2024, we are committed to expanding our offering of anchors to better protect your workers!

Anchors | Concrete & Steel

UFA30090 | 3/4" Removable Bolt Anchor for Concrete



UFA30080 | Removable Steel Girder Anchor



UFA30301 | Bolt-on steel two hole d-ring anchor

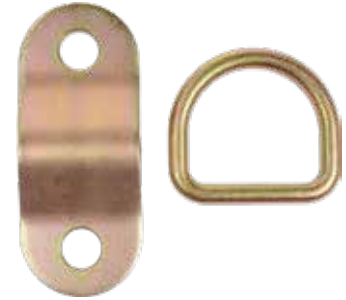

UFA30311 | Bully™ Swivel 10K Anchor for Metal Structure with 5/8", 4" Long Hex Head Bolt, Nut, and Washer



UFA30311(W) | Bully™ Swivel 10K Anchor (without bolt)



UFA30050 | Steel weld-on or bolt-on anchor point



Concrete Embed Anchor Straps

With Loop and D-Ring



Model	Length
UFA20504	4 ft.
UFA20506	6 ft.

With Loops on Both Ends



Model	Length
UFA21004	4 ft.
UFA21006	6 ft.

FR With Loop and D-Ring



Model	Length
UFA20602FR	2 ft.
UFA20603FR	3 ft.
UFA20604FR	4 ft.

ANCHORAGES

Anchors | I-beam

UFA30110 | I-beam anchor, Adjustable to fit flange widths of 3.5" to 14"



UFA30115 | I-beam anchor, Adjustable to fit flange widths of 3.5" to 6"



UFA30130 | Aluminum and Steel Rolling Beam Anchor, adjustable 3.14" - 9.84"



UFA30111 | Column Mount Vertical Beam Anchor, adjustable 3.54" - 13.38"



ANCHORAGES

Multipurpose Anchors | Web Slings

Choker Style Anchor Strap with Wear Pad



Model	Length
UFA20003	3 ft.
UFA20004	4 ft.
UFA20006	6 ft.
UFA20010	10 ft.
UFA20016	16 ft.
UFA20024	24 ft.
UFA20030	30 ft.



Anchors | Wire Cable Slings

Wire Cable Sling, large and small O-rings



Model	Length
UFA710103	3 ft.
UFA710104	4 ft.
UFA710106	6 ft.

Wire Cable Sling with snap hook and large O-ring



Model	Length
UFA710003	3 ft.
UFA710004	4 ft.
UFA710006	6 ft.

Anchors | Drop Thru

UFA30501 | 5K Drop Thru Anchor with Swivel D-ring- 4" Round Plate with 6' Cable
 UFA30501(04) | 5K Drop Thru Anchor with Swivel D-ring- 4" Round Plate with 4' Cable



ROOFER KITS, ANCHORS, GRABS & VLL

Roofing Kits

UFB101025(L-XL) - 25 ft. Rope | **UFB101050(L-XL)** - 50 ft. Rope
Roofers Kit with 5-point Adjustable Harness (size L- XL), 25 ft. or 50 ft. Vertical 5/8" Diameter Polysteel Lifeline with snap hook on anchor and, other end taped, 3 ft. shock absorbing rope grab assembly, reusable hinged roof anchor, storage bucket and lid (ANSI)



UFB201050(L-XL) - Roofers Kit with Elite 5-Point MB Leg Harness Size L-XL, 50 ft. Vertical 5/8" Diameter Polysteel Lifeline with snap hook on anchor and, other end taped, 3 ft. shock absorbing openable non-captive self-tracking rope grab assembly, reusable hinged roof anchor, storage bucket and lid (ANSI)



UFB103050(M-L) - Roofers Kit with Elite 5-Point TB Leg Harness Size M-L, 50 ft. Vertical 5/8" Diameter Polysteel Lifeline with snap hook on anchor and, other end taped, 3 ft. shock absorbing rope grab assembly, reusable hinged roof anchor, storage bucket and lid (ANSI)



UFB102025(M-L) - Roofers Kit with Elite+ 5-Point TB Leg Harness Size M-L, Trauma Relief Straps, 25 ft. Vertical 5/8" Diameter Polysteel Lifeline with snap hook on anchor and, other end taped, 3 ft. shock absorbing rope grab assembly, reusable hinged roof anchor, storage bucket and lid (ANSI)



UFB501125(L-XL) - Roofers Boxed Kit with 3-point Adjustable Harness (size L- XL), 25 ft. Vertical 5/8" Diameter Polysteel Lifeline with snap hook on anchor end, other end folded with heat shrink cover, 3 ft. shock absorbing rope grab assembly, and reusable hinged roof anchor (ANSI).

ROOFER KITS, ANCHORS, GRABS & VLL

Roofing Accessories

Polysteel 5/8" Rope
UFR100025 | 25 ft., **UFR100050** | 50 ft.,
UFR100100 | 100 ft., **UFR100200** | 200 ft.,
UFR100500 | 500 ft.



White Polydac Rope
UFR200025 | 25 ft., **UFR200050** | 50 ft.,
UFR200100 | 100 ft., **UFR200200** | 200 ft.,
UFR200500 | 500 ft.



White Polydac Rope w/ 2 Snap Hooks
UFR210025 | 25 ft., **UFR210050** | 50 ft.,
UFR210100 | 100 ft., **UFR210200** | 200 ft.



UFX903050 | Rope Termination Anchor



UFG602100 | 5/8" Stainless Steel Self-Tracking Rope Grab with Roller Guide



UFG601010 | Anti-panic Self-tracking Rope Grab for 5/8" Rope

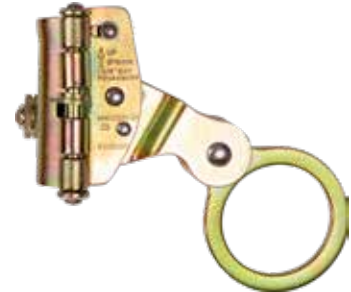

UFG611020 | Manual 3 ft. Shock Absorbing Rope Grab Assembly



UFG611010 | 3' Self tracking non-captive openable shock absorbing rope grab assembly. For use on 5/8" rope.



UFA30015 | Single Use Steel, Raised
UFA30015N | Single Use Steel, Raised w/8 Nails



UFA30020 | Permanent Use Stainless Steel Roof Anchor with D-rings



UFA30001 | Hinged Reusable



UFA30010 | Single Use Steel



UFA30021 | Permanent Use Stainless Steel 17" Roof Anchor with 1 Forged D-ring



ROOFER KITS, ANCHORS, GRABS & VLL

Additional Roof Anchors

Riser Post Roof Anchor for Concrete Decks
UFA55207SW(12) - 12"
UFA55207SW(18) - 18"



End Post for Fixed Systems
UFA55207E(12) - 12"
UFA55207E(18) - 18"

UFA000WT | Wood Truss Anchor / 1,800lbf



UFA30005 | Reusable heavy duty chain roof anchor



UFA30030 | Bull Ring Anchor



UFA30211 | Stand Alone Post for SRL on Standing Trapezoidal Metal Roof Deck; 360° rotation



UFA30201 | Stand Alone Post for SRL on Standing Seam Metal Roof Deck; Seam Widths Ranging from 24" - 36"; 360° rotation



UFA30201S | Steel Swivel Roof Anchor for Self-Retracting Lifeline Used on Standing Seam Metal Roof Deck 16-24"



UFA30070 | Parapet Anchor Clamp with Extended Movable Arm

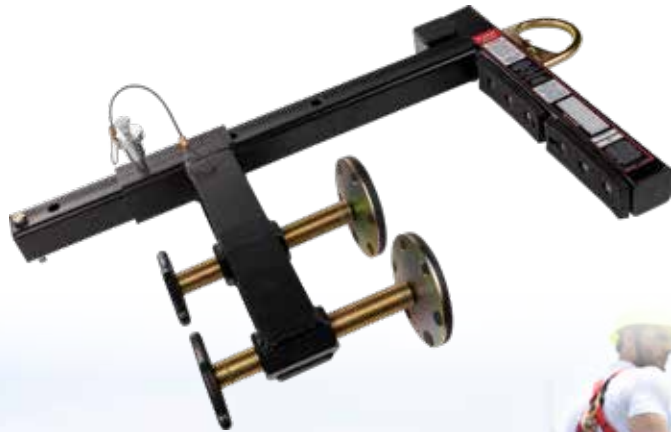

UFA55370 | Single Seam Roof Anchor



ANCHORAGES

Door Jamb/Window Anchor

UFA30401 | Door Jamb/Window Anchor, adjustable 23.6" - 49.2"

- KStrong Door Anchor provides a non-intrusive anchor point and can be easily installed inside the interior of a building or window opening enabling the most difficult jobs to get done safely and with confidence.
- KStrong Door Anchor can be installed by just compressing it against the door or window frame, jamming itself between the two vertical sides.
- It is constructed of Aluminum alloy, hence it is highly corrosion resistant and is lightweight, weighing less than 10.7 lbs.
- The arms of the KStrong Door Anchor are adjustable enabling installation on door/window frames of width from 23.62" to 49.21".
- Fast and easy Installation with built in adjustment knob hence no tools or drilling is required.
- Extremely portable design for easy transport, storage and usage. Every Door Anchor is provided with a deluxe carrying bag.



HORIZONTAL LIFELINES (HLL)



**60 FT.
ADJUSTABLE**
HANDY LINE™
2-PERSON TEMPORARY HORIZONTAL LIFELINE

UFA40110 | KStrong® Handy Line™ 60 ft. Adjustable
2-Person Temporary Horizontal Lifeline System

HORIZONTAL LIFELINES (HLL)

In addition to anchorages, body wear, connectors and devices, KStrong, also provides fall protection solutions for Confined Space Entry, Horizontal Lifeline systems, plus our evolving selection of Dropped Tool Prevention solutions.

Horizontal System

UFA40010 | KStrong® Wrangler™ 100 ft. Adjustable 4-Person Capacity Lightweight Quick Set-up Horizontal Lifeline System. Includes installation carabiner at each end, tension indicator, and two (2) UFA20006 6 ft. anchor straps.

100 FT. ADJUSTABLE **WRANGLER**™ 4-PERSON TEMPORARY HORIZONTAL LIFELINE



Model	Description
UFXR4001	Replacement 100 ft. Replacement Rope Assembly
UFCHLLRING	Replacement Steel O-Ring

UFA40012 | KStrong® Wrangler Jr.™ 60 ft. Adjustable 2-Person Capacity

60 FT. ADJUSTABLE **WRANGLER JR.**™ 2-PERSON TEMPORARY HORIZONTAL LIFELINE



HORIZONTAL LIFELINES (HLL)

Specialty Anchor

UFA30420 - Off-set I-beam stanchion for approved horizontal lifelines

- Anchor post designed to be installed on metal I-Beam
- Can be used as a stand-alone anchor post or to form a horizontal lifeline along the length of I-Beam
- The post comes with a unique tilted design to allow unobstructed movement of the user during the construction of roofs or metal structure
- Span lengths are adjustable with help of intermediates
- Compatible with I-Beam having flange width of 5.9" (150mm) to 8.66" (220mm)



HORIZONTAL LIFELINES (HLL)

Specialty Anchor

Vertical Post for Containers

- Container anchor post is designed to provide a temporary anchor for working on top of 20 ft. - 40 ft. shipping containers.
- In addition to being used as a stand alone anchor post, it can also be used to form a horizontal lifeline over the top of a container depending upon the requirement of work to be done
- Comes with a side lock and tagline arrangement for easy and secure installation that can be performed by one person
- Four holes on the anchor plate (UFA30430) can be used for making connections as anchor points
- Consists of side handle with special grip for easy carrying and safe transportation
- Can be easily removed without damaging the container

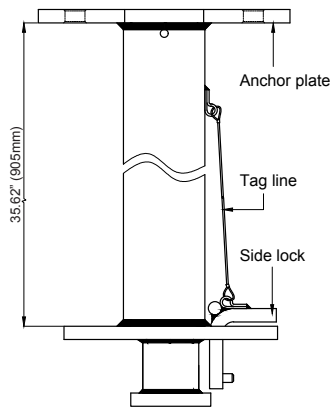
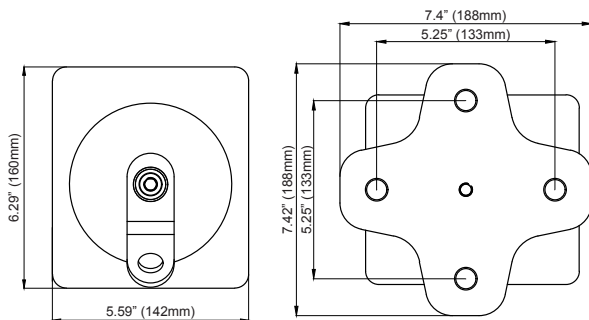

Model	Description
A UFA30430	Four Hole Anchor Plate Top
B UFA30430(SW)	Swivel Anchor Top



ADDITIONAL PRODUCTS

Rescue and Descent - 7 ft. Megapod™ Tripod Kits



**7 ft. Deluxe
Megapod™ Kit**

Model	Description
A UFT510007DK	7 ft. Deluxe Megapod™ Tripod Kit. Includes Tripod, 60 ft. 3-way Rescue Retrieval SRL-R with Mounting Bracket, 60 ft. Material / Personnel Winch, and Storage Bags for Tripod / Equipment.
B UFT510007RK	7 ft. Megapod™ Tripod Recovery Kit. Includes Tripod, 60 ft. 3-way Rescue Retrieval SRL-R with Mounting Bracket, and Storage Bags for Tripod / Equipment.
C UFT510007BK	7 ft. Megapod™ Tripod Basic Kit. Includes Tripod, 60 ft. Material / Personnel Winch, and Storage Bags for Tripod / Winch.



**7 ft. Recovery
Megapod™ Kit**



**7 ft. Basic
Megapod™ Kit**

ADDITIONAL PRODUCTS

Rescue and Descent - 10 ft. Megapod™ Tripod Kits

Model	Description
D UFT510010DK	10 ft. Megapod™ Tripod Deluxe Kit. Includes Tripod, 60 ft. 3-way Rescue Retrieval SRL-R with Mounting Bracket, 60 ft. Material / Personnel Winch, and Storage Bags for Tripod / Equipment.
E UFT510010RK	10 ft. Megapod™ Tripod Recovery Kit. Includes Tripod, 60 ft. 3-way Rescue Retrieval SRL-R with Mounting Bracket, and Storage Bags for Tripod / Equipment.
F UFT510010BK	10 ft. Megapod™ Tripod Basic Kit. Includes Tripod, 60 ft. Material / Personnel Winch, and Storage Bags for Tripod / Winch.



ADDITIONAL PRODUCTS

Rescue and Descent Megapod™ Tripods & Accessories



Dual Built-in Pulley Head Assembly

Model	Description
A	UFT510010 10 ft. Megapod™ Adjustable Height Tripod with Dual Built-in Pulley Head Assembly; Includes Tripod Bag
B	UFT510007 7 ft. Megapod™ Adjustable Height Tripod with Dual Built-in Pulley Head Assembly; Includes Tripod Bag
C	UFT530060 60' Galvanized wire cable Personnel/Material rated bi-directional winch
C	UFT530060(SS) 60' Stainless Steel wire cable Personnel/Material rated bi-directional winch
D	UFT531130 100' Galvanized wire cable Personnel/Material rated bi-directional winch
E	UFS310060R BRUTE™ 60 ft. 3-way SRL-R
F	UFS310090R BRUTE™ 90 ft. 3-way SRL-R
G	UFT510010B Mounting Bracket for 3-way SRL
H	UFT510010B2 Universal Lower Assembly Mounting Bracket Receiver for Winch and 3-Way Rescue/Retrieval Device Brackets
J	UFX903010 Spreader Bar with Snap Hooks (ANSI)
K	UFZ810020 10 ft. Megapod™ Storage Bag
L	UFZ810010 7 ft. Megapod™ Storage Bag
M	TRIP-ASS-031 Replacement Leg Pins for Megapod™
N	MPOD-ASS-005 Megapod™ Chain Link Assembly for 7 ft. Tripod
N	MPOD-ASS-008 Megapod™ Chain Link Assembly for 10 ft. Tripod

ADDITIONAL PRODUCTS

Rescue and Descent Davits



Model	Description
M UFT551080DK	Side Entry Davit Assembly Deluxe Kit with 60 ft. 3-way Rescue Retrieval SRL-R with Mounting Bracket
N UFT551080	Side Entry Davit Assembly with Retrieval Device Bracket (High Strength Aluminum Alloy)

ADDITIONAL PRODUCTS

Rescue and Descent Megadavit™



ADDITIONAL PRODUCTS

Rescue and Descent Megadavit™



Model	Description
A UFT551011DK	Megadavit™ H-Base Deluxe Kit. Includes H-Base Frame Assembly, 54 in. Column Mast, 3 ft. Cantilever Boom Arm with Winch Bracket, 60 ft. 3-way Rescue Retrieval SRL-R with Mounting Bracket, and 60 ft. Material / Personnel Winch
B UFT551011BK	Megadavit™ H-Base Basic Kit. Includes H-Base Frame Assembly, 54 in. Column Mast, and 3 ft. Cantilever Boom Arm with Winch Bracket
C UFT551021DK	Megadavit™ Floor Mount Deluxe Kit. Includes Floor Mount Column Mast Receiver, 54 in. Column Mast, 3 ft. Cantilever Boom Arm with Winch Bracket, 60 ft. 3-way Rescue Retrieval SRL-R with Mounting Bracket, and 60 ft. Material / Personnel Winch
D UFT551021BK	Megadavit™ Floor Mount Basic Kit. Includes Floor Mount Column Mast Receiver, 54 in. Column Mast, and 3 ft. Cantilever Boom Arm with Winch Bracket
E UFT551031DK	Megadavit™ Wall Mount Deluxe Kit. Includes Wall Mount Column Mast Receiver, 54 in. Column Mast, 3 ft. Cantilever Boom Arm with Winch Bracket, 60 ft. 3-way Rescue Retrieval SRL-R with Mounting Bracket, and 60 ft. Material / Personnel Winch
F UFT551031BK	Megadavit™ Wall Mount Basic Kit. Includes Wall Mount Column Mast Receiver, 54 in. Column Mast, and 3 ft. Cantilever Boom Arm with Winch Bracket
G UFT555001	Megadavit™ H-Base Frame Assembly (High Strength Aluminum Alloy)
H UFT556201	Megadavit™ 54 in. Column Mast (High Strength Aluminum Alloy)
J UFT556101	Megadavit™ 36 in. Column Mast (High Strength Aluminum Alloy)
K UFT556001	Megadavit™ 3 ft. Cantilever Boom Arm with Winch Bracket (High Strength Aluminum Alloy)
L UFT555101	Megadavit™ Floor Mount Column Mast Receiver (SS316)
M UFT555201	Megadavit™ Wall Mount Column Mast Receiver (SS316)
N UFT555002	Megadavit™ Concrete Embed Column Mast Receiver (SS316)
O UFT557101	Megadavit™ Hitch Mount with Detent Pin



ADDITIONAL PRODUCTS

EVAC-R+ Rescue System

UFX209070(150) and UFX209070(300) | EVAC-R+ Rescue System

The KStrong® EVAC-R+ Descender, Rescue and Lifting device is an automatic and controlled descent device designed for the lifting or lowering of an injured person.

- Rescue made possible from high level working platforms that require a simple rescue or evacuation solution
- Hand-wheel for lifting of injured and rescuer simultaneously
- A power drill can be easily utilized with the included 10mm Hexagonal head connector to assist in the rescue allowing the injured person to be raised up to the full length of the kit's rope.
- Controlled descent speed: 1m/sec [187 lbs. (85kg)] and 1.5m/sec. [374 lbs. (170kg)].
- Brake system - Automatic, redundant brake system with 2 fly wheel brakes.
- The maximum load of 628 lbs. (285kg) allows simultaneous descending of up to three persons.
- Alternating descending on both rope ends can be carried out to rescue more than three persons efficiently (shuttle system).
- Can be used with Kernmantle Rope \varnothing 11mm, EN 1891-A (EN 341, EN 1496), ANSI Z359.4:2013 & Kernmantle Rope \varnothing 9,6mm till \varnothing 11mm acc. EN 1891-A (EN 12841)C



Model	Description
UFX209070(150)	KStrong® EVAC-R+ Full Rescue Kit with 150 ft. Kernmantle Rope and Hexagon Connector Drill Attachment
UFX209070(300)	KStrong® EVAC-R+ Full Rescue Kit with 300 ft. Kernmantle Rope and Hexagon Connector Drill Attachment
A AFX209070	KStrong® EVAC-R+ Descender, Rescue and Lifting Device
B UFX207001	KStrong® 10 ft. Telescopic Pole for Rescue
C UFC408451	KStrong® Aluminum Rebar Hook for Use with Telescoping Pole
D UFX903051	KStrong® Edge Protector with 6 ft. Wire and ANSI Carabiner
E UFA20006	KStrong® 6 ft. Web Anchor Straps (2 qty)
F UFC401400	KStrong® Quarter Turn Action ANSI Aluminum Carabiner (2 qty)
G AFZ177150	KStrong® EVAC-R+ Rescue Kit Bag for up to 295 ft. (90m)
G AFZ177151	KStrong® EVAC-R+ Rescue Kit Bag for up to 650 ft. (200m)



CONNECTORS

Carabiners

UFC401100 | Steel Carabiner with .84" gate opening



UFC401110 | Small Steel Carabiner with 1" gate opening



UFC408120 | Steel Carabiner with 2" gate opening



UFC408450 | Large Aluminum Rebar Hook with 2" gate opening



UFC401400 | Aluminum Bulb Type Carabiner with .67" gate opening



UFC401101 | Oval Steel Carabiner with .67" gate opening



UFC404450 | Small aluminum quarter turn locking carabiner with swivel load indicator



UFC404500 | Steel Swivel Snap hook with load indicator



UFC404150 | Stamped Steel Snap Hook



UFC405100 | Tie-back snap hook with 5000 lb. rated gate.



UFC408100 | Large rebar hook, stamped - 2.63" opening



DROP PREVENTION

KStrong Kaptor™ tool lanyards are designed to reduce the risk of a dropped tool injuring anyone positioned below a worker. The worker's use of a tool securely attached to a Kaptor™ tool lanyard should significantly reduce the chance of an injury from occurring to workers or others below. Tool lanyards are designed to be attached securely at one end to a worker or to a suitable structure, with the other end attached to common hand tools. KStrong offers a variety of tool lanyards and attachments whose application is determined by the weight of the tool and how the lanyard is attached to a worker or to a structure. Please watch our growing video library for more information.

Kaptor™ Drop Prevention

DL100021 | Locking Single Carabiner - 22 lbs.
ANSI Rated



DL100022 | Dual Leg Locking Single Carabiner
- 22 lbs. ANSI Rated



DA300411 | Wrist Tool Lanyard - 2 lbs.



DA300401 | Pull-On Wrist Lanyard with Buckle
- 3 lbs.



DA300201 | Small Tool/ Radio Holster



DA300301 | Tape Measure Trap



DA300101 | Elastic Hard Hat Lanyard w/ Clamp
- 2 lbs.



DT700101 | Self-Adhering Tape Trap - 12 ft.
Roll



KAPTOR™

DROP PREVENTION



DROP PREVENTION

Kaptor™ Kits

DK400101 | Tool Tethering Kit - 5 lbs. Consists of DL100201 in standard pack of 3, DL100401 in standard pack of 1, DT700101 in standard pack of 1



Tool Tethering Kits (DT700101 and DL100501 plus corresponding Web Tool Tail)

DK400151(S) | Web Tool Tail, 3 lbs. S - 2.5 inches



DK400152(M) | Web Tool Tail, 3 lbs. M - 4.5 inches



DK400153(L) | Web Tool Tail, 3 lbs. L - 5.5 inches



DK400154(XL) | Web Tool Tail, 3 lbs. XL - 6.5 inches



DK400201 | Tape Measure Coil Tethering Kit - 2 lbs. Consists of DL100501 & DA300301 in standard pack



DK400301 | Tape Measure Lanyard Tethering Kit - 2 lbs. Consists of DL100401 & DA300301 in standard pack



DK400155(2XL) | Web Tool Tail, 3 lbs. 2XL - 8.5 inches



DROP PREVENTION

Kaptor™ Tool Lanyards

UDL100012 | Dual Leg - 10 lbs.



DL100021 | Locking Single Carabiner - 22 lbs. ANSI Rated



DL100022 | Dual Leg Locking Single Carabiner - 22 lbs. ANSI Rated



DL100041 | Tool Lanyard Single Carabiner with Web Loop - 22 lbs.



DL100042 | Dual Leg Tool Lanyard Single Carabiner with Web Loops - 22 lbs.



DL100701 | Hook to Loop Bungee Tool Tether - 35 lbs.



DL100711 | Hook 2 Loop Tool Tether, Heavy Duty - 80 lbs.



DL100501 | Coiled Cable Lanyard - 2 lbs.



DL100601 | Clip2Loop Coil Tether, 10 Pack



10-Pack

DL100801 | Wire Loop Tool Tail - 2 lbs. (6-Pack)



6-Pack

DL100802 | Wire Screw Gate Tool Tail - 3 lbs. (6-Pack)



6-Pack

DL100401 | Detachable Elasticated Single Screwgate Carabiner - 5 lbs.



DL100400 | Detachable Elasticated Single Screwgate Carabiner (without Loop) - 5 lbs.



DL100201 | Accessory Kit - Detachable Loops 3-pack



3-Pack

DL100611 | D-Ring with Cord Loop, Attachment Points 10-pack



10-Pack

DROP PREVENTION

Kaptor™ Tool Lanyards

DL100101 | Elastic Loop Tool Tails Ext - 15 lbs. 3-pack



3-Pack

DL100151 | Elastic Loop Tool Tails Swivel - 10 lbs. 3-pack



3-Pack

DL100301 | Web Tool Tails, 3 lbs. 6-Pack S - 2.5 inches



6-Pack

DL100302 | Web Tool Tails, 3 lbs. 6-Pack M - 4.5 inches



6-Pack

DL100303 | Web Tool Tails, 3 lbs. 6-Pack L - 5.5 inches



6-Pack

DL100304 | Web Tool Tails, 3 lbs. 6-Pack XL - 6.5 inches



6-Pack

DL100305 | Web Tool Tails, 3 lbs. 6-Pack 2XL - 8.5 inches



6-Pack

DL100351 | Web Tool Tails with Swivel, 3 lbs. 6-pack S - 2.5 inches



6-Pack

DL100352 | Web Tool Tails with Swivel, 3 lbs. 6-pack M - 4.5 inches



6-Pack

DL100353 | Web Tool Tails with Swivel, 3 lbs. 6-pack L - 5.5 inches



6-Pack

DL100354 | Web Tool Tails with Swivel, 3 lbs. 6-pack XL - 6.5 inches



6-Pack

DL100355 | Web Tool Tails with Swivel, 3 lbs. 6-pack 2XL - 8.5 inches



6-Pack

DL200301 | Tool Cinch, Medium Duty, 35 lbs.



DL200311 | Tool Cinch, Single Wing, Medium Duty, 35 lbs.



DL200101 | Tool Cinch, Dual Wing, Medium Duty, 35 lbs.



DL200201 | Tool Cinch, Dual Wing, Medium Duty, 80 lbs.



ADDITIONAL PRODUCTS

Ladder Climbing System for Fixed Ladders

- Consists of a vertical anchorage line made of stainless steel wire rope installed on a ladder using appropriate mounting brackets.
- Stainless steel rope grab UFG602050 moves along with the user climbing up or down and locks them in case of fall.

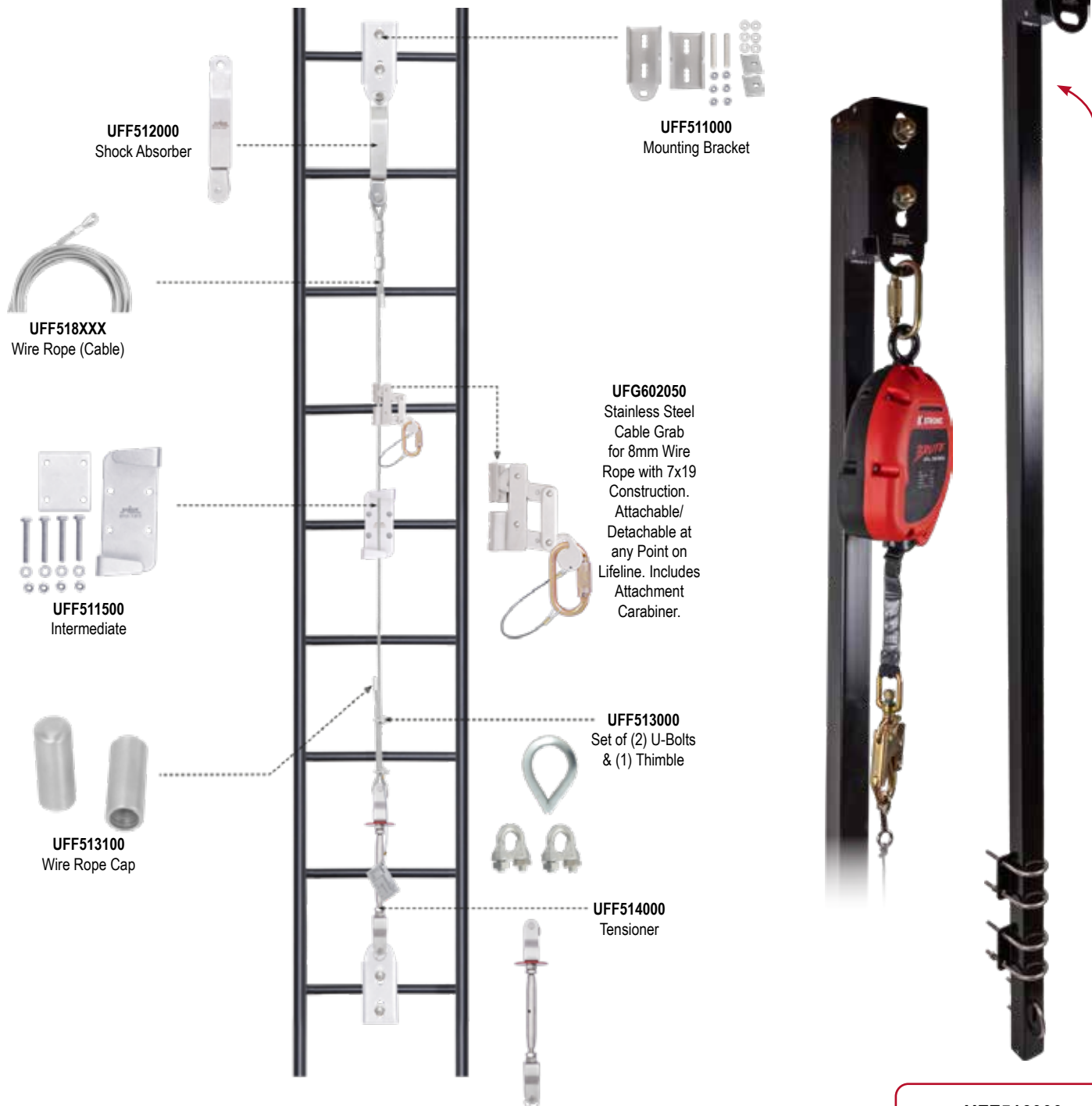

Model	Length	Model	Length	Model	Length	Model	Length
USCLC020	20 ft.	USCLC050	50 ft.	USCLC080	80 ft.	USCLC0130	130 ft.
USCLC030	30 ft.	USCLC060	60 ft.	USCLC090	90 ft.	USCLC0160	160 ft.
USCLC040	40 ft.	USCLC070	70 ft.	USCLC0100	100 ft.	USCLC0200	200 ft.

UFF516000
KStrong® Ladder
Extension Davit Kit for
Fixed Ladders
**(SRL Not Included)*

ADDITIONAL PRODUCTS

Ladder Rescue System

UFZ809030 | 20 ft. Rescue Ladder System

KStrong 20 ft. Rescue Ladder System has been designed for the self-rescue of a conscious user who has had a fall. The ladder kit allows the user to climb to safety with the added benefit of using a backup rope attached to the user which reduces the chance of a secondary fall.

- Rescue ladder kit with 20 ft. ladder and 6 ft. concrete embed strap with loop at both ends
- Equipped with kernmantle rope, rope grab and carabiners
- Simple and easy to deploy Fast Drop System using an existing or a temporary anchor point
- The added rope grab system allows the user to climb efficiently while safely reducing the risk of a secondary fall.
- Optimized for fast and easy rigging
- Only requires one person to operate
- 23 ft. of Rope
- Comes with convenient backpack style bag
- Total kit weight 8.84 lbs.

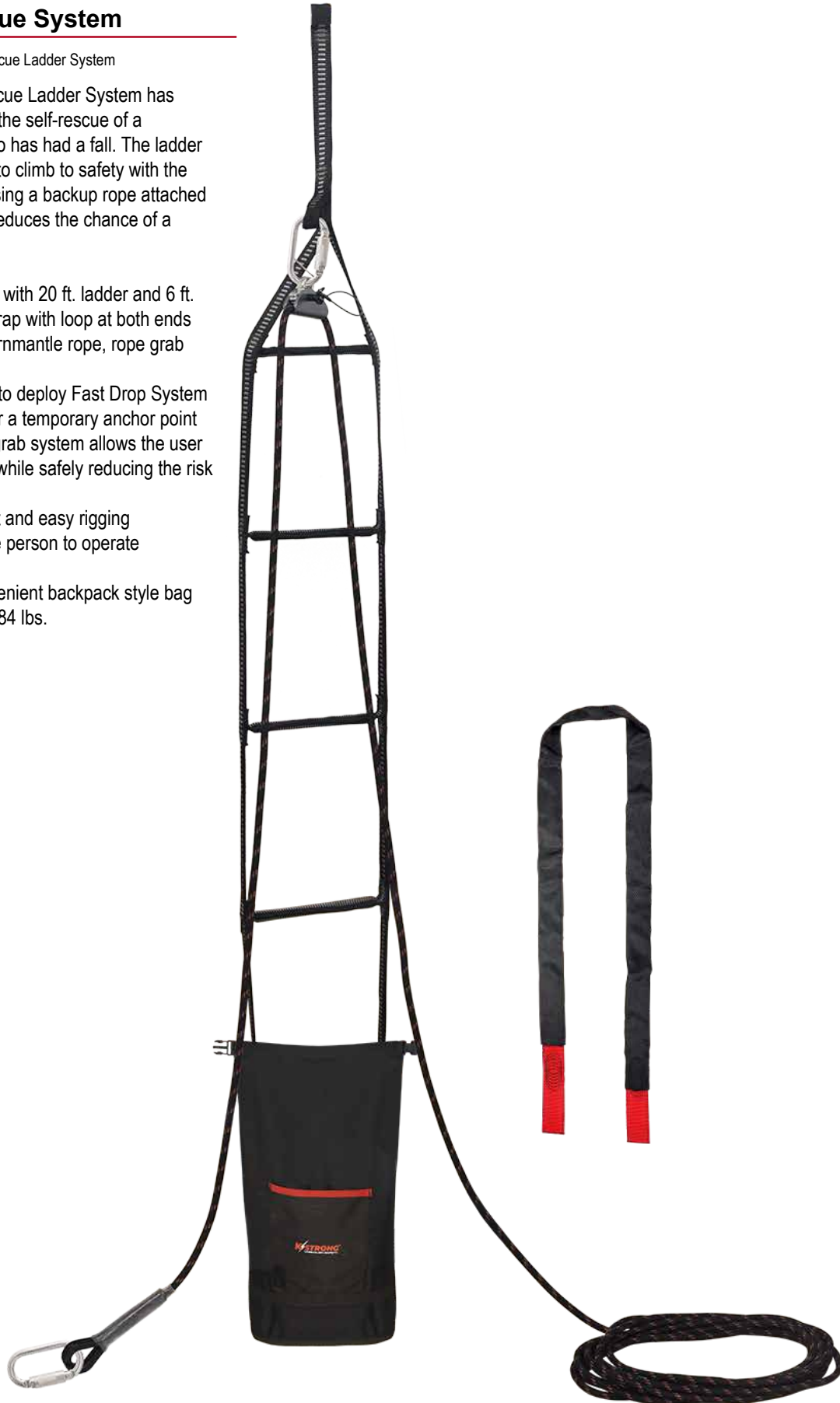

BAGS



Model	Description
A UFZ200101	Kit Bag - Small
B UFBBGF187	All Purpose Durable Equipment Bag (12.5"x16"x24")
C UFBBGKS07	Dry Backpack with Webbing Side and Rope Pocket and an In-Structure Pockets (27"x10"x10"), Red Bottom with Black Top
D UFZ810010	KStrong® 7 ft. Megapod™ Storage Bag
E UFZ810020	KStrong® 10 ft. Megapod™ Storage Bag

QUICK INDEX

Part Number	Page No.	Part Number	Page No.	Part Number	Page No.	Part Number	Page No.	Part Number	Page No.
AFX209070	62	UFA30111	47	UFH10341G	27	UFR200200	50	UFT551011BK	60
AFZ177150	62	UFA30115	47	UFH10700P	28	UFR200500	50	UFT551011DK	60
AFZ177151	62	UFA30130	47	UFH10701P	28	UFR210025	50	UFT551021BK	60
AFZ830025	18	UFA30201	51	UFH10710P	29	UFR210050	50	UFT551021DK	60
AFZ830050	18	UFA30201S	51	UFH10711P	29	UFR210100	50	UFT551031BK	60
AFZ830100	18	UFA30211	51	UFH10731P	29	UFR210200	50	UFT551031DK	60
DA300101	64	UFA30301	46	UFH10732P	29	UFS310010	8	UFT551080	59
DA300201	64	UFA30311	46	UFH10801GQ	27	UFS310018L	12	UFT551080DK	59
DA300301	64	UFA30311(W)	46	UFH10802Q	28	UFS310020	8	UFT555001	61
DA300401	64	UFA30401	52	UFH10811GQ	28	UFS310020(SS)	8	UFT555002	61
DA300411	64	UFA30420	54	UFH152011GQ	26	UFS310025(SS)	8	UFT555101	61
DK400101	65	UFA30430	55	UFH15201GQ	25	UFS310025L	12	UFT555201	61
DK400151(S)	65	UFA30430(SW)	55	UFH15201Q	26	UFS310030	8	UFT5556001	61
DK400152(M)	65	UFA30501	48	UFH15203GQ	25	UFS310050	8	UFT556101	61
DK400153(L)	65	UFA30501(04)	48	UFH15231GQ	26	UFS310050(SS)	8	UFT556201	61
DK400154(XL)	65	UFA40010	53	UFH15231Q	26	UFS310050L	12	UFT557101	61
DK400155(2XL)	65	UFA40012	53	UFH16001GP	22	UFS310060R	58	UFX207001	62
DK400201	65	UFA40110	52	UFH16101G	25	UFS310080L	12	UFX209070(150)	62
DK400301	65	UFA55207E(12)	51	UFH16201GP	21	UFS310090	8	UFX209070(300)	62
DL100021	64, 66	UFA55207E(18)	51	UFH16201GPP(BL)	21	UFS310090R	58	UFX903010	58
DL100022	64, 66	UFA55207SW(12)	51	UFH16231GP	22	UFS310130	9	UFX903050	50
DL100041	66	UFA55207SW(18)	51	UFH19902GQFR	30	UFS310150	9	UFX903051	62
DL100042	66	UFA55370	51	UFH19902PFR	30	UFS310206L	14	UFXR4001	53
DL100101	66	UFA710003	48	UFH19902QFR	30	UFS310206LD	15	UFZ200101	33, 70
DL100151	67	UFA710004	48	UFH19903PQFR	30	UFS314006L	14	UFZ800100	34
DL100201	66	UFA710006	48	UFH90131G	31	UFS314006LD	15	UFZ800200	33
DL100301	67	UFA710103	48	UFH90141G	31	UFS316106L	14	UFZ800501	34
DL100302	67	UFA710104	48	UFH90341G	31	UFS316106LD	15	UFZ801001	33
DL100303	67	UFA710106	48	UFH90471G	31	UFS319006L	14	UFZ801011	33
DL100304	67	UFB101025(L-XL)	49	UFK10010	45	UFS319006LD	14	UFZ801012	33
DL100305	67	UFB101050(L-XL)	49	UFK10015	45	UFS330008	8	UFZ802001	34
DL100351	67	UFB102025(M-L)	49	UFK10025	45	UFS350002	4	UFZ809030	69
DL100352	67	UFB103050(M-L)	49	UFK20010	45	UFS350002D	5	UFZ810010	58, 70
DL100353	67	UFB201050(L-XL)	49	UFK20015	45	UFS350011	10	UFZ810020	58, 70
DL100354	67	UFB501125(L-XL)	49	UFK20025	45	UFS350025	10	UFZ840010	32
DL100355	67	UFBGGF187	70	UFK20410	45	UFS350206L	16	UFZ840020	32
DL100400	66	UFBGGKS07	70	UFK20510	45	UFS350206LD	17	UFZ850100	33
DL100401	66	UFC401100	63	UFK23110	45	UFS351102	4	UFZ910001	32
DL100501	65, 66	UFC401101	63	UFL201101	40	UFS351102D	5	UFZ910005	32
DL100601	66	UFC401110	63	UFL201101(03)	40	UFS354002	4	UFZ920001	32
DL100611	66	UFC401400	63	UFL201101(04)	40	UFS354002D	5	UFZ920011	32
DL100701	66	UFC404150	63	UFL201111	40	UFS354006L	16	USCLC0100	68
DL100711	66	UFC404450	63	UFL201121	40	UFS354006LD	17	USCLC0130	68
DL100801	66	UFC404500	63	UFL201121(04)	40	UFS356002	4	USCLC0160	68
DL100802	66	UFC405100	63	UFL201131	40	UFS356002D	5	USCLC020	68
DL200101	67	UFC408100	63	UFL201301	41	UFS356106L	16	USCLC0200	68
DL200201	67	UFC408120	63	UFL201331	41	UFS356106LD	17	USCLC030	68
DL200301	67	UFC408450	63	UFL201402	41	UFS359002	4	USCLC040	68
DL200311	67	UFC408451	62	UFL201421	40	UFS359002D	5	USCLC050	68
DT700101	64, 65	UFC409151	5	UFL201422	41	UFS359206	11	USCLC060	68
MPOD-ASS-005	58	UFCHLLRING	53	UFL201601	42	UFS359206D	11	USCLC070	68
MPOD-ASS-008	58	UFF511000	68	UFL201611	42	UFS359506	11	USCLC080	68
PN197BA	62	UFF511500	68	UFL201621	42	UFS359506AR	11	USCLC090	68
TRIP-ASS-031	58	UFF512000	68	UFL201622	42	UFS359506D	11	USCLC070	68
UDL100012	65	UFF513002	68	UFL201701	43	UFS359506S	11	USCLC080	68
UFA000WT	51	UFF513100	68	UFL201721	43	UFS390006	6	USCLC090	68
UFA20003	48	UFF514000	68	UFL201740	43	UFS390006D	7		
UFA20004	48	UFF516000	68	UFL201750	43	UFS394006	6		
UFA20006	48	UFG601010	50	UFL204101	38	UFS394006D	7		
UFA20010	48	UFG602050	68	UFL204111	38	UFS396006	6		
UFA20016	48	UFG602100	50	UFL204121	38	UFS396006D	7		
UFA20024	48	UFG611010	50	UFL204131	38	UFS480020	9		
UFA20030	48	UFG611020	50	UFL205201	44	UFS480020L	13		
UFA20504	46	UFH10101G	20	UFL205201(02)	44	UFS480025L	13		
UFA20506	46	UFH10101P	20	UFL205201(03)	44	UFS480030	9		
UFA20602FR	46	UFH10102G	21	UFL205211	44	UFS480050	9		
UFA20603FR	46	UFH10102P	21	UFL205215	44	UFS480050L	13		
UFA20604FR	46	UFH10131G	20	UFL205251	44	UFS5700100	18		
UFA21004	46	UFH10131P	20	UFL205401	44	UFS570030	18		
UFA21006	46	UFH10201G	22	UFL206101	39	UFS570060	18		
UFA30001	50	UFH10201GQ	22	UFL206111	39	UFT510007	58		
UFA30005	51	UFH10201P	22	UFL206121	39	UFT510007BK	56		
UFA30010	50	UFH10211G	24	UFL206131	39	UFT510007DK	56		
UFA30015	50	UFH10211P	24	UFL206214	39	UFT510007RK	56		
UFA30015N	50	UFH10231G	23	UFL206234	39	UFT510010	58		
UFA30020	50	UFH10231P	23	UFL206234	39	UFT510010B	58		
UFA30021	50	UFH10241G	24	UFR100025	50	UFT510010B2	58		
UFA30030	51	UFH10251G	23	UFR100050	50	UFT510010BK	57		
UFA30050	46	UFH10251P	23	UFR100100	50	UFT510010DK	57		
UFA30070	51	UFH10252P	24	UFR100200	50	UFT510010RK	57		
UFA30080	46	UFH10261G	24	UFR200025	50	UFT530060	58		
UFA30090	46	UFH10332G	27	UFR200050	50	UFT530060SS	58		
UFA30110	47	UFH10332P	27	UFR200100	50	UFT531130	58		



THIS. IS. A. GAME CHANGER!

Your KStrong® fall protection gear just got an upgrade like no other.

KStrong Compass™ is a cloud-based software app which relieves the user from a mountain of paper records. The unique AIR system (Automated Inspection Reminder system) reminds a user of a pending competent person inspection that is required to minimize accidents that may happen due to equipment that has not been properly inspected.



Watch Demo Inspection Video
Scan with Camera



Compass™ Features

Introducing KStrong Compass™, the fall protection industry's first "free at your fingertips" mobile application for fall protection equipment asset management.

Pre-Use Inspection Instructions

The mobile app provides each user vital information on inspection and periodic maintenance needs and helps in increasing the life of the equipment.

Get Tech Data & Manuals

User Instruction Manuals, Technical Data Sheets, Declarations of Conformity, Product Images, Videos, PowerPoint presentations and more are available.

Track Usage

The KStrong Compass™ user management system allows equipment to be issued to individuals, thus ensuring accountability towards the upkeep of the equipment.



KStrong Inc.

Address:

150 N. Radnor Chester Road Suite F200
Radnor, Pennsylvania 19087

Email: contact@kstrong.com

Hours of Operation:

8am - 8pm EST

Phone/Fax:

1-833-KSTRONG

Website:

www.KStrong.com

Proud Members of:



AMERICAN SOCIETY OF SAFETY PROFESSIONALS



Last Revision Date: August 22, 2024