

KStrong® BRUTE™ Sealed 30 ft. SRL with stainless steel cable and stainless steel swivel snap hook. Includes stainless steel installation carabiner and tagline (ANSI).

Model: UFS570030

BRUTE™

SEALED SERIES

30' Sealed Housing SRL with stainless steel cable and stainless steel load indicator swivel snap hook. Includes stainless steel installation carabiner and tagline.

DESIGN

- Sealed design to restrict entry of dust, chemicals, fumes or any liquids inside to protect critical internal parts from contamination in off shore and areas where chemical hazard is evident
- Robust & durable polymer casing around metal chassis
- D-shackle at anchorage point for making connections
- Swivel stainless steel snap hook with load indicator at attachment end
- Stainless steel wire rope

CABLE

Material: Stainless steel wire rope Ø3/16"
Minimum Breaking Strength: 3800 lbs.

LENGTH

30 Feet

WEIGHT

16.53 lbs. ± 0.22 lbs. (7498 gm ±100 gm)

RELEVANT STANDARDS

Meets or Exceeds ANSI Z359.14-2014 Class B & IP 68 Level of IEC 60539



FRONT VIEW

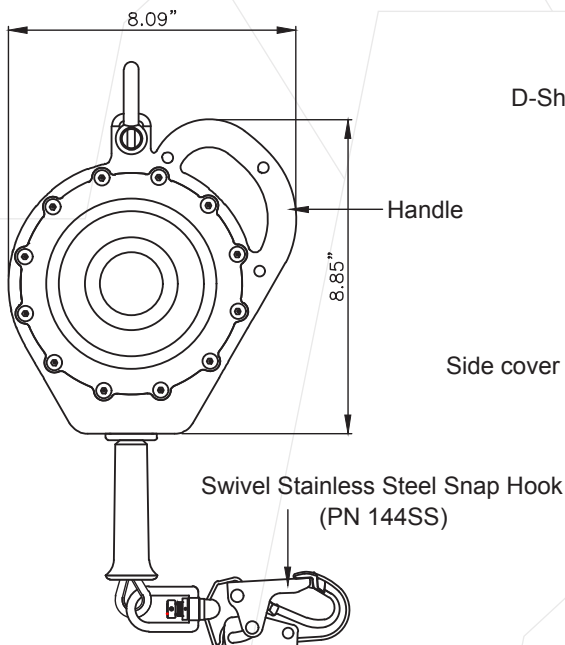

SIDE VIEW

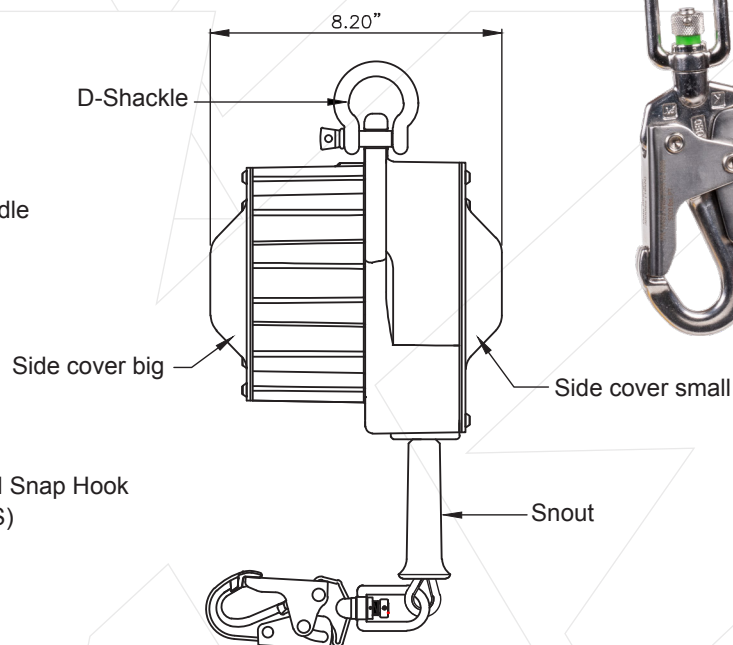

Batch #: _____ Serial #: _____
Date of First Use: _____