

KStrong® Kaptor™ Webbing Tool Connector M - 115mm, 1.36kg

Model: DL100352

KAPTOR™
TOOL LANYARDS

DESIGN

- Medium tool attachment made in 15mm polyester webbing with swivel at one end and folded end at other end
- Provided with a lightweight swivel

MATERIAL

Webbing - 15mm Polyester.
Swivel - Alloy Steel

CAPACITY

1.36kg

LENGTH

115mm

WEIGHT

16 gm ± 1 gm

RELEVANT STANDARDS

Meets or Exceeds ANSI/ISEA 121-2018

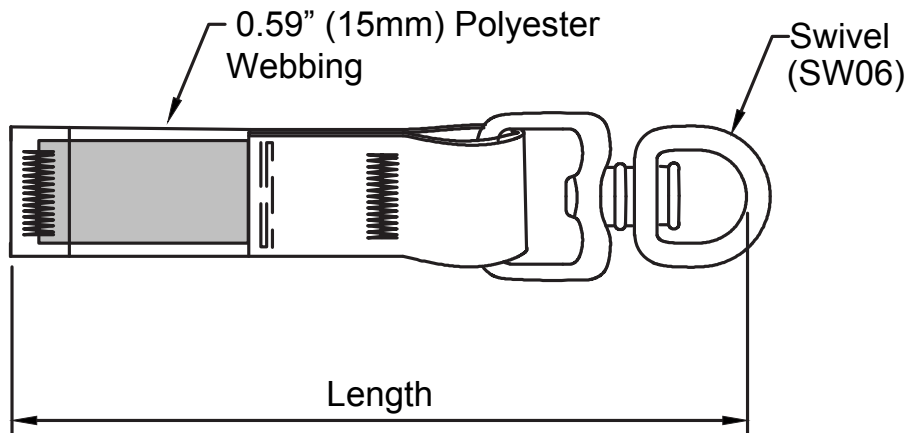

Length- 4.5" (114mm)

Meets or Exceeds ANSI/ISEA 121-2018