

IRSQ 360 DEGREE ALUMINUM SWIVEL

AFX200631

Features

- The Aluminum Swivel is designed to prevent twisting and tangling when the load is turning during handling.
- Sealed Ball bearing for reliability and performance.
- 360 deg Rotating swivel is suitable for mountaineering, climbing, descending, expanding, firefighting and , rescue.
- Simple attach two Karabiner at each end.
- Light and compact.

How To Use

Refer to User Instruction Manual



Metal Components

Material	:	7075 T6 Aluminum Alloy
Finish	:	Natural Silver / Colored Anodized
Minimum Breaking Strength	:	23 kN

Weight

135 gm ± 4 gm

Relevant Standards

Certified to PPE-R/11.135 version 3 (EN12275:2013 Static Strength and EN 354:2010 Corrosion resistance)

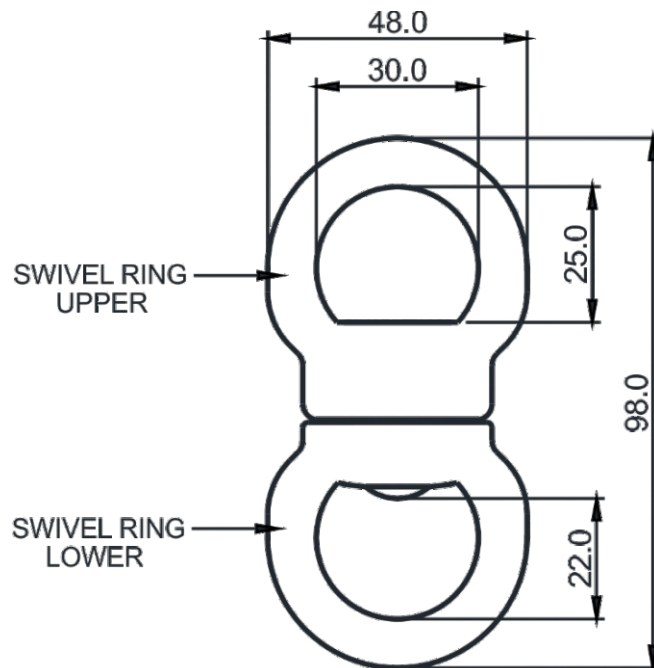

CE 0598