



IMPACT

—LIFELINE SERIES—

AFF4000
IMPACT SERIES
HORIZONTAL
LIFELINES

USER INSTRUCTION MANUAL
&
TECHNICAL INFORMATION



MUST BE READ AND UNDERSTOOD PRIOR TO INSTALLATION



Disclaimer

The information provided in this User Instruction is based on the technical data that KStrong obtained under laboratory conditions and believes to be reliable. KStrong does not guarantee results and takes no liability or obligation in connection with this information. Since conditions of end-use are beyond our control, it is the user's responsibility to determine the hazard levels and the use of proper personal protective equipment. Persons having technical expertise should undertake evaluation under their specific end-use conditions, at their discretion and risk. Please ensure that this information is only to check that the product selected is suitable for the intended use. Any product that is damaged, torn, worn, or punctured should be discontinued from usage immediately.

CONTENTS

Know Your System	01
Standards	02
Instruction Guide	03
Receiving Structure	06
IMPACT FALL ARREST SYSTEM COMPONENTS	06
Trapezoidal	06
Standing Seam	07
Kliplok	08
COMPONENT CHART	09
Shock Absorber	10
Tensioner	11
Wire Rope	12
Carriage Body	13
Cable Termination	14
Extremity Anchor Posts	15
Intermediate Posts	16
Corner Posts	17
Variable Corner Bend Posts	18
Inspection Plate: AFF115101H	19
INSTALLATION	20
General	20
Trapezoidal Post Assembly	20
Installation of Trapezoidal Posts	21
Standing Seam Post Assembly	23
Installation of Standing Seam Posts	24
Kliplok Post Assembly	25
Installation of Kliplok Posts	26
Installation of the System	27
PRE- USE CHECKS & PRECAUTIONS	31
Post Installation Inspection	31
Precautions While Using the System	32
INSPECTION USE AND MAINTENANCE	33
PPE Inspection and Revalidation	33
Warranty	34
Tools Required	35
Proof Loading	37
Inspection Log	38

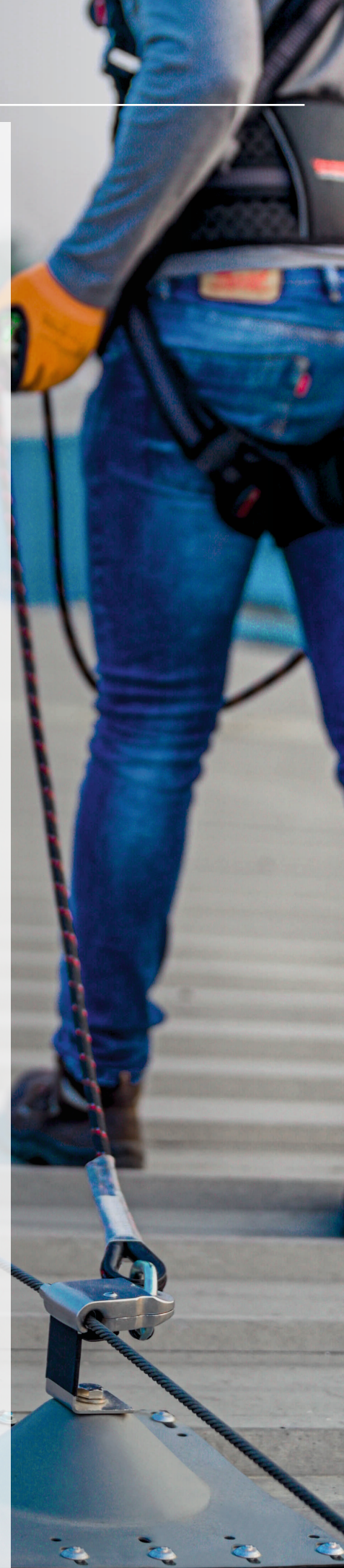

Know Your System

AFF4000 IMPACT LIFELINE SERIES

The Horizontal Lifeline provides permanent anchorage to a user who has to constantly move along an elevated horizontal track. It comprises of 8mm 7x19 stainless steel wire rope grade 316 running all along the horizontal track, installed on the shock absorbing eye of the impact post. The intermediate brackets hold the wire in position all along the length and are installed at intervals between 5 to 15 meters. The line is maintained in tension with the help of a tensioner at one end, while the other end has a swagged or swageless termination fixed on to the shock absorbing eye of the extremity post.

The stainless steel Traveler connects the user to the horizontal life line with the help of a lanyard, rope grab fall arrestor or a retractable lanyard (Micron) and moves smoothly without interruption along the entire length of the horizontal line and also through the intermediate brackets, thus ensuring 100% anchorage of the user at all times.

The line has a shock absorber at one end which reduces the impact of fall on the user as well as on the roof sheets. Additionally the extremity posts, intermediate posts and corner posts are provided with additional shock absorption elements to absorb the fall arrest forces and protect the roof sheets from damage.









Using waterproof rivets and self drilling screws (to attach directly to the purlins) the roof posts are installed on trapezoidal roof. Aluminum seam clamps allows the roof posts to be installed on standing seam or kliplok sheets.

AFF4000 Impact Lifeline Series conforms to EN795:2012 Type C and TS 16415:2013 and can be used by up to four users simultaneously. It has the unique distinction of being certified by Sira for ATEX to comply with use in potentially explosive atmosphere (as per Potentially Explosive Atmospheres Directive 94/9/EC) and conforms to Norms EN 13463-1: 2009 and EN 13463-5: 2003. The system is certified to be intrinsically safe, hence is an ideal choice for use in Industries like Petroleum/ Petro-Chemical Plants without fear of causing explosion due to any spark.

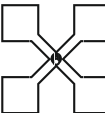
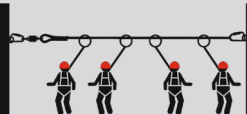

HORIZONTAL ANCHORAGE LINE SYSTEM

Standards

Standards		Description
EN 353-1		Guided type fall arresters including a rigid anchor line
EN 353-2		Guided type fall arresters including a flexible anchor line
EN 795 Type A		Anchor device requiring the fixing of one or more structural anchors
EN 795 Type B		Anchor device not requiring the fixing of one or more structural anchors
EN 795 Type C		Anchor devices using a horizontal flexible anchor line
EN 795 Type D		Anchor devices using a horizontal rigid anchor line
EN 795 Type E		Deadweight anchoring device
CEN/TS 16415:2013		Personal fall protection equipment - Anchor devices - recommendations for anchor devices for use by more than one person simultaneously
 II 2G Ex h IIc T6 Gb EN 80079-36:2016 EN 80079-37:2016		The ATEX directives are two EU directives describing the minimum safety requirements for workplaces and equipment used in explosive atmospheres

Must be Read Prior to Use

- Prior to use, ensure all operating procedures have been read and properly understood.
- This fall arrest system is only to be used by competent persons who have experience and training in the safe use of the system and associated equipment.
- Ensure all local workplace OH&S requirements are identified and understood.
- A risk assessment with a safe work method procedure must be completed and approved by management prior to work commencing.
- The system requires periodic inspection and maintenance by the manufacturer or their authorized representative as per EN365 of the PPE Regulation 2016.
- The system **MUST NOT** be used if the service date is overdue.
- A rescue plan must be formulated and ready for implementation prior to using any fall arrest system.
- Authorisation to access any risk area must be obtained from the person in control of the workplace.
- Only approved full body harness, lanyard and PPE certified either EN, ANSI or AS/NZS Standards are to be used with this system.
- Visually inspect the system for damage prior to use. The system must not be used if there is any deterioration or deformation of components or the structure to which the system is attached.
- If the safety system is damaged or has arrested a fall, discontinue use until it has been fully inspected and recertified by the manufacturer or their authorized representative.
- Ensure all fixings, fittings and components are securely attached. Any tightening, adjustment or replacement of components must be carried out by a competent person.
- Users must not be allowed to work alone in fall arrest situations in case emergency rescue assistance or first aid is required.
- All applicable EN Standards, Local OHS Acts & Regulations, and Codes of Practice & Guidelines must be read and obeyed when using this safety system.

Instructions for Periodic Examinations

- As per EN 365 of PPE Regulation 2016, it is necessary to carry out regular periodic examinations. The safety of the users depends upon the continued efficiency and durability of the equipment.
- The personal protective equipment shall be examined at least every 12 months.
- For corrosive/harsh environments, every 6 months. (more frequent inspection may be required).
- The periodic examination can only be carried out by the manufacturer or their authorized representative.
- The comments should be included in the check card of the equipment. After the periodic examination, the next due date for periodic examination will be determined.
- During periodic inspection, it is necessary to check the legibility of the equipment marking.
- To check metals for sharp edge, burs, corrosion, bent profile distortion and opening & closing or such mechanisms for which that is intended for.

Remove from Service

- In case that it has been used to arrest a fall, the equipment must be withdrawn from use.
- Labels have been removed, are missing or illegible
- Excessive abrasive wear has occurred
- Broken fibres, tears, cuts, snags and splinters are present
- Deterioration or stretching has occurred
- Parts and mechanisms are not moving freely or are corroded
- There is excessive contamination not removed by approved cleaning methods

HORIZONTAL ANCHORAGE LINE SYSTEM

Job Safety Analysis

Before commencing the job, it is recommended that the service technician / installer completes a JSA form, to identify hazards at site and to decide the correct PPE they need to mitigate the hazard. Refer to the example below.

Section 1 Job details					
JSA title	Project name		Work order or PID No.		
	Principal contractor				
Location / address				Date/s of activity	
Prepared by		Date prepared		Signature	

Permits required				Isolations required	
<input type="checkbox"/> Confined Space	<input type="checkbox"/> High risk work rescue plan	<input type="checkbox"/> High voltage access	<input type="checkbox"/> Roof Access	<input type="checkbox"/> Mechanical	<input type="checkbox"/> Hydraulic
<input type="checkbox"/> Work at height	<input type="checkbox"/> Excavation and trenching	<input type="checkbox"/> Energized work	<input type="checkbox"/> Other (please specify)	<input type="checkbox"/> Electrical	<input type="checkbox"/> Pneumatic
<input type="checkbox"/> Penetrating	<input type="checkbox"/> Grid mesh, flooring and guard rail removal	<input type="checkbox"/> Hot work		Site access required	<input type="checkbox"/> YES <input type="checkbox"/> NO

Section 2-Common hazards (Each Hazard identified below must be assessed)

Chemicals/hazardous substances		High-risk activities	
Name of chemicals or hazardous substance <input type="checkbox"/> SDS available		<input type="checkbox"/> Confined space	<input type="checkbox"/> Work at heights
		<input type="checkbox"/> Hot Work	<input type="checkbox"/> Excavation, trenching or penetrations
Energy sources		<input type="checkbox"/> Construction work	<input type="checkbox"/> Scaffolding
<input type="checkbox"/> Electricity	<input type="checkbox"/> Pressure	<input type="checkbox"/> Demolition	<input type="checkbox"/> Structural alterations
<input type="checkbox"/> Gas / Fuel	<input type="checkbox"/> Water	Work location	
Plant and equipment		<input type="checkbox"/> Sun	<input type="checkbox"/> Working over, in or near water
<input type="checkbox"/> Fixed Plant	<input type="checkbox"/> Mobile Plant	<input type="checkbox"/> Plants, Animals or Insects	<input type="checkbox"/> Contaminated / Flammable atmosphere
<input type="checkbox"/> Vehicles / boats	<input type="checkbox"/> Hand Tools	<input type="checkbox"/> Slips, trips and falls	<input type="checkbox"/> Work occurring in other areas
Manual tasks		<input type="checkbox"/> Biological hazards	<input type="checkbox"/> Fire
<input type="checkbox"/> Repetitive tasks	<input type="checkbox"/> Heavy Lifting	People	
<input type="checkbox"/> Awkward posture	<input type="checkbox"/> Sustained posture	<input type="checkbox"/> Remote or isolated work	<input type="checkbox"/> Contractors
Facilities / built environment		<input type="checkbox"/> Fatigue	<input type="checkbox"/> Visitors / land owners / public
<input type="checkbox"/> Buildings and fixtures	<input type="checkbox"/> On/in or adjacent to roadways	<input type="checkbox"/> Competency or training required	<input type="checkbox"/> License required
<input type="checkbox"/> Open pits, trenches or tunnels	<input type="checkbox"/> Asbestos/ lead	Environment and water quality	
<input type="checkbox"/> Overhead objects or services	<input type="checkbox"/> Underground objects or services	<input type="checkbox"/> Erosion & sediment control	<input type="checkbox"/> Waste/ discharge
<input type="checkbox"/> Lighting	<input type="checkbox"/> Noise	<input type="checkbox"/> Emissions (or air pollution)	<input type="checkbox"/> Flora/ fauna/ weed management
<input type="checkbox"/> On or near pressurized gas distribution mains or piping	<input type="checkbox"/> On or near chemical. fuel or refrigerant lines	<input type="checkbox"/> Release to drains/waterways	<input type="checkbox"/> Water quality

HORIZONTAL ANCHORAGE LINE SYSTEM

Receiving Structure

You need to ensure that the strength of the receiving structure is greater than the forces generated in the system. If in doubt, please consult your engineer.

The engineered lifeline has been designed by trained engineers and installers of KStrong using state-of-the-art Compass software. The lifeline is equipped with advanced shock absorption system which reduces the impact and forces on the receiving structure.

The information on structure strength shall be provided by the client. In case the strength of the receiving structure is not known or If in doubt, it is important to get the load calculation done from a competent authority or a certified structural engineer. The Impact Posts are suitable for a variety of roof sheet profiles with a minimum thickness of 0.40mm for steel and 0.70mm for aluminum. KStrong does not take responsibility for malfunction due to inadequacy in the receiving structure.

If the strength of the structure is less than 12kN, (such as aluminum roofing sheets, concrete, or brick walls), then the Compass software allows the engineer to compute an optimum bill of material (BOM), based on the structure's strength.

Please ensure that the entire system is compatible with the other personal fall protection equipment used, and is in conformance with those recommended for use by KStrong. No change may be done in the life line system without a prior confirmation by KStrong authorized personnel.

Third party installations by uncertified installers are not recommended for these products. In case of third-party installations, KStrong will not be held responsible for any failure of the product in its intended use.

IMPACT Fall Arrest System Components

Trapezoidal Roof Profiles

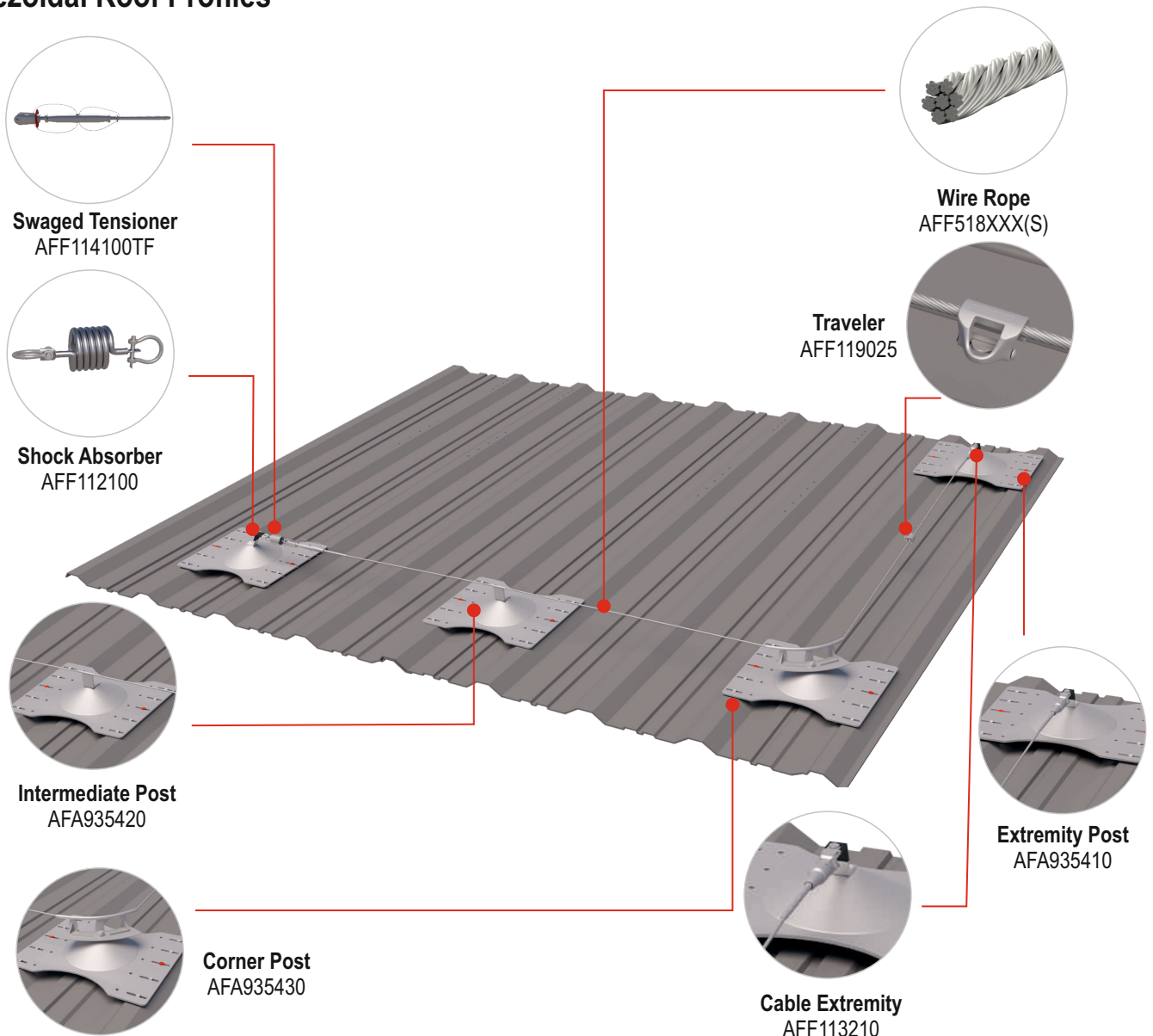

HORIZONTAL ANCHORAGE LINE SYSTEM

Standing Seam Roof Profiles

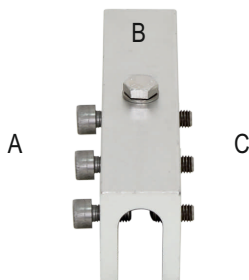
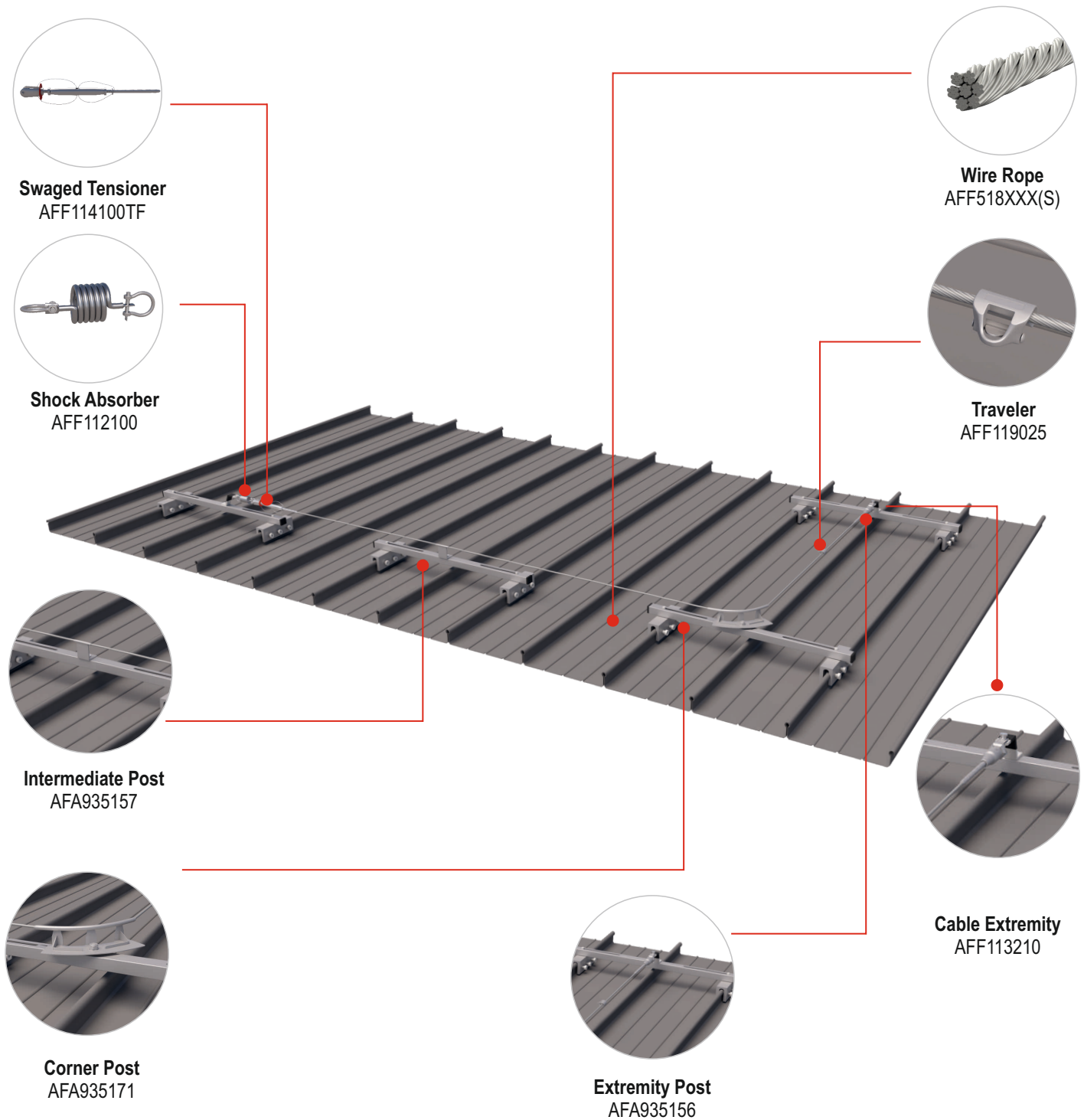

STANDING SEAM FASTENERS / CONNECTOR

Type	A) Hex Bolt	B) Hex Bolt	C) Grub Screw
Size(mm)	10X25	10X25	12X25
Qty	3	1	3
Torque	15 Nm	17 Nm	17 Nm

Clamp Suitable for 18mm to 23.0mm wide standing seam bulb size profile.

HORIZONTAL ANCHORAGE LINE SYSTEM

Kliplok Roof Profiles

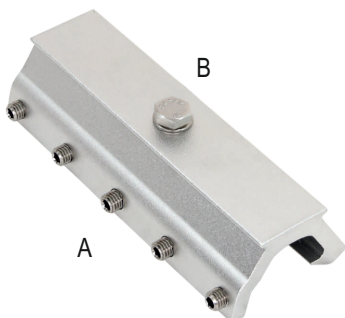
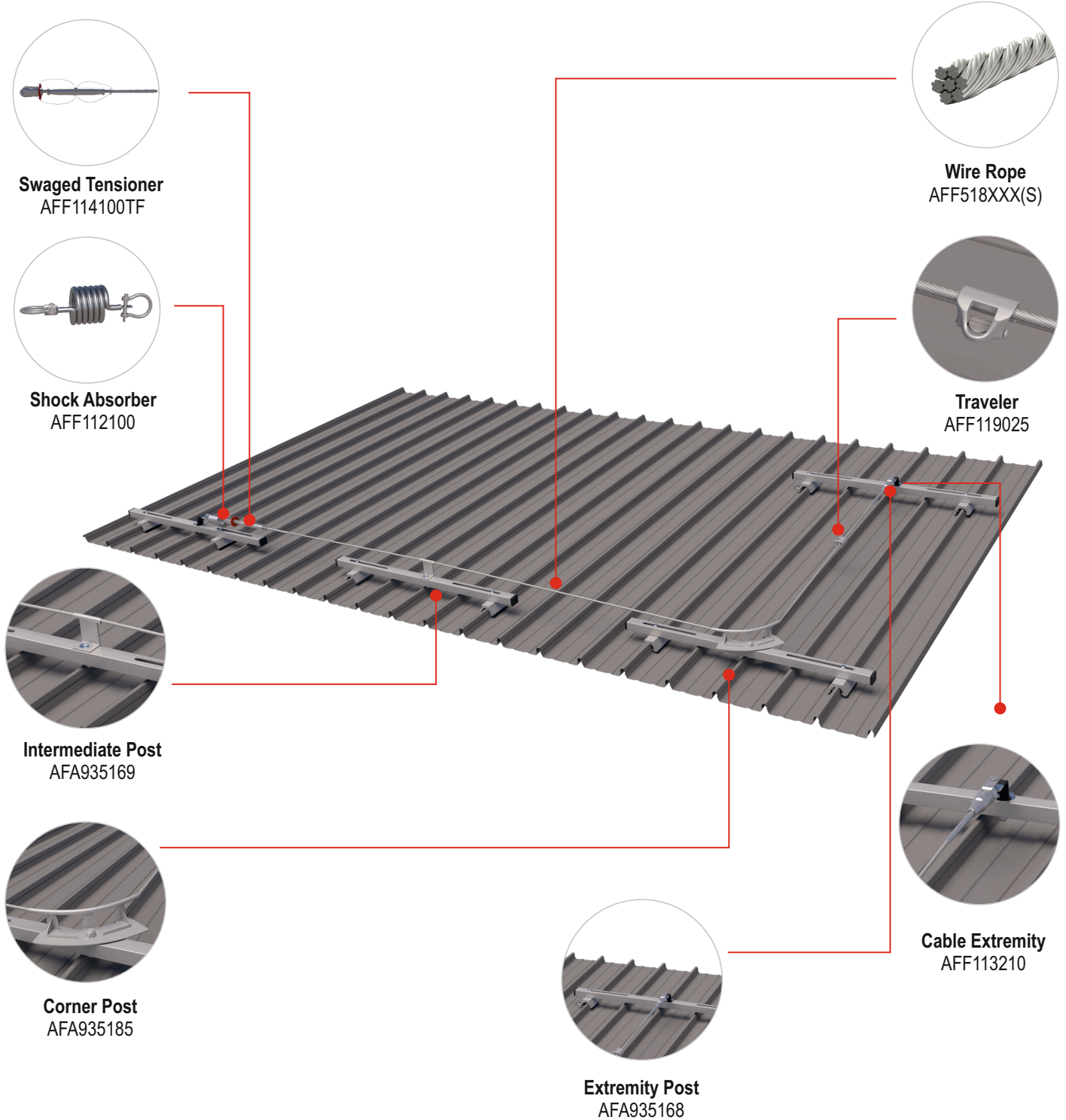

KLIPIKOK FASTENERS / CONNECTOR

Type	A) Grub Screw	B) Hex Bolt
Size(mm)	10X25	12X25
Qty	5	1
Torque	15 Nm	17 Nm

Kliplok Clamps to suit different Kliplok Roof Profiles:
 AFA935176 - KLIPIKOK 770
 AFA935174 - KLIPIKOK 406
 AFA935178 - KLIPIKOK 700

HORIZONTAL ANCHORAGE LINE SYSTEM

Component Chart

The chart below shows all the components of the Horizontal Lifeline Systems with their appropriate product codes and quantity required in a system. Depending on the receiving structure, the user may select appropriate posts. The quantity of the posts depends upon the length of life line, number of corners and the distance between two spans. The span distance may be between 5 to 15 meters.

TECHNICAL SNAPSHOT				
Sr. No.	Component	Code	Qty. Required	
1	Shock Absorber	AFF112100	1 no.	
2	Tensioner	AFF114100TF	1 no.	
3	Wire Rope	AFF518XXX(S)	As per length	
4	Traveler	AFF119000	As per no. of users	
5	Cable Extremity	AFF113210	1 no.	
6	Inspection Plate	AFF115101	1 no.	
	Roof Posts	Trapezoidal	Standing Seam	KlipLok
7	Extremity Posts	AFA935410	AFA935156	AFA935168
8	Intermediate Posts	AFA935420	AFA935157	AFA935169
9	Corner Posts (60,90,120 Degrees)	AFA935430	AFA935171	AFA935185
10	Variable Corner Bend	AFA935430(CB)	AFA935171(CB)	AFA935185(CB)

Recommended PPE

While working on a roof, the user can select from a range of PPE to work safely with either lanyards, rope lines or SRL's in conjunction with a full body harness.



Energy Absorbing
Webbing Lanyard
AFL408131



Work Positioning
Lanyard with Grip
Adjuster
AFL405111



Rope Line with
Shock Absorber
AFA951201



2m Micron SRL
AFS550002



Full Body Roofers Harness
AFH300203

Shock Absorber

The Shock Absorber reduces the impact of the fall on the user as well as on the structure. The shock absorber also has a tension indicator at one end to help the installer know how much tension is to be given to the line after the installation.



TECHNICAL SNAPSHOT

Shock Absorber	AFF112100
Design	Multiple User
Application	Spring type shock absorber. It reduces the impact force in the event of a fall or overloading on the system.
Minimum Activation Force	1kN
Length	258 mm
Material	Shock Absorber 316 Stainless Steel D-Shackle 316 Stainless Steel
MBS	25 kN
Weight	1.5 kgs
Operating Temperature	-40°C to +60°C
Inspection Frequency	Annual
Conforms to	EN 795:2012 Type C and TS16415 & AS/NZS 5532:2013

HORIZONTAL ANCHORAGE LINE SYSTEM

Tensioner (c/w Tension Force Indicator)

The Tensioner is attached to the shock absorber using stainless steel nut bolts and has a swageless termination at one end for the wire rope. Once the life line is installed, the tensioner is tightened by inserting a rod in the hole and rotating it. Comes with a tension force indicator plate which starts rotating once the adequate amount of tension has been achieved in lifeline.

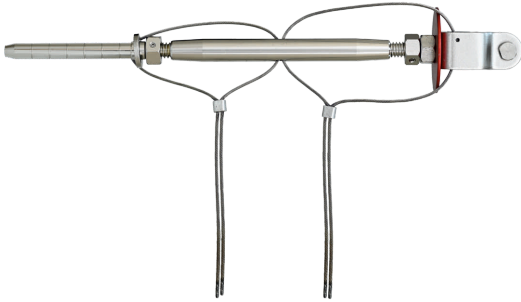

TENSIONER WITH SWAGING

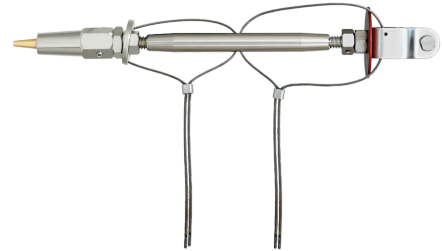

SWAGELESS TENSIONER

TECHNICAL SNAPSHOT

Tensioner	AFF114100TF	AFF114100(SL)
Design	It has one side swage and one side eye to fix in the shock absorber	It has one side swage less extremity and one side eye to fix in the shock absorber
Application	The tension device is an interconnection between the cable and shock absorber with cable length adjustment feature.	The tension device is an interconnection between the cable and shock absorber with cable length adjustment feature.
Size	14 mm	14 mm
Material	Stainless Steel Grade 316	Stainless Steel Grade 316
Weight	1.0 kg	1.0 kg
Operating Temperature	-40°C to +60°C	-40°C to +60°C
Inspection Frequency	Annual	Annual
Minimum Breaking Strength	35 kN	35 kN
Conforms to	EN 795:2012 Type C and TS16415 & AS/NZS 5532:2013	EN 795:2012 Type C and TS16415 & AS/NZS 5532:2013

HORIZONTAL ANCHORAGE LINE SYSTEM

Wire Rope

Stainless Steel Cable



WIRE

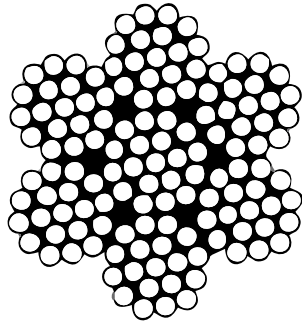

7 STRANDS
OF 19 WIRES

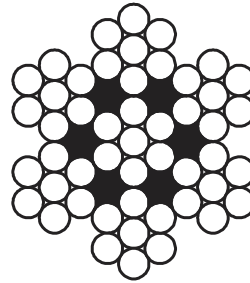

7 STRANDS
OF 7 WIRES

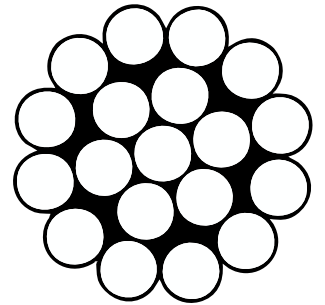

1 STRANDS
OF 19 WIRES

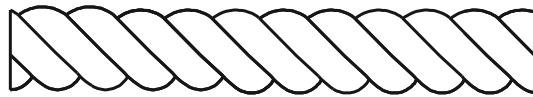

8MM WIRE CABLE

TECHNICAL SNAPSHOT

Wire Rope	AFF518XXX(S)	AFF5187X7XXS	AFF518119XXS
Design	7X19	7X7	1X19
Application	Stainless steel cable for horizontal and vertical life line system	Stainless steel cable for horizontal and vertical life line system	Stainless steel cable for horizontal and vertical life line system
Size	8 mm	8 mm	8 mm
Material	Stainless Steel Grade 316	Stainless Steel Grade 316	Stainless Steel Grade 316
MBS	39 kN	39 kN	44 kN
Weight	0.24 kg per meter	0.30 kg per meter	0.34 kg per meter
Operating Temperature	-40°C to +60°C	-40°C to +60°C	-40°C to +60°C
Inspection Frequency	Annual	Annual	Annual
Conforms to	EN 795:2012 Type C and TS16415 & AS/NZS 5532:2013	EN 795:2012 Type C and TS16415 & AS/NZS 5532:2013	EN 795:2012 Type C and TS16415 & AS/NZS 5532:2013

HORIZONTAL ANCHORAGE LINE SYSTEM

Traveler

Simply connect a karabiner to the traveler when using a lanyard, rope line or a fall arrestor with a full body harness allowing the user to freely travel along the length of the line.

The traveler may be attached or detached from the line at any given point by two consecutive deliberate actions. In applications on roofs, the carriage body may be used on either side of the roof.



TECHNICAL SNAPSHOT

Traveler	AFF119025	AFF119000
Design	Openable Traveler with Karabiner suitable for all horizontal systems with corners with multiple spans	Openable Traveler suitable to be used on 7x19, 7x7 and 1x19 - 8 mm stainless steel wire cable
Application	The stainless steel Travelers connects the user to the line with the help of lanyard / retractable block and moves smoothly without interruption along the entire length of the horizontal line	The stainless steel Travelers connects the user to the line with the help of lanyard / retractable block and moves smoothly without interruption along the entire length of the horizontal line
Material of Construction (MOC)	Traveler: Stainless Steel Grade 316 Karabiner: Stainless Steel Grade 316	Stainless Steel Grade 316
Weight of Component (WOC)	0.212 gms + 0.198 gms	0.7 kg
Operating Temperature	-40°C to +60°C	-40°C to +60°C
Recommended Inspection Frequency	Annual	Annual
Minimum Breaking Strength	25 kN	25 kN
Conforms to	EN 795:2012 Type C and TS16415 & AS/NZS 5532:2013	EN 795:2012 Type C and TS16415 & AS/NZS 5532:2013

HORIZONTAL ANCHORAGE LINE SYSTEM

Cable Termination

The Stainless Steel Cable Extremity attaches directly to the end of the 8mm wire rope allowing a simple and easy connection to the extremity anchor. Simple and easy to install on the desired length of the cable. The extremity provides neat end connection eliminating any loose wires.



CABLE EXTREMITY SWAGELESS



SWAGED

TECHNICAL SNAPSHOT

Cable Termination	AFF512001	AFF113210
Design	Swageless	Swaged
Application	Cable extremity provides strong swageless end connections to the wire rope and completely eliminate the danger of any loose wire which may cause injury to the user working on the line.	The swage provides a strong end connection. The swaging is done using a 130kN hydraulic swaging hand tool and hexlock dies at 6 positions.
Material of Construction (MOC)	Stainless Steel Grade 316	Stainless Steel Grade 316
Weight of Component (WOC)	0.4 kg	0.5 kg
Operating Temperature	-40°C to +60°C	-40°C to +60°C
Inspection Frequency	Annual	Annual
Minimum Breaking Strength	25 kN	25 kN
Conforms to	EN 795:2012 Type C and TS16415 & AS/NZS 5532:2013	EN 795:2012 Type C and TS16415 & AS/NZS 5532:2013

HORIZONTAL ANCHORAGE LINE SYSTEM

Extremity Anchor Posts

The IMPACT Roof Top Extremity Anchor Posts are suitable for a range of metal roof profiles and PEB structures. The post is designed with an inbuilt shock absorption mechanism which activates in the event of a fall and reduces the forces on the user's body to bearable limits and leaves the roof panel intact to maintain architectural integrity.

The Trapezoidal Extremity Post is suitable for a variety of trapezoidal roof sheets with a minimum thickness of 0.40mm for steel and 0.70mm for aluminum sheet. The posts have multiple holes to suit different peak distances. Supplied with additional weather protection EPDM sheet and flash tapes that are installed at the bottom and on top of the base plate respectively. For greater strength and stability, the center screw of the post is installed directly into the purlin of the roof.

The Standing Seam and Kliplok Roof Top Anchor Posts have been designed to adjust along the top rail ensuring total coverage of seam distances. Simply installed on standing seam or kliplok roof profiles with aluminum clamps attached to the base of the posts.



AFA935410



AFA935156



AFA935156BS



AFA935168

TECHNICAL SNAPSHOT

Extremity Anchor Posts	AFA935410	AFA935156	AFA935156BS	AFA935168
Seam Distance	195 mm to 305 mm	320 mm to 650 mm	320 mm to 750 mm	320 mm to 650 mm
Application	Trapezoidal Extremity Post suitable for roof sheets with a minimum thickness 0.40mm	Standing Seam Extremity Post	Standing Seam Extremity Post	Kliplok Extremity Post
Material	316 Stainless Steel ED Coated	6061 T6 Aluminum: Anodized 316 Stainless Steel, Electro Polished 6005 T5 Aluminum, Anodized	6061 T6 Aluminum: Anodized 316 Stainless Steel, Electro Polished 6005 T5 Aluminum, Anodized	6061 T6 Aluminum: Anodized 316 Stainless Steel, Electro Polished 6005 T5 Aluminum, Anodized
Weight	1.9 kgs	2.95 kg ± 0.05 kgs	3.214 kg + 0.050 kgs	2.47 kg ± 0.05 kgs
Operating Temperature	-40°C to +60°C	-40°C to +60°C	-40°C to +60°C	-40°C to +60°C
Inspection Frequency	Annual	Annual	Annual	Annual
MBS	15 kN	15 kN	15 kN	15 kN
Conforms to	EN 795:2012 Type C and TS16415 and AS/NZS 5532:2013	EN 795:2012 Type C and TS16415 and AS/NZS 5532:2013	EN 795:2012 Type C and TS16415 and AS/NZS 5532:2013	EN 795:2012 Type C and TS16415 and AS/NZS 5532:2013

HORIZONTAL ANCHORAGE LINE SYSTEM

Intermediate Posts

The IMPACT Roof Top Intermediate Posts are suitable for a range of metal roof profiles and PEB structures. The intermediate post is designed with an inbuilt shock absorption mechanism which activates in the event of a fall and reduces the forces on the user's body to bearable limits and leaves the roof panel intact to maintain architectural integrity.

The intermediate posts are used to divide a long line into multiple spans, reducing the sag on the line. The distance between two intermediate brackets may be between 5 to 15 meters, depending on the receiving structure.



AFA935420



AFA935157



AFA935157BS



AFA935169

TECHNICAL SNAPSHOT

Intermediate Posts	AFA935420	AFA935157	AFA935157BS	AFA935169
Seam Distance	195 mm to 305 mm	320 mm to 650 mm	320 mm to 750 mm	320 mm to 650 mm
Application	Trapezoidal Intermediate Post suitable for roof sheets with a minimum thickness 0.40mm	Standing Seam Intermediate Post	Standing Seam Intermediate Post	Kliplok Intermediate Post
Material	316 Stainless Steel ED Coated	6061 T6 Aluminum: Anodized 316 Stainless Steel, Electro Polished 6005 T5 Aluminum, Anodized	6061 T6 Aluminum: Anodized 316 Stainless Steel, Electro Polished 6005 T5 Aluminum, Anodized	6061 T6 Aluminum: Anodized 316 Stainless Steel, Electro Polished 6005 T5 Aluminum, Anodized
Weight	3.40 kg ± 0.05 kg	2.70 kg ± 0.05 kg	2.96 kg ± 0.05 kg	2.22 kg ± 0.05 kg
Operating Temperature	-40°C to +60°C	-40°C to +60°C	-40°C to +60°C	-40°C to +60°C
Span Distance	5 to 15 meters	5 to 15 meters	5 to 15 meters	5 to 15 meters
Inspection Frequency	Annual	Annual	Annual	Annual
MBS	15 kN	15 kN	15 kN	15 kN
Conforms to	EN 795:2012 Type C and TS16415 and AS/NZS 5532:2013	EN 795:2012 Type C and TS16415 and AS/NZS 5532:2013	EN 795:2012 Type C and TS16415 and AS/NZS 5532:2013	EN 795:2012 Type C and TS16415 and AS/NZS 5532:2013

HORIZONTAL ANCHORAGE LINE SYSTEM

Corner Posts

Suitable to be used in situations where the installation requires changing the direction of the horizontal line e.g: curves or corners of buildings etc. An appropriate corner post may be selected depending on the roof profile. The Corner Post is designed with an inbuilt shock absorption mechanism which activates in the event of a fall and reduces the forces on the user's body to bearable limits and leaves the roof panel intact to maintain architectural integrity



AFA935430
(60), (90), (120) Degrees



AFA935171
(60), (90), (120) Degrees



AFA935171BS
(60), (90), (120) Degrees



AFA935185
(60), (90), (120) Degrees

TECHNICAL SNAPSHOT

Corner Post	AFA935430(60) AFA935430(90) AFA935430(120)	AFA935171(60) AFA935171(90) AFA935171(120)	AFA935171BS(60) AFA935171BS(90) AFA935171BS(120)	AFA935185(60) AFA935185(90) AFA935185(120)
Design	Trapezoidal Corner Post	Standing Seam Corner	Standing Seam Corner	Kliplik Corner Post
Seam distance span	195 mm to 305 mm	320 mm to 650 mm	320 mm to 750 mm	320 mm to 650 mm
Available in	60,90 and 120 degrees	60,90 and 120 degrees	60,90 and 120 degrees	60,90 and 120 degrees
Application	The Corner Piece Is Provided To Install The Anchorage Line On Curved \ Bend Area.	The Corner Piece Is Provided To Install The Anchorage Line On Curved \ Bend Area.	The Corner Piece Is Provided To Install The Anchorage Line On Curved \ Bend Area.	The Corner Piece Is Provided To Install The Anchorage Line On Curved \ Bend Area.
Material	316 Stainless Steel ED Coated	6061 T6 Aluminum: Anodized 316 Stainless Steel, Electro Polished 6005 T5 Aluminum, Anodized	6061 T6 Aluminum: Anodized 316 Stainless Steel, Electro Polished 6005 T5 Aluminum, Anodized	6061 T6 Aluminum: Anodized 316 Stainless Steel, Electro Polished 6005 T5 Aluminum, Anodized
Weight (60),(90),(120)	2.18 kg ± 0.02 kg	3.31 kg ± 0.50 kg 3.26 kg ± 0.50 kg 3.33 kg ± 0.50 kg	3.58 kg ± 0.50 kg 3.53 kg ± 0.50 kg 3.60 kg ± 0.50 kg	2.76 kg ± 0.50 kg 2.78 kg ± 0.50 kg 3.04 kg ± 0.50 kg
Operating Temperature	-40°C to +60°C	-40°C to +60°C	-40°C to +60°C	-40°C to +60°C
Inspection Frequency	Annual	Annual	Annual	Annual
MBS	15 kN	15 kN	15 kN	15 kN
Conforms to	EN 795:2012 Type C and TS16415 and AS/NZS 5532:2013	EN 795:2012 Type C and TS16415 and AS/NZS 5532:2013	EN 795:2012 Type C and TS16415 and AS/NZS 5532:2013	EN 795:2012 Type C and TS16415 and AS/NZS 5532:2013

HORIZONTAL ANCHORAGE LINE SYSTEM

Variable Corner Bend Posts

The Variable Corner Bend Tube is attached to the intermediate which provides an inclination in lifeline by manually adjusting the angle between 0° to 45° degrees. The Intermediate Variable Corner Bend Post is designed with an inbuilt shock absorption mechanism which activates in the event of a fall and reduces the forces on the user's body to bearable limits and leaves the roof panel intact to maintain architectural integrity.

The intermediate is designed to create inclination in lifeline by manually adjusting the angle between 0° to 45°.

Minimum allowable radius on intermediate pipe is 188.0 mm which will start from minimum distance of 50 mm from centre.



AFA935430(CB)



AFA935171(CB)



AFA935171BS(CB)



AFA935185(CB)

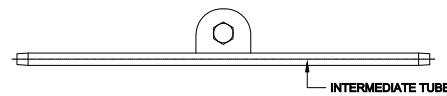
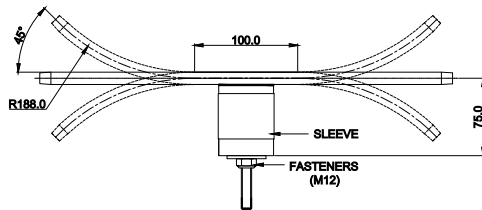





TECHNICAL SNAPSHOT

Corner Post	AFA935430(CB)	AFA935171(CB)	AFA935171BS(CB)	AFA935185(CB)
Design	Trapezoidal Corner Bend Post	Standing Seam Corner Bend Post	Standing Seam Corner Bend Post	Kliplik Corner Bend Post
Seam distance span	195 mm to 305 mm	320 mm to 650 mm	320 mm to 750 mm	320 mm to 650 mm
Application	The Corner Piece Is Provided To Install The Anchorage Line On Curved \ Bend Area.	The Corner Piece Is Provided To Install The Anchorage Line On Curved \ Bend Area.	The Corner Piece Is Provided To Install The Anchorage Line On Curved \ Bend Area.	The Corner Piece Is Provided To Install The Anchorage Line On Curved \ Bend Area.
Material	316 Stainless Steel ED Coated	6061 T6 Aluminum: Anodized 316 Stainless Steel, Electro Polished 6005 T5 Aluminum, Anodized	6061 T6 Aluminum: Anodized 316 Stainless Steel, Electro Polished 6005 T5 Aluminum, Anodized	6061 T6 Aluminum: Anodized 316 Stainless Steel, Electro Polished 6061 T5 Aluminum, Anodized
Weight	1.79 kgs	2.81 kgs	2.81 kgs	2.58 kgs
Operating Temperature	-40°C to +60°C	-40°C to +60°C	-40°C to +60°C	-40°C to +60°C
Span Distance	5 to 15 meters	5 to 15 meters	5 to 15 meters	5 to 15 meters
Inspection Frequency	Annual	Annual	Annual	Annual
MBS	15 kN	15 kN	15 kN	15 kN
Conforms to	EN 795:2012 Type C and TS16415 & AS/NZS 5532:2013	EN 795:2012 Type C and TS16415 & AS/NZS 5532:2013	EN 795:2012 Type C and TS16415 & AS/NZS 5532:2013	EN 795:2012 Type C and TS16415 & AS/NZS 5532:2013

HORIZONTAL ANCHORAGE LINE SYSTEM

Inspection Plate: AFF115101H

The Inspection Plate is installed on the tensioner side of the system for identification, traceability and maintenance of inspection records. At time of installation, the relevant details are recorded on the ID tag. The next inspection dates are also recorded on the month and year on the back of the ID plate. The label is provided with a protective aluminum frame with a poly carbonate sheet for UV protection. It is installed on the pin ring of the tensioner. The label is equipped with a dynamic QR code and an RFID tag that are linked to the Compass inspection software.

 	
KStrong Horizontal Lifelines	
AFF4000	Roof Mount - EN 795:2012 TYPE C and CEN/TS 16415:2013
AFF4000	Wall, Floor and Ceiling Mount - EN795:2012 TYPE D
Date of Installation	 
No. of users	
UID	
Line No.	
customercare@kstrong.com www.kstrong.com/asia	



Engineering Calculation
Predict forces
extremity / deflection in cable



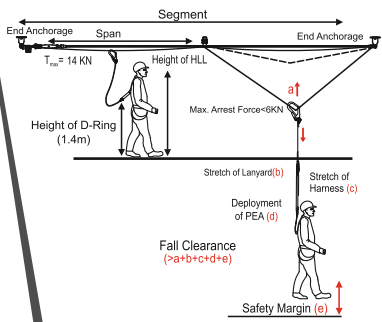

KSTRONG
UNRIVALED SAFETY.

 		
KStrong Horizontal Lifelines		
AFF4000	Roof Mount - EN 795:2012 TYPE C and CEN/TS 16415:2013	
AFF4000	Wall, Floor and Ceiling Mount - EN795:2012 TYPE D	
Date of Installation	 	
No. of users		
UID		K4000332
Line No.		
customercare@kstrong.com www.kstrong.com/asia		



Engineering Calculation
Predict forces
extremity / deflection in cable



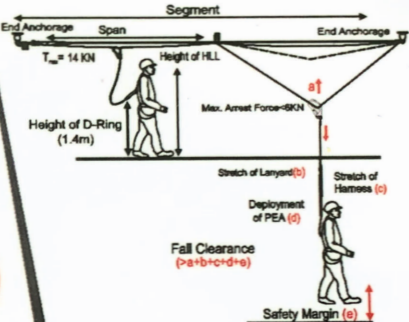

KSTRONG
UNRIVALED SAFETY.

Installation

General

Installers Responsibilities

It is the installers responsibility to familiarise themselves with the European Standards and the local legislation prior to installing the safety systems. The end users must be trained in the use of KStrong safety systems and receive and understand the user instructions supplied.

The safety system components manufactured and supplied by KStrong can only be used unless approval is given in writing prior to installation.

It is the installers responsibility to ensure that the “approved” fittings are fit for the purpose to ensure the system is fully warranted.

Under no circumstances can a KStrong component be modified or replaced by a component from another supplier.

⚠ The Installation of the system shall be carried out only by trained authorized personnel of KStrong. The installation steps given below are a brief indication of the procedure, only for the purpose of information to the user. KStrong does not take any responsibility for consequences of installation of the system if it is carried out against an authorized written recommendation by KStrong. It is necessary to ensure the safety of the installer at all stages of installation through use of correct PPE. It is also important to use correct tools as recommended by KStrong for installation.

Ensure safety of the installer at all stages. Use correct PPE while installing.

Tools Required - refer to page no. 35

Trapezoidal Post Assembly

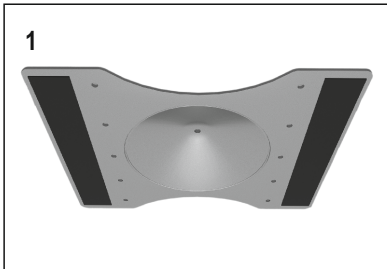

Apply adhesive waterproofing membrane under rivet location on plate.

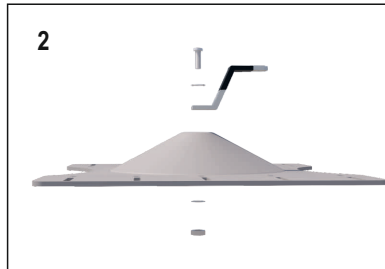

Attach anchor on top of base plate and insert bolt through anchor, top washer, base plate and tighten bottom recessed washer. Ensure torque setting is 17 Nm.

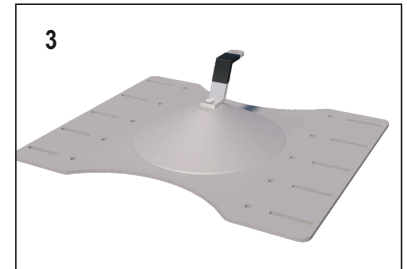

The Impact post is now ready to be installed on the roof profile as part of the system.

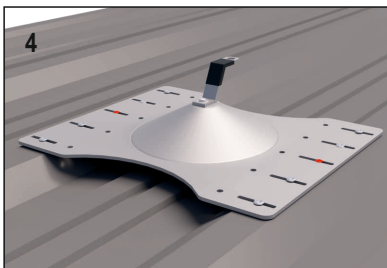

Now repeat process for the intermediate, corner posts and variable corner bends

Installation of Trapezoidal Posts

Step 1 : Extremity Post AFA935410

- Stick the base plates of the post to the roof with double adhesive EPDM sheet.
- The center holes should be on the purlin. Fasten 2 x 14g x 75mm roofing screws directly into the center hole on either side of the base plate thru the roof sheet and purlins below (use the same length of screws currently installed in the roof sheets to the purlins).
- Drill 8 holes for the blind rivets, (four on each side) and rivet with a riveting gun.
- Cover the rivets with a weather proofing flash tape.

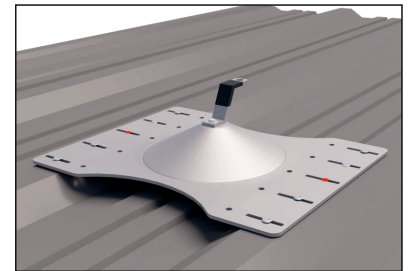
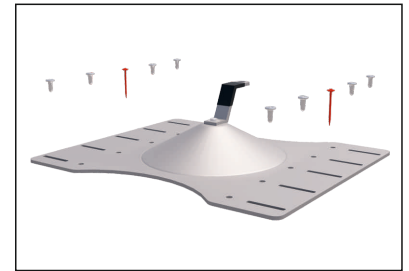
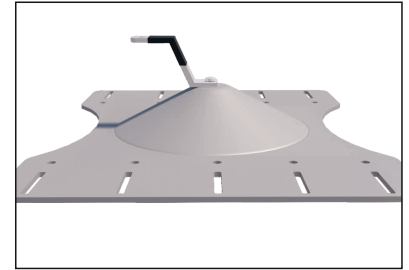

TECHNICAL SNAPSHOT

FASTENERS

Type	Blind Rivet	Self Drilling screws
Size(mm)	8	14g x 75mm
Qty	8	2

Step 2 : Intermediate Post AFA935420

- Stick the base plates of the post to the roof with double adhesive EPDM sheet.
- The center holes should be on the purlin. Fasten 2 x 14g x 75mm roofing screws directly into the center hole on the either side of the base plate thru the roof sheet and into the purlins below.(use the same length of screws currently installed in the roof sheets to purlins).
- Drill 8 holes for the blind rivets, (four on each side) and rivet with a riveting gun.
- Cover the rivets with a weather proofing flash tape.

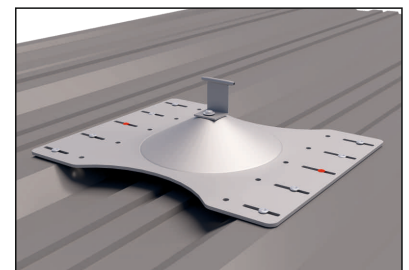
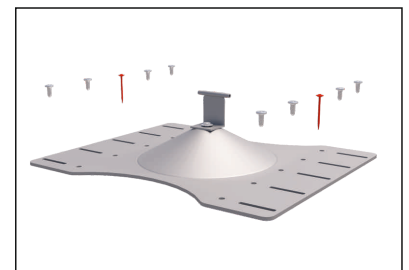

Step 3 : Intermediate Bracket

- Insert the cable through the intermediate tube
- Pull the cable manually to reduce the sag in the adjacent span
- Fix a U bolt to prevent the cable from loosening. Remove the U bolts after the life line is connected to the tensioner and then the pretension is applied to the entire lifeline

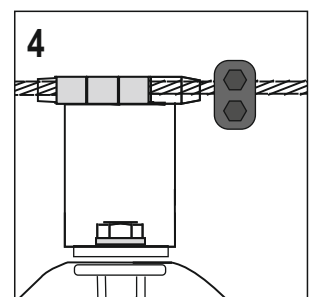
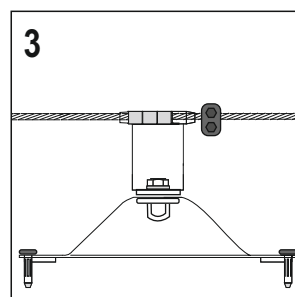
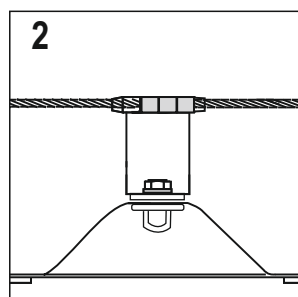
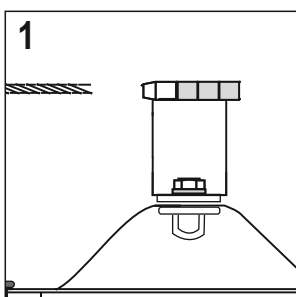

HORIZONTAL ANCHORAGE LINE SYSTEM

Step 4 : Corner AFA935430 (60, 90 & 120) & Variable Corner bends AFA935430(CB)

- Install the post as described in Step 2.
- Insert the cable through the tube.
Pull the cable manually to reduce the sag in the adjacent span.
- Fix a U bolt to prevent the cable from loosening. Remove the U bolts after the lifeline is connected to the tensioner and then the pretension is applied to the entire lifeline.

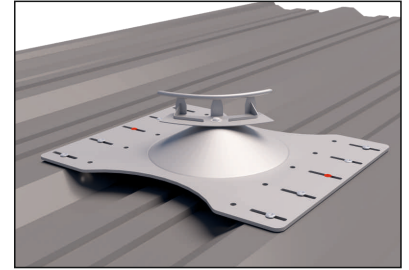

Water Proofing

Water leak testing is done by running water from fire hose on the roof and then checking the roof for any leakage near the rivets. The Impact Series offers 4 layers of protection:

- EPDM water proofing tape between the roof and the bottom plate of the post.
- The rivets & tek screws have a neoprene rubber washer for water proofing.
- The bulb type dome shape rivets prevent water logging near the rivets.
- For extra protection, the rivets can be covered with an EPDM tape. (You will need to order additional EPDM tape)
- The neoprene washer in the rivet is never exposed to atmosphere ensuring the neoprene washer won't degrade with passage of time.



Rivets 7.7 x 27.7 Long (Green seal)



14g x 75mm Roofing Screws

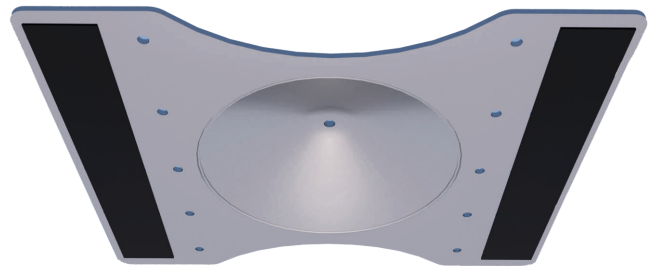

Trapezoidal Base Plate with EPDM Tape

Standing Seam Post Assembly

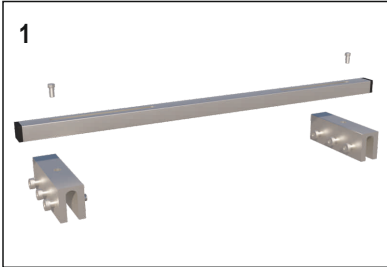

1
Place cross beam over clips and insert bolt into the beam and seam clip below

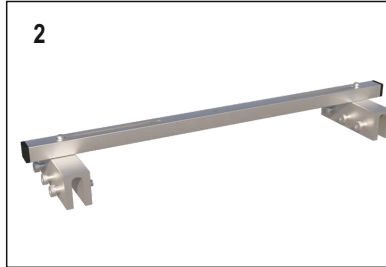

2
Place the steel washer onto the bolt and tighten bolt to the correct torque settings (refer torque settings chart page 24), making certain the cross beam and seam clips are secure.



3
Insert bolt through plain washer, anchor and beam. Place the washer and nyloc nut onto the bottom of the bolt. Tighten nut and bolt to the correct torque settings (refer torque settings chart page 24)

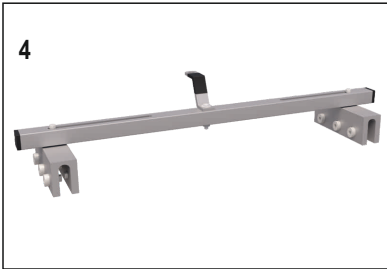

4
Install the post directly over the standing seam and tighten to secure. Tighten nut and bolt to the correct torque settings (refer torque settings chart page 24)

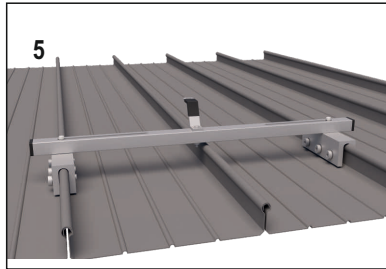

5
Now repeat process for the intermediate, corner posts and variable corner bends.

Installation of Standing Seam Posts

Step 1 : Extremity Post AFA935156

- The post clamps come with pre-installed hex bolts and grub screws. Slightly loosen all grub screws which allows the clamp to fit directly over the standing seam.
- Ensure that the flat side of each clamp must be above the lip of each respective metal roof seam.
- Now tighten all the clamps with the correct torque
- Mount the roof post square tube on the seam clips with hex bolts .

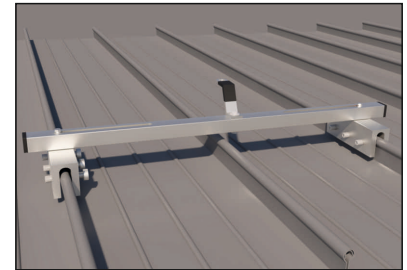
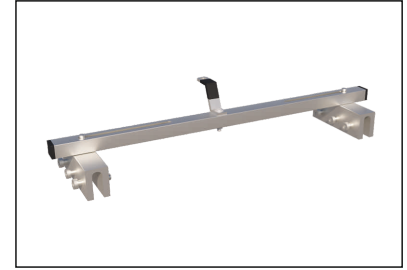

STANDING SEAM FASTENERS / CONNECTOR TORQUE SETTINGS

Type	Grub Screw	Hex Bolt	Hex Bolt
Size(mm)	10X25	10X25	12X25
Qty	6	6	3
Torque	15 Nm	17 Nm	17 Nm

Step 2 : Intermediate Post AFA935157

- The post clamps come with pre-installed hex bolts and grub screws. Slightly loosen all grub screws which allows the clamp to fit directly over the standing seam.
- Ensure that the flat side of each clamp must be above the lip of each respective metal roof seam.
- Now tighten all the clamps with the correct torque
- Mount the roof post square tube on the seam clips with hex bolts .

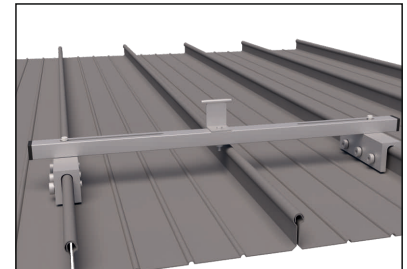

Step 3 : Intermediate Bracket

- Insert the cable through the intermediate tube
- Pull the cable manually to reduce the sag in the adjacent span
- Fix a U bolt to prevent the cable from loosening. Remove the U bolts after the life line is connected to the tensioner and then the pretension is applied to the entire lifeline

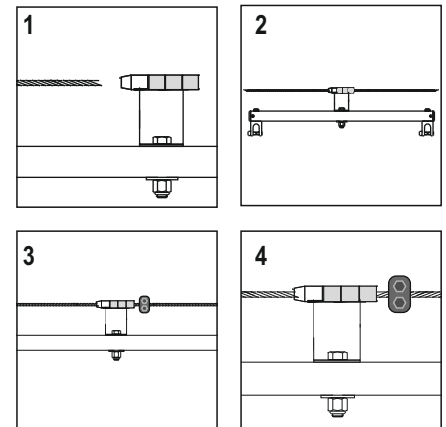

Step 4 : Corner Post AFA935170

- Install the post as described in Step 2.
Insert the cable through the corner tube
Pull the cable manually to reduce the sag in the adjacent span
- Fix a U bolt to prevent the cable from loosening. Remove the U bolts after the lifeline is connected to the tensioner and then the pretension is applied to to the entire lifeline

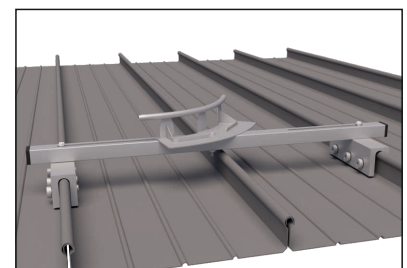

HORIZONTAL ANCHORAGE LINE SYSTEM

Kliplok Post Assembly

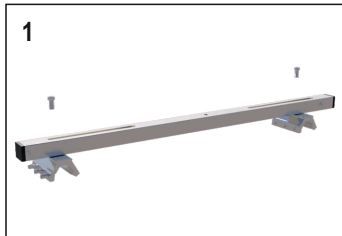

1
Place cross beam over Kliplok and insert bolt into the beam and Kliplok below

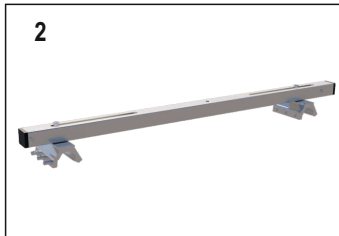

2
Place the steel washer onto the bolt and tighten bolt to the correct torque settings (refer torque settings chart page 26), making certain the cross beam and seam clips are secure.

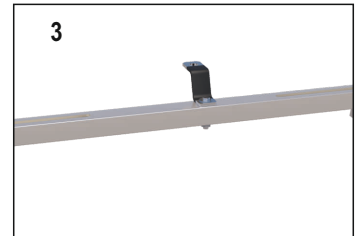

3
Insert bolt through plain washer, anchor and beam. Place the washer and nyloc nut onto the bottom of the bolt. Tighten nut and bolt to the correct torque settings (refer torque settings chart page 26)

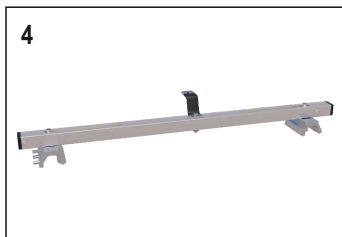

4
Install the post directly over the Kliplok and tighten to secure (refer torque settings chart page 26)

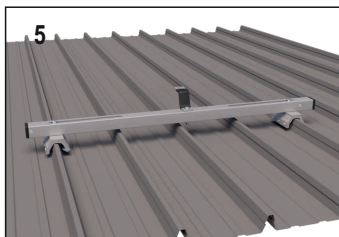

5
Now repeat process for the intermediate, corner posts and variable corner bends.

NOTE:

Please ensure you select one of the clamps below to suit the Kliplok Roof Profile

AFA935176 - IMPACT KLIPLOK BASE POST CLAMPS SUIT KLIPLOK 770

AFA935174 - IMPACT KLIPLOK BASE POST CLAMPS SUIT KLIPLOK 406

AFA935178 - IMPACT KLIPLOK BASE POST CLAMPS SUIT KLIPLOK 700

HORIZONTAL ANCHORAGE LINE SYSTEM

Installation of Kliplok Posts

Step 1 : Extremity Post AFA935168

- The post clamp comes with pre-installed hex bolts and grub screws. Slightly loosen all grub screws which allows the clamp to fit directly over the Kliplok profile
- Ensure that the flat side of each clamp must be under the lip of each Kliplok profile.
- Now tighten all the clamps with the correct torque
- Mount the roof post square tube on the with hex bolts.

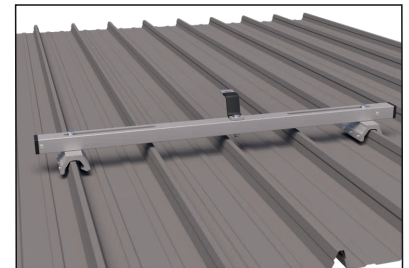
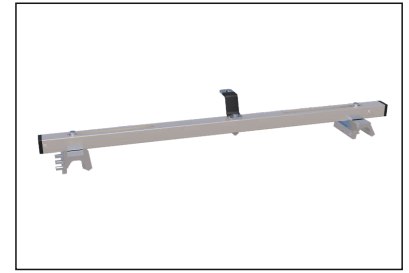

KLIPLOK FASTENERS / CONNECTOR TORQUE SETTINGS

Type	Grub Screw	Hex Bolt	Hex Bolt
Size(mm)	10X25	10X25	12X25
Qty	5	2	1
Torque	15 Nm	17 Nm	17 Nm

Step 2 : Intermediate Post AFA935169

- With grub screws hex bolts fix the two Kliplok clamps to the seam.
- Mount the roof post square tube on the seam clips with hex bolts.

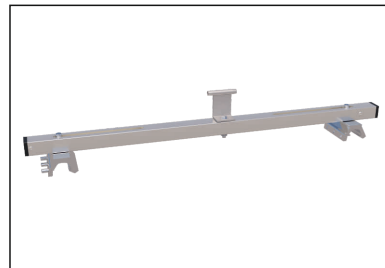

Step 3 : Intermediate Bracket

- Insert the cable through the intermediate tube
- Pull the cable manually to reduce the sag in the adjacent span
- Fix a U bolt to prevent the cable from loosening. Remove the U bolts after the life line is connected to the tensioner and then the pretension is applied to the entire lifeline

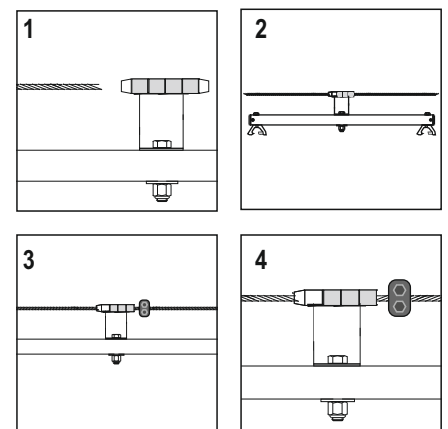

Step 4 : Corner Post AFA935170

- Install the post as described in Step 2.
Insert the cable through the corner tube
Pull the cable manually to reduce the sag in the adjacent span
- Fix a U bolt to prevent the cable from loosening. Remove the U bolts after the lifeline is connected to the tensioner and then the pretension is applied to to the entire lifeline

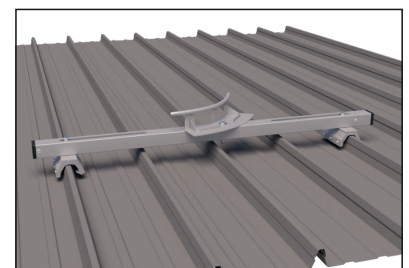

Installation of the System

Step 1: Swaging & adding Extremity Stopper

Equipment

- **Swaging Tool**

- The swaging Tool is the most important equipment to ensure a robust swage. Swaging must be performed by a hydraulic Swaging tool capable of providing a force of 120kN.

Note: Please use the right swaging tool.

- **Hex Loc Die.**

- Selection of the right size of Hex loc die is critical. Ensure that the hex loc Die has dimensions as in the Fig1.

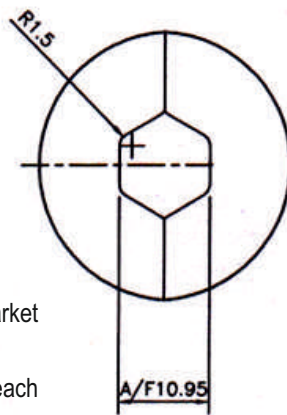

Note1: The size of the Die available on the market nearest to the recommended size in Fig.1 is 50mm²

Note2: Inspect for wear and tear of the dies before each swaging .Replace the dies if the edges are rounded.

Process

- Insert the cable into the swage tube. Mark the cable by a marker at the edge of the swage tube. Pull the cable out of the swage tube and check if the cable had been inserted fully ,by placing the cable over the swage tube.
- Insert the Cable in the tube again, until the edge of the swage tube coincides with the marking on the cable. We now know that the cable has been fully inserted in the swage tube.
- The swage tube is marked to identify exact positions of swaging.
- Place the swage tube on the hex loc die of the hydraulic swaging tool. See Fig2
- While placing the swage tube on the hex loc die, ensure that the mark on the swage tube is in the center of the die.
- Set the hydraulic swaging tool to 120kN force.
- Apply a slight force on the swage by pressing the switch of the swaging tool and releasing it to ensure that the swaging has started and the swage is placed in the right position. Now press the switch again to provide the required 120 kN Pressure. Continue Pressing the switch until the green light is on , to indicate that the 120kN force has been achieved.
- Repeat the process for all markings. Rotate the Swage at 90 degrees after each
- Swaging to ensure that the tube does not bend.
- To ensure that the tube does not bend the following sequence of swaging may be followed as good practice.
1st swage: Top
2nd swage: Bottom
3rd &4th swage: Middle
5th and 6th swage: Remaining swage.
- Check the tube after each swaging for any signs of bending. Decrease/increase Rotation of the tube if required to offset the bend due to previous swaging.

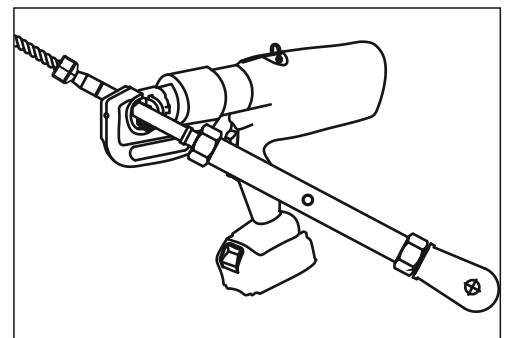

Fig:1

HORIZONTAL ANCHORAGE LINE SYSTEM

Applying Tension To the line Hold the tensioner eye.

- Insert the tensioning tool in the housing of the tensioner and rotate the tensioner in clock wise direction. Rotate it until reasonable tension is achieved in the cable and the tension indicator plate is in contact with the shock absorber coil.
- Tighten both the chuck nuts.

Mounting the tensioner on the system

- Open the threads of the tensioner from both ends until red mark on the thread is visible.
- Insert the locking pin so as to pass the eye of the tensioner and the shock absorber.
- Insert a pin ring in the locking pin to lock it.

Mounting the tensioner on the system.

- Open the threads of the tensioner from both ends. Ensure 75% of the thread is open.
- Insert the locking pin so as to pass through the eye of the tensioner and the shock absorber.
- Insert the label ID tag in the pin ring and the locking pin to lock it.

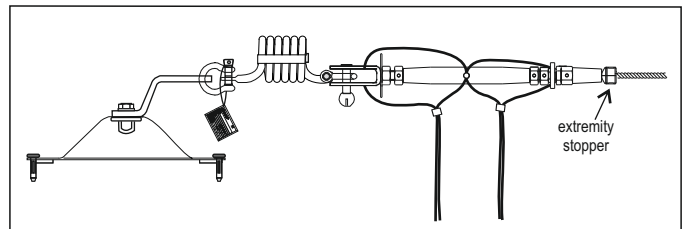

Applying Tension To the line:

- Hold the tensioner eye.
- Insert the tensioning tool in the housing of tensioner and rotate tensioner in clock wise direction. Tension should be applied slowly.
- After terminating the wire, tension the cable to ensure the sag in the last span is reduced. Remove the U bolts that have been previously installed after each intermediate.
- Now tension the cable again until the TFI starts rotating freely, this ensures adequate amount of tension has been achieved in lifeline.
- Tighten both the chuck nuts.
- Tighten the grub screws on chuck nuts.
- Tie the tie cords and lock them with ferrule.

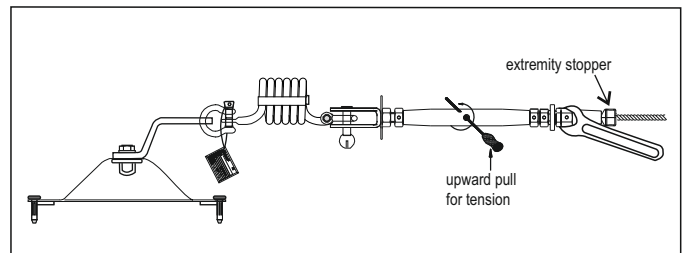

Step 2: Tensioner Termination

2.1 Swageless Termination-AFF114100(SL)

Swage less termination of cable in end extremity

- Insert the cable in to the housing of the cable extremity.
- Open the strands of the cable.
- Insert the core of the cable in the poke pin (the strand which is straight is core, the other strands are twisted.)
- With a hollow Center punch hammer the poke pin deep inside the housing of the cable extremity.
- Tighten the connector of the extremity to the housing of the cable extremity.

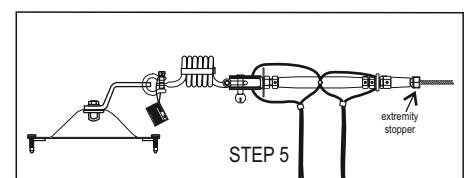
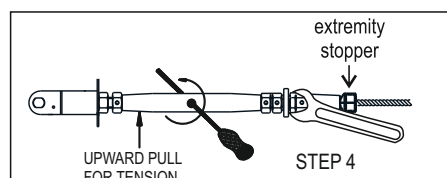
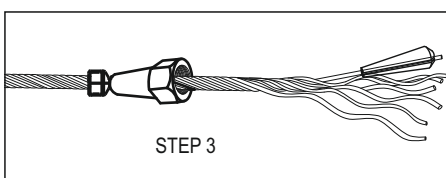
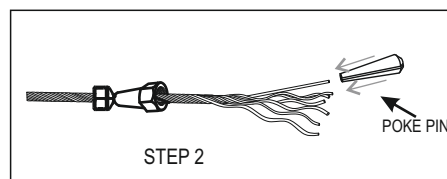
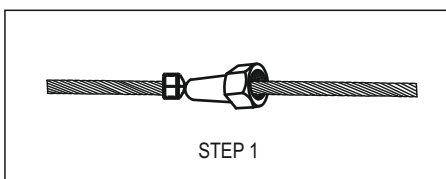

HORIZONTAL ANCHORAGE LINE SYSTEM

Step 3 : Shock Absorber-AFF112100

- Attach the D Shackle to the shock absorbing eye of the extremity post (see figure 1)
- Connect the other D Shackle to the tensioner
- Take the shock absorber out of service when the shock absorber coil is is elongated due to an impact from a fall of the user.

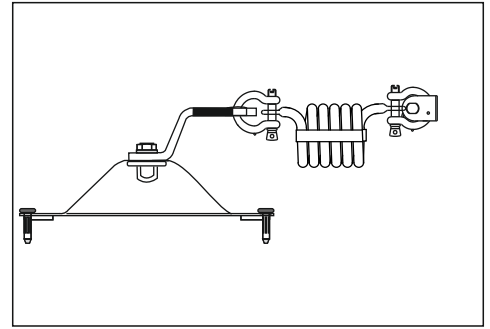

TECHNICAL SNAPSHOT

FASTENERS/CONNECTOR

TYPE	SIZE(mm)	QTY
D SHACKLE	AFF112100D	2

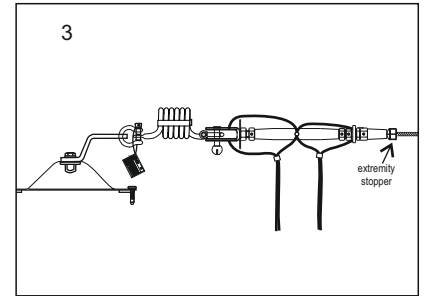
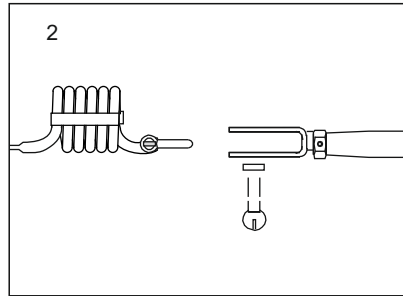
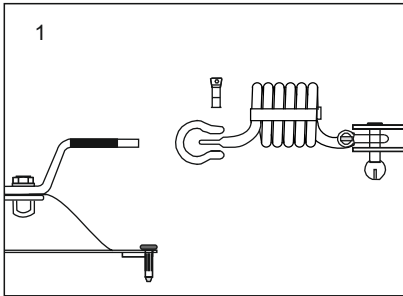

Step 4 : Intermediate Post AFF935420, AFF935157 and AFF935169

- Insert the cable through the intermediate tube (refer to figures 1 & 2).
- Pull the cable manually to reduce the sag in the adjacent span.
- Fix a U bolt to prevent the cable from loosening. Remove the U bolts after the lifeline is connected to the tensioner and then the pretension is applied to the entire life line (refer to figures 3 & 4).

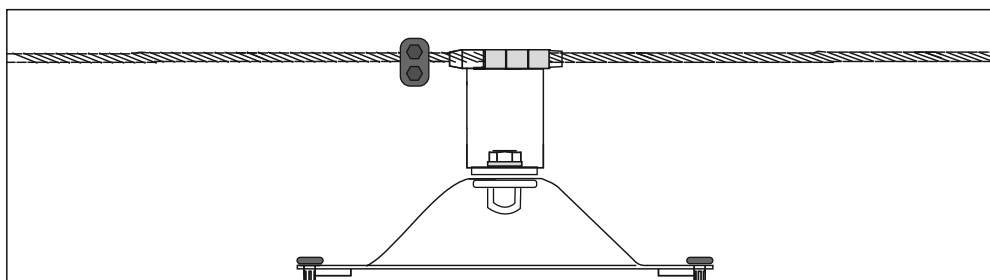
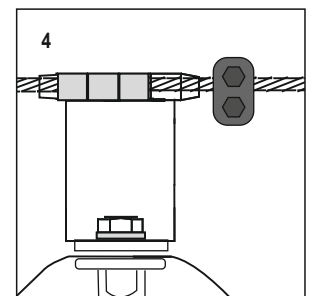
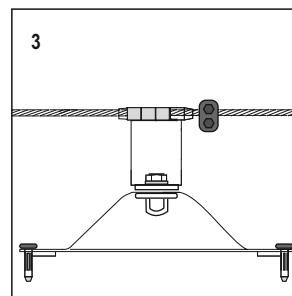
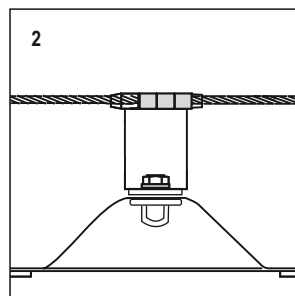
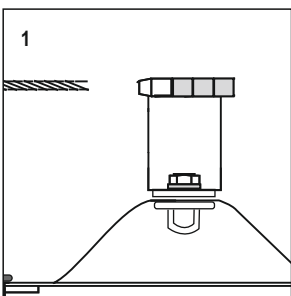

HORIZONTAL ANCHORAGE LINE SYSTEM

Step 5: Cable Extremity Swaged & Swageless

Cable Extremity Swageless

- Insert the cable in to the housing of the cable extremity.
- Open the strands of the wire.
- Insert the core of the cable in the poke pin. The strand which is straight is the core, the other strands are twisted.
- With a hollow Centre punch, hammer the poke pin deep inside the housing of the cable extremity.
- Tighten the connector of the extremity to the housing of the cable extremity
- Connect the cable extremity to the universal end extremity plate by a locking pin.
- Insert the pin ring in to the locking pin to lock.
- Install the extremity stopper at thru the wire at the end of tensioner.

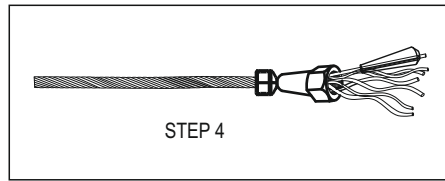
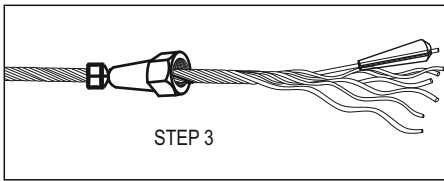
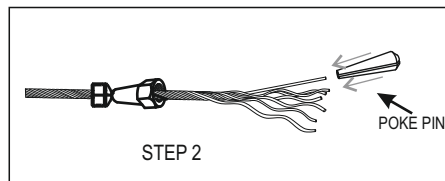
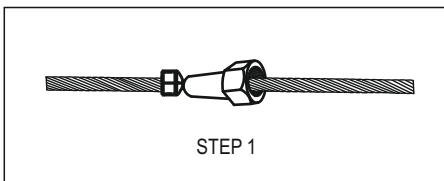

Cable Extremity Swaging-AFF113210

- Insert the cable into the swage tube.
- The swage tube has markings to identify exact positions of crimping.
- Place the swage tube on the hex loc die of a hydraulic crimping tool(130kN capacity).
- Ensure that the mark on the swage tube is in the center of the die.
- Operate the machine to start the swaging operation until the green light is on.
- Repeat the process for all markings (5 times minimum).
- Proof load the termination to 6kN using a hydraulic testing machine.

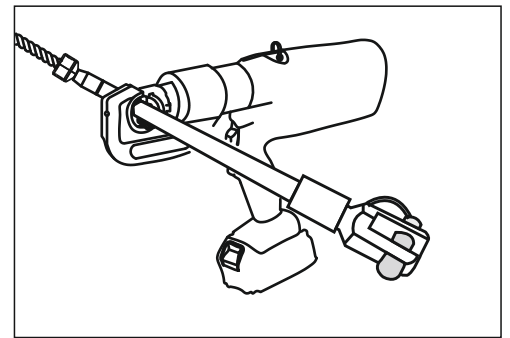

Cable Extremity attaching to extremity post

Insert the eye of the cable extremity in to the shock absorbing eye of the extremity post. Pass the pin through the cable extremity and shock absorbing eye.

Lock the pin using a pin ring.

Install the extremity stopper thru the wire before the end of extremity anchor.

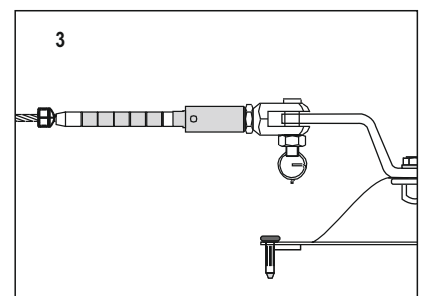
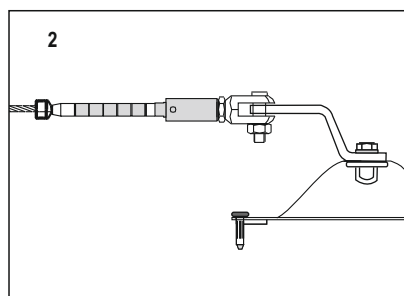
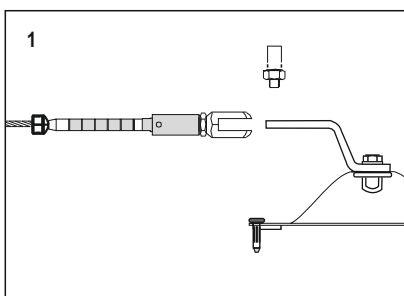

Pre-Use Checks and Precautions

Post Installation Inspection

- Once installed, it is important to inspect the complete line by moving the entire length of life line
- It is mandatory for the Site Inspector/ Supervisor and the actual users of the system to perform a thorough check before carrying out work. KStrong conducts a brief training of all concerned personnel on the subject of pre-use inspection of the system as per a defined guideline after the system has been installed by KStrong personnel.

Checking the receiving structure

Do not install the system if the receiving structure does not meet the minimum structural strength of 12kN. If in doubt, refer to an Engineer.

Checking the System

- Clean the system from dust/dirt. Check for any mechanical defects.
- Check for wear and tear in all components or unusual bending or deformation.
- Check for any modifications done by the user.
- Check for any missing component.
- Check for any damages that may have been caused due to welding while maintenance of other equipment.
- Check the identification plate. The system needs to be put out of service if the label is not legible or missing.

Checking the Cable

- See that there is sufficient tension on the cable by checking the tension indicator in the shock absorber.
- Check the condition of the cable. Wear hand gloves and check the wire from all sides. Check for broken strands or any deformity in the cable. Report if strands are found broken.

Checking the Carriage Body

- Check the smooth movement of the carriage body before each usage. If friction is noticed, it can be due to dust accumulated due to continuous use. Clean the carriage with a soft cloth using silicon spray
- Only use a karabiner at the termination end of the lanyard to slide the carriage body on the cable.

Precautions While Using the System

The following points and precautions needs to be considered for safe use of the system

- The life line is for the purpose of fall protection while working on a horizontal plane at height. A back up fall arrest system is required when transitioning on and off the life line system while working at height.
- Never disengage the fall arresting lanyard and the carriage body from the life line while working at height.
- Avoid using grease to lubricate the system. If any fall is reported, put the system out of use. Contact the manufacturer for repairs and re-validation.
- Only certified full body harness with proper attachment anchorage points should be worn while using the AFF4000 system.
- Do not alter or misuse this equipment. Always take the advice from KStrong personnel while using this equipment in combination with components or subsystems other than those described in this manual. Usage of certain component/sub system may interfere with the proper functioning of this equipment and the system may not deliver or work as per its intended use. In such case, KStrong may not be held responsible for any malfunction.
- The lifelines must be kept free from dust, grease etc., by periodic cleaning. The system can be cleaned by a soft dry cloth.

Hazards

Hazards existing in immediate environment may require additional precautions to limit the possibility of injury to the user or damage to the equipment. Hazards may include but are not limited to, extreme temperatures, caustic chemicals, corrosive environments, high voltage power lines, explosive or toxic gases, moving machinery, sharp edges, high velocity winds, etc.

Do not expose the equipment to any hazard which it is not designed to withstand. Consult the manufacturer if in doubt.

Rescue Plan

It is recommended to ensure that the user shall have a rescue plan and means to execute it while using this equipment. The rescue plan needs to be project specific. The employees must be trained in self-rescue or alternative means shall be provided for prompt rescue in an event of a fall.

It is recommended to work in a pair to ensure that in an event of a fall your partner may help in rescue.

Annual Inspection & Revalidation

According to the requirement of EN365, every PPE needs to be inspected at least once in a year. The KStrong Compass software maintains the data of the system for at least 20 years and reminds the client whenever the inspection is due. The KStrong Inspection Team is trained to perform the inspection and provide a certificate each year at a nominal cost. The client may at any given moment of time extract the status of any of the lifeline installed anywhere in the world from the KStrong data base.

Environment

To protect the environment, KStrong follows a 100% paperless process. Unless specifically required, KStrong avoids printing its reports and make it available to the client digitally.

HORIZONTAL ANCHORAGE LINE SYSTEM

Inspection Use and Maintenance

PPE Inspection and Revalidation

Fall Protection Equipment is a life saving product. As per the EN 365 of PPE regulations 425/2016, it is mandatory to have a 'Competent Authority' to inspect the Fall Protection Equipment at least once annually.

KStrong Compass Inspection software helps taking care of the equipment.



- Cloud based online as well as off line software
- Captures geo coordinates where the system is installed
- RFID / Bar code compliant
- Generates report in real time
- Reminds user of items due for inspection
- Captures images of components
- User customizable
- Can be integrated to client software
- Reports can be shared with multiple recipients in real time

Infrastructure

- Good quality equipment complying with international standards
- 100% backward oriented manufacturing unit
- Qualified engineering crew
- Sophisticated test equipment
- Precise engineering software to understand the client requirement to provide a safe & optimum solution
- Technical marketing team capable of understanding the client requirement & present the solution using engineering drawings (Auto CAD) & calculations
- Force predictions on the system in an event of a fall and a testing facility to validate the force calculations

HORIZONTAL ANCHORAGE LINE SYSTEM

Fixed Life Line System Projects can be Executed in 3 Steps :

Site Visit

- Site engineer visits the client's site to check & understand the requirement.
- Site measurements using sophisticated equipments like digital distance meter & special imaging tools.
- Simulations of forces on the receiving structure using advanced engineering software like STADPRO.

Providing Good Quality Material

- MOC of KStrong fixed line components is stainless steel grade 316 and aluminum which are tested using a spectrophotometer to ensure the quality parameters.
- State of the art test lab using high precision dynamometers, oscilloscopes & slow motion cameras to validate predictions & simulations claimed.
- The only manufacturer having 100% backward oriented plant & undertaking to supply spares for a minimum period of 20 years.

Installation

- Proof loading of the system using Hydra Jaws (UK) equipment for onsite horizontal lifeline testing; post execution care.
- Software based support for inspection of the system annually.

Warranty

The system is produced with extreme precision. Should there arise a manufacturing defect within a period of 2 year of supply, KStrong stands to repair the components or replace if necessary.

Warranty does not cover:

- Deficiency arising out of misuse of equipment
- Malfunction due to faulty installation/wrong usage of product
- This equipment is not user maintainable. The warranty stands void if an attempt is made to repair or open the equipment.

KStrong does not provide a product functioning warranty; the warranty stands for the workmanship of the products only.

- KStrong systems are made of stainless steel grade 316, ED coated steel or aluminum and are highly resistant to corrosion.
- KStrong systems are thus further warrantied for 20 years (15 years for Marine Environment) provided they are inspected once annually according to the requirements of EN365.

HORIZONTAL ANCHORAGE LINE SYSTEM

Tools Required



RING SPANNER



DOUBLE END SPANNER



SOCKET SET



TENSIONER TIGHTENING TOOL



CRIMPING PLIER



BOLT CUTTER



ALLEN KEY

Machines



CORDLESS DRILL MACHINE



HAMMER DRILL MACHINE



CORDLESS IMPACT WRENCH



HYDRA JAWS
LIFELINE TESTING



SWAGING TOOL



HYDRAULIC CRIMPING HEAD







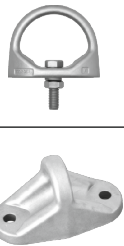

POWER BIRD RIVETING MACHINE

Anchors



HORIZONTAL ANCHORAGE LINE SYSTEM

Measuring Tools

					
TAPE	DETECTOR	DIGITAL TORQUE WRENCH	DISTANCE METER	LASER TOOL	VERNIER

Consumables, Miscellaneous Tools

						
DUST PUMP	HOLE SAW CUTTER	HOT AIR GUN	SETTING TOOL	PAINT BRUSH	DRILL BIT	IMPACT DRILL
						
BLOWER	CHEMICAL APPLICATOR					

WRENCH SIZE					
Hex Bolt	6	8	10	12	16
Wrench Size	10	13	16	19	24
Socket Size	10	13	16	19	24

ALLEN KEY SIZE				
Allen Bolt Size	6	8	10	12
Allen Key Size	4	6	8	10
Allen Grub Screw Key Size	3	4	5	6

Torque Chart (Maximum torque for standard bolts)

CHART							
Bolt size	M6	M8	M10	M12	M14	M16	M10 Standing Seam
Recommended Torque:	17 Nm	30 Nm	45 Nm	50 Nm	56 Nm	70 Nm	26 Nm

Proof Load Test

Process of Proof Loading of Horizontal and Vertical Lifelines

Proof loading of roof post (Non Destructive)

- Post installation at least 10% of the posts should be proof loaded by a load testing device .The posts should be subjected to a static load of 1.0 kN for a period of 1 minute in accordance with EN 795 (4.4.1.1).The permanent deflection as a result of proof loading should not be greater than 10 mm after the load is released

Proof loading of termination(Non Destructive)

- Each cable end termination should be proof loaded by a load testing device, to a static force of 6 kN.The force is held for 1 minute. The proof loading ensures that the end cable terminations are robust and will not release the cable in an event of a fall.

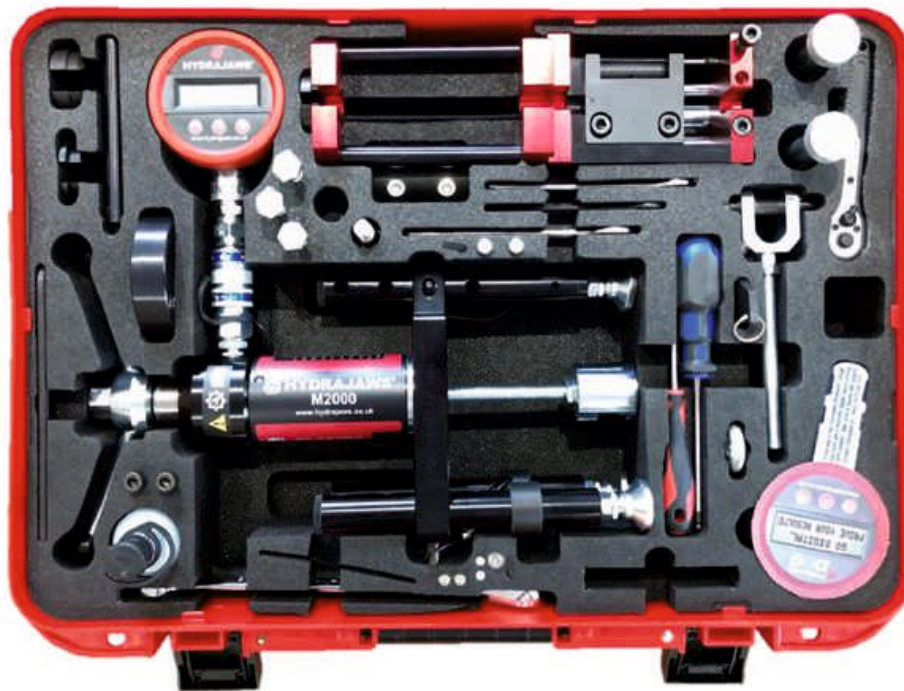

HYDRA JAWS LIFELINE TESTING

HORIZONTAL ANCHORAGE LINE SYSTEM

Inspection Log

EQUIPMENT RECORD				
Product				
Model & type/Identification		Trade Name		Identification number
Manufacturer		Address		Tel, Email
Year of manufacture		Purchase Date		Date first put into use
Other relevant information (eg. document number)				
PERIODIC EXAMINATION AND REPAIR HISTORY				
Date	Reason for entry (periodic examination or repair)	Defects noted, repairs carried out and other relevant information	Name and signature of competent person	Periodic examination next due date



KStrong Asia Pte Ltd
33A Chander Road,
Singapore 219539
www.kstrong.com

USA

South America

Asia
