



USER INSTRUCTION MANUAL
EXTREME DAVIT

THESE INSTRUCTIONS APPLY TO THE FOLLOWING MODELS:

AFT7500, AFT7500BF, AFT7500BW

CE 0598



II 2G
Ex h IIc T6 Gb

EN 80079-36:2016
EN 80079-37:2016

Please read and understand the manufacturer's instructions for each component or part of the complete system. Manufacturer's instructions must be followed for proper use, care, and maintenance of this product. These instructions must be retained and be kept available for the user's reference at all times. Alterations or misuse of this product, or failure to follow instructions, may result in serious injury or death.

Note: The user is advised to keep this user instructions document for the life of the product.

1. **INTRODUCTION:** This instruction manual is applicable to the Extreme Davit (AFT7500) and is drafted in accordance to EN 795:2012 Type B and must be available at the place of installation. If this device is sold, the instruction manual must be included in the local language.
2. **APPLICABLE SAFETY STANDARDS:** The Extreme Davit (AFT7500) is classed as a Personal Protective Equipment (PPE) by the European PPE Regulation (EU) 2016/425 and has been shown to comply with this Directive through the Harmonized European Standard EN 795:2012 Type B. This product is designed to minimize the risk of/provide protection against the danger of falling from heights. However, always remember that no item of PPE can provide full protection and care must always be taken while carrying out the risk related activity.
3. **APPLICATION :** KStrong Extreme Davit provides a safe and secure system for easy access to confined spaces. The Extreme Davit is an ideal choice to provide overhead anchorage which can be mounted on different bases.
4. **INSPECTION :** Visually inspect the system before each use to ensure that it is in a serviceable condition and is operating correctly. If during inspection, doubts are raised about the safety of the system or a component, these should be replaced either by the manufacturer or a competent person.
5. **PRECAUTIONS:**
 - Ensure the Medical condition of the user does not affect his safety in normal and emergency use.
 - The equipment shall only be used by a person trained and competent in its safe use.
 - A rescue plan shall be in place to deal with any emergencies that could arise during the work.
 - It is essential to verify the free space required beneath the user at work place before each occasion of use so that in case of a fall there will be no collision with ground or other obstacle in the fall path.
6. **PRE-USE CHECK: ENSURE THAT:**
 - The user should carry out a pre-use check of the Extreme Davit, to ensure that it is in a serviceable condition and operates correctly before it is used.
 - The pre use check shall involve checking of any wear or abrasion on wire rope and sign of cuts, frays, damage.
 - All locking pins are in locked position.
 - Extreme Davit column and extension arm are not distorted or damaged.
 - All bolts and screws are tightened.
 - Wall mounting bracket / Floor mounting brackets are properly installed.
 - Wire rope of winch / retractable fall arrester is free of cuts, and corrosion.
7. **GENERAL INSTRUCTIONS FOR USE OF Extreme Davit:**
 - The Extreme Davit shall be used only for Vertical movement, up or down.
 - Suitable for use only for up to a weight of 140 kg.
 - Ensure that the Harness complies with EN 361, is adjusted to the user's size, is free from damage and is in good condition.
 - Also ensure that the date on which the equipment must be returned to the manufacturer for yearly inspection is not exceeded.

MINIMUM MOUNTING REQUIREMENTS FOR DAVIT BASE:	
Moment Load for the structure	10kN (2238lbs)
Vertical Load for the structure	15kN (3372lbs)
Structure resistance validation and installation execution must be performed by a certified person.	

8. PRODUCT DESCRIPTION:



Fig. 1
Locking pin to adjust the extension arm in 3 Positions.

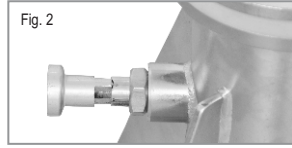

Fig. 2
Locking pin for securing Column into the Floor Mounting /Wall Mounting Bracket in desired position.

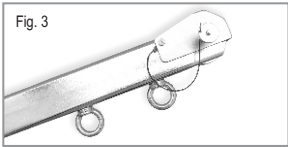

Fig. 3
Two Additional attachment points which can be used as anchorage point for Retractable fall arrester.

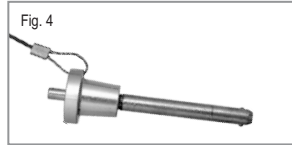

Fig. 4
Big locking pin for securing extension arm on the column.

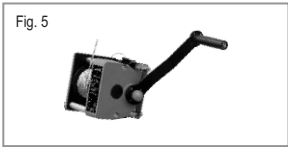

Fig. 5
Brute Winch (AFT730020)



Fig. 6
Floor Mounting Bracket (AFT7500BF)



Fig. 7
Wall Mounting Bracket (AFT7500BW)



Fig. 8
AFT7500B20 for AFS510020R



Fig. 9
AFT7500B30 for AFS510030R



Fig. 10
Rescue Retrieval Block (AFS510020R/AFS510030R)

NOTICE: Preparing the apparatus for use requires prior knowledge of proper mounting procedure of the mounting brackets. The bolts or screws required for mounting the floor mounting device, do not come with the product. Please refer to an Engineer to verify the structure is suitable for the installation.

9. HOW TO INSTALL -

Installation requirements of Davit Floor & Wall Mount Base:

Structure : The receiving structure must be able to withstand stresses equivalent to 22.1 MPa or 22.1N/mm². The fasteners/structural anchors must be strong enough to handle this strain. Refer Fastener manufactures UIM for stainless steel/High tensile M16 fasteners.

Floor Mount Base (AFT7500BF) are designed for mounting to concrete or steel structures.

Installation :

- Thickness of concrete block should be minimum 9"(228.6mm)
- All receiving Structures should be verified by a qualified structural Engineer.
- Base Installation must be approved to local regulations by a qualified engineer.
- Refer to Fastener Manufacturer to ensure the correct fasteners are used.
- If the Base material does not meet the minimum requires to install, then reinforcement is required. Refer to a qualified engineer.
- Drill holes should have a minimum clearance of 11"(279.4mm) from all available edges
- If unsure, refer to a qualified engineer to recommend the location to mount the Floor mount base to the structure.
- Drill 4 holes using the base as a guide
- Install the recommended M16 fasteners and mount the base then tighten the bolts.
- Can also be installed on cantilever of concrete beam by sand-witching two plates on concrete structure
- Suitable M16 fasteners should be used for fixing the brackets to the structure.

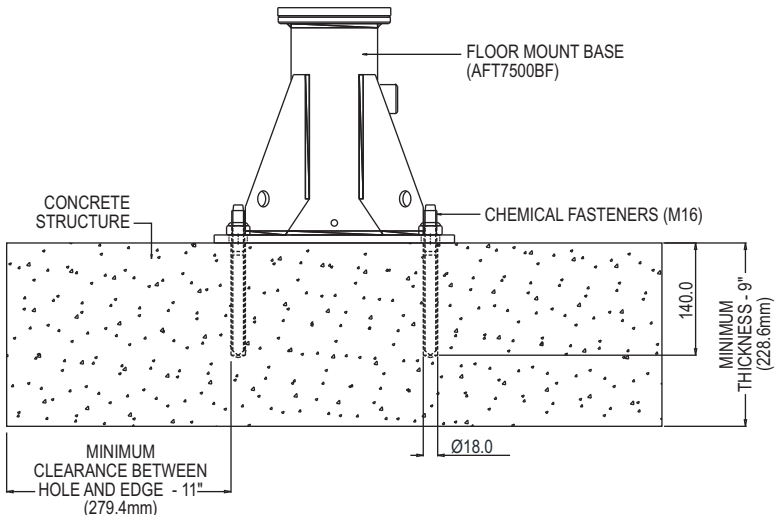
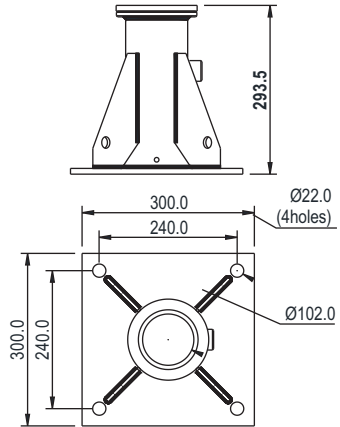

WARNING : Failure to follow User Instructions and Installation instructions may lead to severe injury and/or death.

Wall Mount Base (AFT7500BW) are designed for mounting to concrete or steel structures.

Structure : The receiving structure must be able to withstand stresses equivalent to 22.1 MPa or 22.1N/mm². The fasteners/structural anchors must be strong enough to handle this strain. Refer Fastener manufactures UIM for stainless steel/High tensile M16 fasteners.

Installation :

- Thickness of concrete block should be minimum 9"(228.6mm)
- All receiving Structures should be verified by a qualified structural Engineer.
- Base Installation must be approved to local regulations by a qualified engineer.
- Refer to Fastener Manufacturer to ensure the correct fasteners are used.
- If the Base material does not meet the minimum requires to install, then reinforcement is required. Refer to a qualified engineer.
- Drill holes should have a minimum clearance of 11"(279.4mm) from all available edges
- If unsure, refer to a qualified engineer to recommend the location to mount the Floor mount base to the structure.
- Drill 4 holes using the base as a guide
- Install the recommended M16 fasteners and mount the base then tighten the bolts.
- Can also be installed on cantilever of concrete beam by sandwitching two plates on concrete structure
- Suitable M16 fasteners should be used for fixing the brackets to the structure.

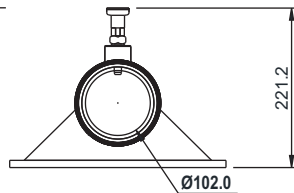
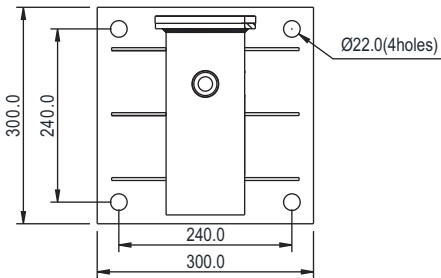
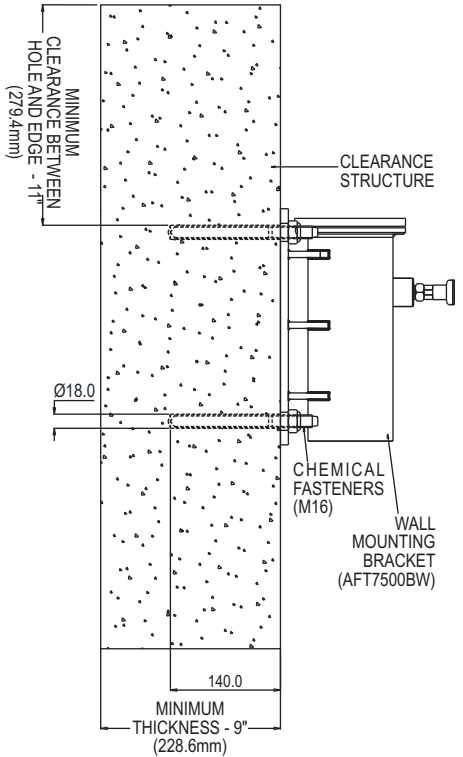

WARNING : Failure to follow User Instructions and Installation instructions may lead to severe injury and/or death.

The Extreme Davit (AFT7500) :

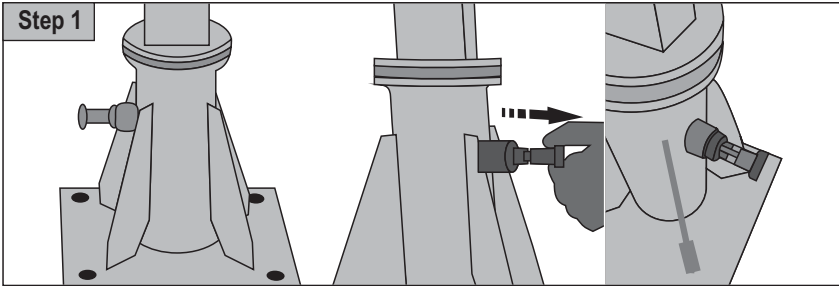

On the mounted floor mounting bracket / wall mounting bracket first pull the inserted Locking pin outwards, turn them 90° and let it go again. That secures them against springing back inwards.

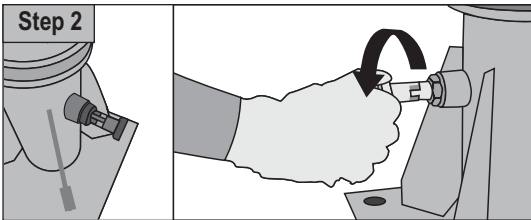

Insert the column into the floor mounting bracket. Pull the pin and rotate it at 90°, this brings back the pin to its initial position.

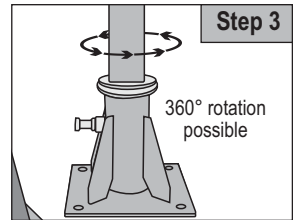

At the bottom, round part of the lower arm of the column, there are 8 holes for the stop bolts, which allow the Extreme Davit to be locked at intervals of 45°. If unlocked, the Extreme Davit is free to rotate at 360°.

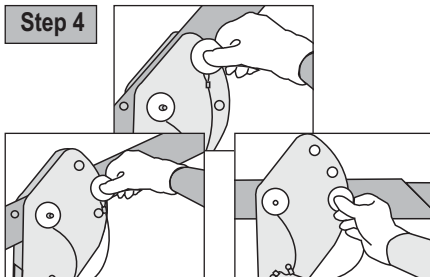

Unlock the locking pin by pressing on the pin and pulling it out. Now swing the extension arm of the Extreme Davit into desired Position 1, 2 or 3 as preferred and secure it again by pushing the lock pin back in.

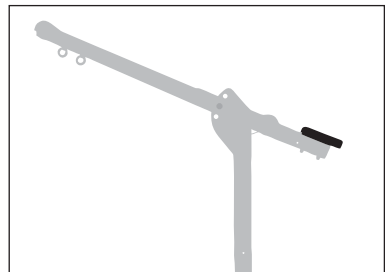

Extreme Davit is now ready for its basic function.

10. INSTRUCTIONS FOR INSTALLATION OF WINCH AFT730020 ON EXTREME STAINLESS DAVIT (AFT7500)

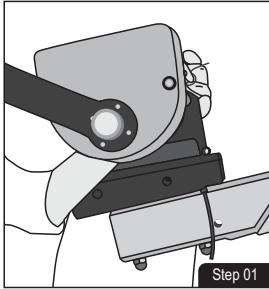

Locate the Extreme Stainless Davit arm that has pre-installed mounting bracket for installing the winch. Place the winch on the mounting bracket of the Extreme Stainless Davit arm and insert the guiding pin into the slot.

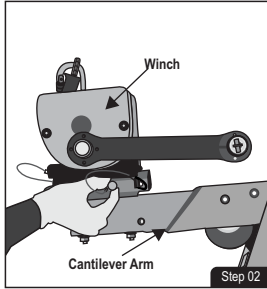

Use solid pin for locking the winch on pre-installed mounting bracket of Extreme Stainless Davit Arm.

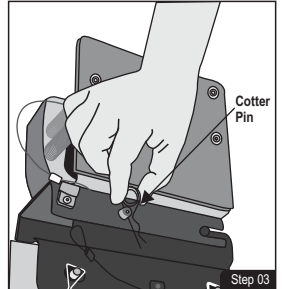

Lock the solid pin on mounting brackets using cotter pin.

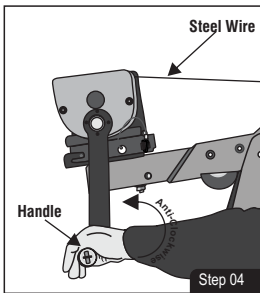

Pull out the handle of the winch outside and rotate it anti-clockwise to release the steel wire. Keep on releasing till you are able to release enough length such that it can pass over the pulleys of the Extreme Stainless Davit and get suspended vertically downwards.

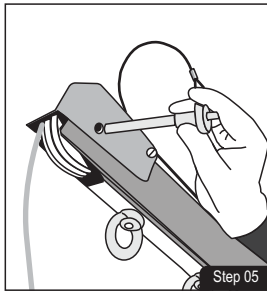

Pass the wire to the pulley as required and insert the pin back to lock the Rope Movement. Extreme Stainless Davit is now ready to use.

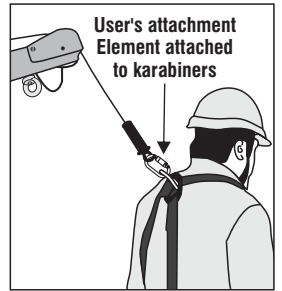

11. INSTRUCTIONS FOR INSTALLATION OF RESCUE RETRIEVAL BLOCK (AFS510020R/AFS510030R) ON EXTREME DAVIT (AFT7500)

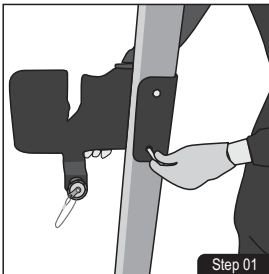

Fix the Mounting Bracket for installing the Rescue Retrieval Block.

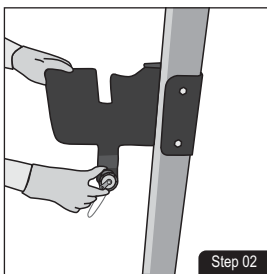

Release the knob of the Mounting Bracket to place the Block.

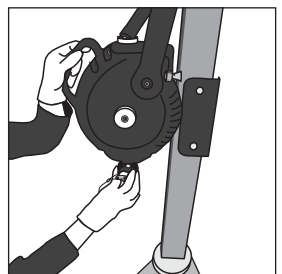

Once the Block is placed, tighten the knob to fix it.

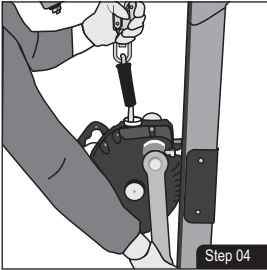

Release the webbing of the Block to pass it along the Extreme Davit's Arm.

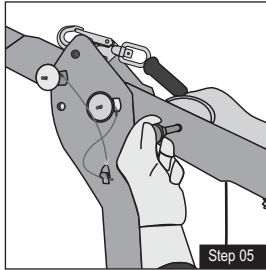

Unlock the pin of the pulley to pass along the Hook of the Block from the Extreme Davit's Arm & then insert the pin to lock it. Now the hook is ready to be used as an Attachment Point.

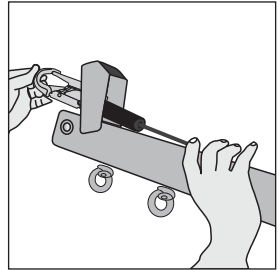

12. OPTIONAL ACCESSORIES:

- KStrong RETRACTABLE FALL ARRESTER rated capacity 140 kg / 1 person
- KStrong Winch (AFT730020) rated lift capacity 140 kg / 1 person
- Kstrong Rescue Retrieval Block (AFS 510020R) rated lift capacity 140 kg / 1 person

13. ASSEMBLY OF OPTIONAL EQUIPMENT:

- KStrong Brute Winch is mounted on the top of the cantilever attaching to the existing multi bracket.

14. LIMITATIONS :

- The apparatus **MUST** only be operated by appropriately trained and skilled persons. Users of this equipment should not suffer from any kind of health impairment! (e.g. alcohol, drug, medication or circulation problems)
- The optional KStrong Retractable fall arrester is intended for use at temperatures between - 30 and +50 °C, in accordance with EN 360.
- The permissible load on the fall protection apparatus corresponds to EN 795 for securing 1 person of Max. 140Kgs.
- No modifications or additions should be made in the system.
- **Following Conditions May Be Hazardous & May Affect The Performance Of The Extreme Davit:**
 - Extreme temperature.
 - Trailing or looping of Lanyards over sharp edges.
 - Extreme acidic or basic environment.
 - Abrasive or sharp edge structures which can damage the equipment.
 - Grease, Oil, and Harmful chemical reagents.
 - Direct exposure to rain and moisture.
 - Ultra-Violet radiation.
- This fall protection apparatus compliant with EN 795:2012 Type B is tested for securing maximum 1 Person against falling. In conjunction with additionally required EN 361 compliant safety harnesses, EN 360 compliant KStrong Retractable fall arrester and EN 1496 compliant KStrong Winch, it serves for the safety of persons performing work that involves a risk of falling. The fall protection apparatus and Retractable fall arrester must only be used as intended.
- Use karabiner conforming to EN 362 for connecting to the anchor points.
- Failure to observe the instructions for use can, present a danger to life. In the event of a fall, hanging in the harness for any longer than 20 minutes must be avoided (risk of suspension trauma orthostatic shock).
- An optional KStrong Retractable fall arrester can only protect one person while in use.
- The apparatus should be arranged as close to perpendicular over the head of the person to be secured in order to prevent swinging in the event of a fall.
- If the cable breaks or becomes kinked or roughened, the optional KStrong fall arrester must be sent in to the service workshop for the cable to be replaced.
- It is essential for the safety of the user that if the product is resold outside the original country of destination, the reseller shall provide instruction for use, for maintenance, for periodic examination and for repair in the language of the country in which product is to be used.

15. **REPAIR:** If the product becomes damaged, it will NOT provide the optimum level of protection, and therefore should be immediately removed from service. It needs to be inspected to see if it is replaced or repaired. Never use the damaged product. Repair is only permitted by the manufacturer or a nominated repair centre or individual approved by the manufacturer.
16. **INSTRUCTIONS FOR CLEANING:**
 - In case of minor soiling, wipe the equipment with cotton cloth or soft brush. Do not use any abrasive material.
 - Store in cool dry place, preferably away from moisture, direct sunlight, extra acidic or basic conditions, and sharp edges.
17. **INSTRUCTIONS FOR MAINTENANCE:** According to the PPE Directive BS8437:2005, the equipment MUST be sent for an overhaul for function and maintenance to the KStrong authorized center once in every 12 months.
18. **WARNING:**
 - DO NOT ALTER OR MISUSE THE EQUIPMENT. It is prohibited to make any alterations or additions to the equipment without the manufacturer prior written consent, and any repair shall only be carried out in accordance with manufacturers procedures.
 - Withdraw from use immediately if there is any doubt about its safe condition or if it has already arrested a fall.
 - Use of equipment in unintended applications may result in serious injury or death. Maximum 1 attachment per connection point.

LABELS

KSTRONG®
UNRIVALED SAFETY.
EXTREME DAVIT
AFT7500

(ii)

(iii)

(iv)

(v)

UID :
Date of mfg. :

Adjustable height
Upper setting : 2.3m
Middle setting : 1.9m
Lower setting : 1.5m

Rotation possible 360°

Load capacity : 200 KGS
Strength : MIN. 13 kN

WARNING
Please Read User's Manual
Carefully Before Using the
Product

CE 0598
EN 795:2012 Type B

EN 795:2012
Ex h Iic T6 Gb
EN 80079-36:2016
EN 80079-37:2016

KStrong Asia Pte Ltd
33A Chander Road, Singapore 219539
KStrong.com Made In India

(i)

KSTRONG®
UNRIVALED SAFETY.
FLOOR MOUNTING BRACKET
AFT7500BF

UID :
Date of mfg. :

EN 795:2012 Type A

KStrong Asia Pte Ltd
33A Chander Road, Singapore 219539
KStrong.com Made In India

KSTRONG®
UNRIVALED SAFETY.
WALL MOUNTING BRACKET
AFT7500BW

UID :
Date of mfg. :

EN 795:2012 Type A

KStrong Asia Pte Ltd
33A Chander Road, Singapore 219539
KStrong.com Made In India

LABEL EXPLANATION:

- (i) The CE mark showing that product meets the requirements of the PPE Regulation (EU) 2016/425.
- (ii) Identification of the manufacturer.
- (iii) Type of product code.
- (iv) UID for traceability of product.
- (v) Month/ Year of Manufacture.

Certification Body :

SATRA Technology Europe Ltd, Bracetown Business Park, Clonee, Dublin D15 YN2P Ireland (Notified Body 2777)

Ongoing Assessment Body:

SGS Fimko Oy, Takomotie 8, FI-00380 Helsinki, Finland (Notified Body 0598)

For EU Declaration, please visit <https://kstrong.com/asia/eu-declaration-form/>



KStrong Asia Pte Ltd

33A Chander Road, Singapore 219539
Contact Email: customercare@kstrong.com

www.kstrong.com

USA

South America

ASIA
