



**AFF4000 & AFF4000LS
HORIZONTAL FXLINE
LIFE LINE SYSTEM
ON CONCRETE
STRUCTURES**

**USER INSTRUCTION MANUAL
&
TECHNICAL INFORMATION**

**Disclaimer**

The information provided in this User Instruction is based on the technical data that KStrong obtained under laboratory conditions and believes to be reliable. KStrong does not guarantee results and takes no liability or obligation in connection with this information. Since conditions of end-use are beyond our control, it is the user's responsibility to determine the hazard levels and the use of proper personal protective equipment. Persons having technical expertise should undertake evaluation under their specific end-use conditions, at their discretion and risk. Please ensure that this information is only to check that the product selected is suitable for the intended use. Any product that is damaged, torn, worn, or punctured should be discontinued from usage immediately.

CONTENTS

Know Your System	01
Standards	02
Instruction Guide	03
Job Safety Analysis	04
AFF4000 & AFF4000LS FALL ARREST SYSTEM COMPONENTS	
Component Chart	07
AFF4000 (Floor/Wall/ Ceiling Mounted)	08
AFF4000LS	09
Universal Extremity Plate and Shock Absorber	10
Shock Absorber	11
Tensioner	12
Wire Rope	13
Traveler	14
Intermediate	15
Corner Bracket	16
Cable Termination	17
Inspection Plate: AFF115101H	18
Fastening in Concrete Structures and Universal Extremity Anchor Plate	19
Intermediate Bracket	20
Corner Post	21
Fastening in Concrete Structure Using Fixed Anchor Posts	21
Installation of the system and Cable Termination and Shock Absorber (Ref. AFF4000 Over Head, Wall & Ceiling Mounted)	22-23
Tensioner and Intermediate(Ref. AFF4000 Roof Mounted, Wall & Ceiling Mounted)	24
Traveler (Ref. AFF4000 Over Head, Wall & Ceiling Mounted)	25
PRE- USE CHECKS & PRECAUTIONS	
Post Installation Inspection	26
Precautions While Using the System	27
INSPECTION USE AND MAINTENANCE	
PPE Inspection and Revalidation	28
Warranty	29
Tools Required	30
Proof Loading	32

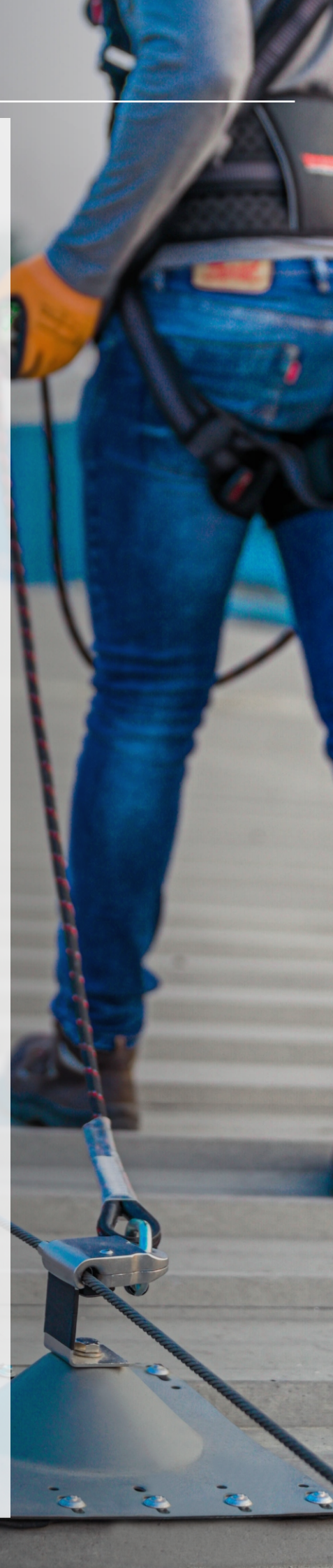

Know Your System

AFF4000 Horizontal Lifeline System on Concrete Structure

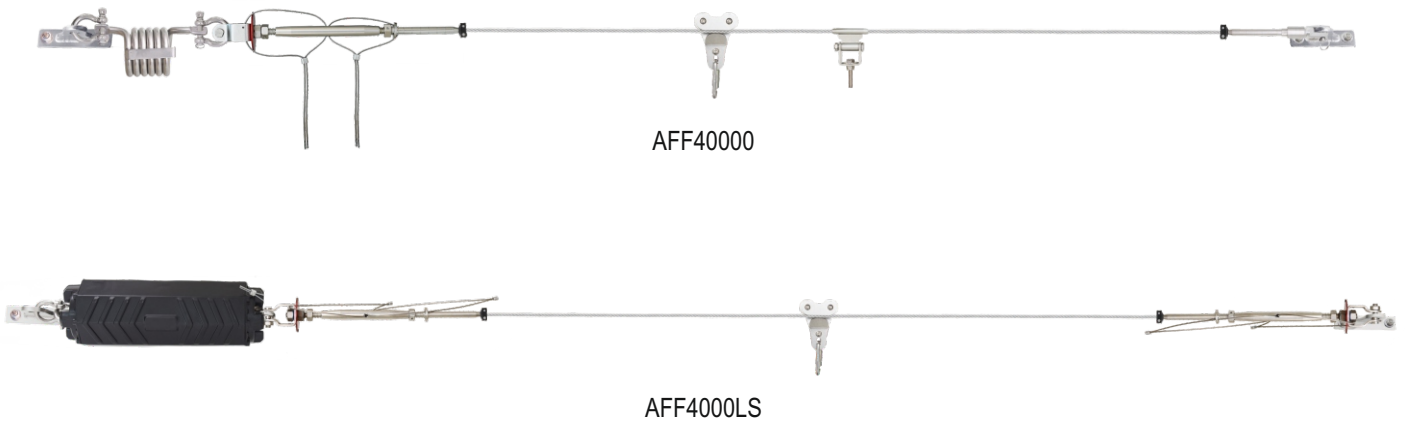

The AFF4000 Cable Line Fall Arrest System is designed for commercial buildings and industrial structures of all types. Our engineered systems cover all your working at heights requirements for maintenance, cleaning, access, wash bays and inspections.

KStrong has developed two types of Horizontal Lifeline systems to suit different needs, our standard AFF4000 and AFF4000LS Long Span Horizontal Lifeline system designed for single spans up to 35m.

The Fixed Cable Line Fall Arrest System is an integrated solution to arrest the fall of a user who constantly works on any building/ structure that has an element of a potential fall and where your only fall arrest connection point is above your head or on the side of a building or structure.

This system allows you to walk along a fall edge for a continued distance while staying connected in fall arrest. Suitable for 4 users.







Safety, simplicity, and durability are some key words to explain the advantages of this system.

This system is made of stainless steel components, wire cable and is maintained in the rigid position by the use of two mounting brackets-one at the start and one at the end.

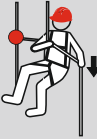
The AFF4000 Cable Line Fall Arrest System has been rigorously tested and manufactured in accordance with EN795:2012 Type C & TS 16415:2013 and AS/NZS 5532:2013 Standards, ensuring you have quality and guarantee of any system installed onto your asset.

HORIZONTAL LIFELINE SYSTEM

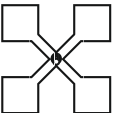
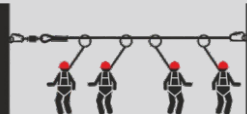
Standards

Standards		Description
EN 353-1		Guided type fall arresters including a rigid anchor line
EN 353-2		Guided type fall arresters including a flexible anchor line
EN 795 Type A		Anchor device requiring the fixing of one or more structural anchors
EN 795 Type B		Anchor device not requiring the fixing of one or more structural anchors
EN 795 Type C		Anchor devices using a horizontal flexible anchor line
EN 795 Type D		Anchor devices using a horizontal rigid anchor line
EN 795 Type E		Deadweight anchoring device
CEN/TS 16415:2013		Personal fall protection equipment - Anchor devices - recommendations for anchor devices for use by more than one person simultaneously
 II 2G Ex h IIc T6 Gb EN 80079-36:2016 EN 80079-37:2016		The ATEX directives are two EU directives describing the minimum safety requirements for workplaces and equipment used in explosive atmospheres

Must be Read Prior to Use

- Prior to use, ensure all operating procedures have been read and properly understood.
- This fall arrest system is only to be used by competent persons who have experience and training in the safe use of the system and associated equipment.
- Ensure all local workplace OH&S requirements are identified and understood.
- A risk assessment with a safe work method procedure must be completed and approved by management prior to work commencing.
- The systems requires periodic inspection and maintenance by the manufacturer or their authorized representative as per EN365 of the PPE Regulation 2016.
- The system **MUST NOT** be used if the service date is overdue.
- A rescue plan must be formulated and ready for implementation prior to using any fall arrest system.
- Authorisation to access any risk area must be obtained from the person in control of the workplace.
- Only approved full body harness, lanyard and PPE certified either EN, ANSI or AS/NZS Standards are to be used with this system.
- Visually inspect the system for damage prior to use. The system must not be used if there is any deterioration or deformation of components or the structure to which the system is attached.
- If the safety system is damaged or has arrested a fall, discontinue use until it has been fully inspected and recertified by the manufacturer or their authorized representative.
- Ensure all fixings, fittings and components are securely attached. Any tightening, adjustment or replacement of components must be carried out by a competent person.
- Users must not be allowed to work alone in fall arrest situations in case emergency rescue assistance or first aid is required.
- All applicable EN Standards, Local OHS Acts & Regulations, and Codes of Practice & Guidelines must be read and obeyed when using this safety system.

Instructions for Periodic Examinations

- As per EN 365 of PPE Regulation 2016, it is necessary to carry out regular periodic examinations. The safety of the users depends upon the continued efficiency and durability of the equipment.
- The personal protective equipment shall be examined at least every 12 months.
- For corrosive/harsh environments, once every 6 months (more frequent inspection may be required).
- The periodic examination can only be carried out by the manufacturer or their authorized representative.
- The comments should be included in the check card of the equipment. After the periodic examination, the next due date for periodic examination will be determined.
- During periodic inspection, it is necessary to check the legibility of the equipment marking.
- To check metals for sharp edge, burs, corrosion, bent profile distortion and opening & closing or such mechanisms for which that is intended for.

Remove from Service

- In case that it has been used to arrest a fall, the equipment must be withdrawn from use.
- Labels have been removed, are missing or illegible
- Excessive abrasive wear has occurred
- Broken fibres, tears, cuts, snags and splinters are present
- Deterioration or stretching has occurred
- Parts and mechanisms are not moving freely or are corroded
- There is excessive contamination not removed by approved cleaning methods

HORIZONTAL LIFELINE SYSTEM

Job Safety Analysis

Before commencing the job, it is recommended that the service technician / installer completes a JSA form, to identify hazards at site and to decide the correct PPE they need to mitigate the hazard. Refer to the example below.

Section 1 Job details					
JSA title	Project name		Work order or PID No.		
	Principal contractor				
Location / address				Date/s of activity	
Prepared by		Date prepared		Signature	

Permits required				Isolations required	
<input type="checkbox"/> Confined Space	<input type="checkbox"/> High risk work rescue plan	<input type="checkbox"/> High voltage access	<input type="checkbox"/> Roof Access	<input type="checkbox"/> Mechanical	<input type="checkbox"/> Hydraulic
<input type="checkbox"/> Work at height	<input type="checkbox"/> Excavation and trenching	<input type="checkbox"/> Energized work	<input type="checkbox"/> Other (please specify)	<input type="checkbox"/> Electrical	<input type="checkbox"/> Pneumatic
<input type="checkbox"/> Penetrating	<input type="checkbox"/> Grid mesh, flooring and guard rail removal	<input type="checkbox"/> Hot work		Site access required	<input type="checkbox"/> YES <input type="checkbox"/> NO

Section 2-Common hazards (Each hazard identified below must be assessed)

Chemicals/hazardous substances		High-risk activities	
Name of chemicals or hazardous substance <input type="checkbox"/> SDS available		<input type="checkbox"/> Confined space	<input type="checkbox"/> Work at heights
		<input type="checkbox"/> Hot Work	<input type="checkbox"/> Excavation, trenching or penetrations
Energy sources		<input type="checkbox"/> Construction work	<input type="checkbox"/> Scaffolding
<input type="checkbox"/> Electricity	<input type="checkbox"/> Pressure	<input type="checkbox"/> Demolition	<input type="checkbox"/> Structural alterations
<input type="checkbox"/> Gas / Fuel	<input type="checkbox"/> Water	Work location	
Plant and equipment		<input type="checkbox"/> Sun	<input type="checkbox"/> Working over, in or near water
<input type="checkbox"/> Fixed Plant	<input type="checkbox"/> Mobile Plant	<input type="checkbox"/> Plants, Animals or Insects	<input type="checkbox"/> Contaminated / Flammable atmosphere
<input type="checkbox"/> Vehicles / boats	<input type="checkbox"/> Hand Tools	<input type="checkbox"/> Slips, trips and falls	<input type="checkbox"/> Work occurring in other areas
Manual tasks		<input type="checkbox"/> Biological hazards	<input type="checkbox"/> Fire
<input type="checkbox"/> Repetitive tasks	<input type="checkbox"/> Heavy Lifting	People	
<input type="checkbox"/> Awkward posture	<input type="checkbox"/> Sustained posture	<input type="checkbox"/> Remote or isolated work	<input type="checkbox"/> Contractors
Facilities / built environment		<input type="checkbox"/> Fatigue	<input type="checkbox"/> Visitors / land owners / public
<input type="checkbox"/> Buildings and fixtures	<input type="checkbox"/> On/in or adjacent to roadways	<input type="checkbox"/> Competency or training required	<input type="checkbox"/> License required
<input type="checkbox"/> Open pits, trenches or tunnels	<input type="checkbox"/> Asbestos/ lead	Environment and water quality	
<input type="checkbox"/> Overhead objects or services	<input type="checkbox"/> Underground objects or services	<input type="checkbox"/> Erosion & sediment control	<input type="checkbox"/> Waste/ discharge
<input type="checkbox"/> Lighting	<input type="checkbox"/> Noise	<input type="checkbox"/> Emissions (or air pollution)	<input type="checkbox"/> Flora/ fauna/ weed management
<input type="checkbox"/> On or near pressurized gas distribution mains or piping	<input type="checkbox"/> On or near chemical. fuel or refrigerant lines	<input type="checkbox"/> Release to drains/waterways	<input type="checkbox"/> Water quality

HORIZONTAL LIFELINE SYSTEM

AFF4000 Overhead, Ceiling and Wall Mount Fall Arrest System Components

This system is made of stainless steel components, wire cable and is maintained in the rigid position by the use of two mounting brackets, installed at each end.

The AFF4000 Fall Arrest System has been rigorously tested and manufactured in accordance with EN795:2012 Type C & TS 16415:2013 Standards.

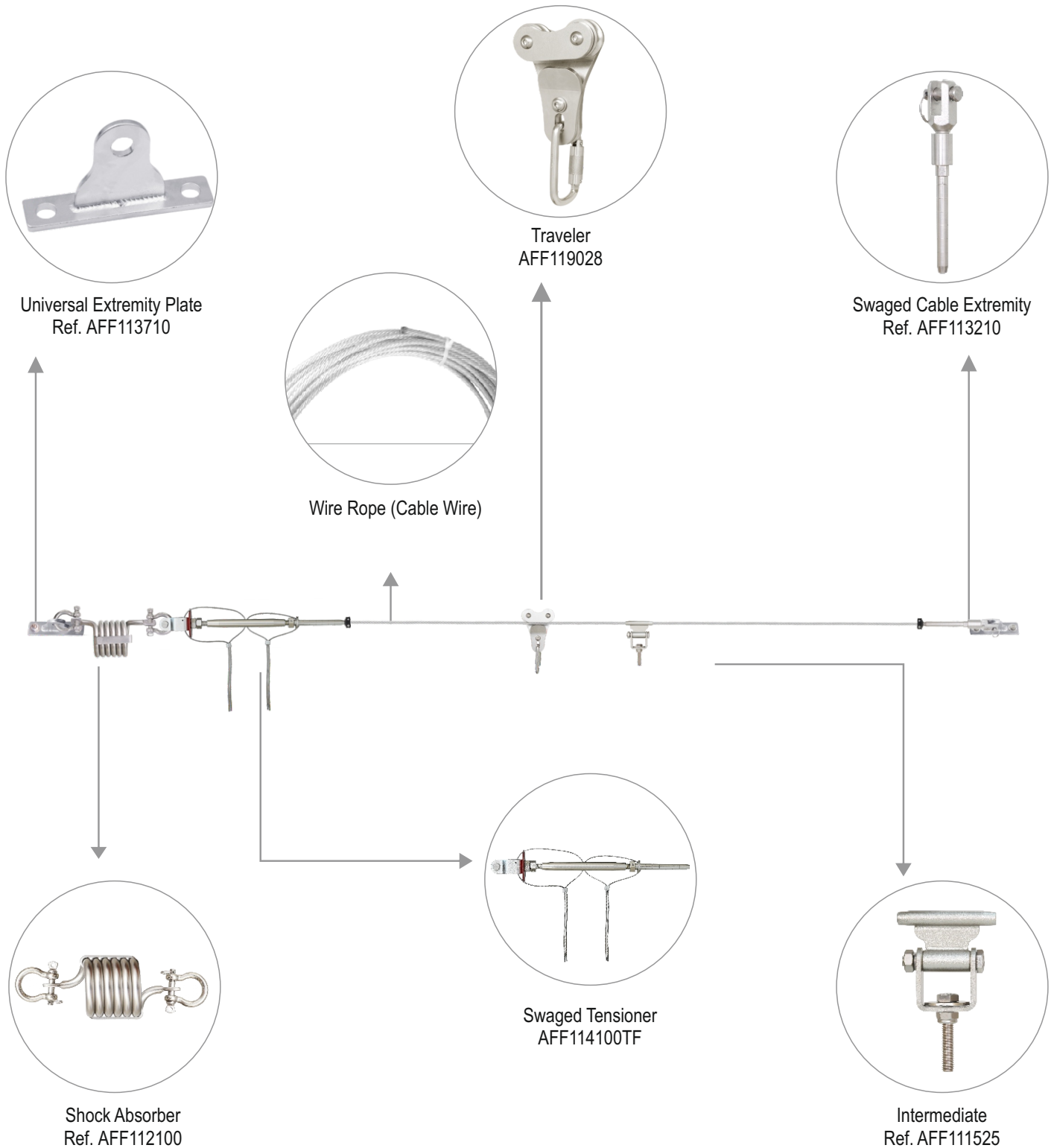

HORIZONTAL LIFELINE SYSTEM

Component Chart

The chart below shows all the components of the AFF4000 Horizontal Lifeline System on concrete structure with their appropriate product codes and quantity required in a system.

AFF4000 OVER HEAD, CEILING & WALL MOUNT TECHNICAL SNAPSHOT

Sr. No.	Component	Code	Qty. Required
1	Universal Extremity Plate	AFF113710	2 Nos.
2	Traveler c/w Karabiner	AFF119028	1 No.
3	Swaged Cable Extremity	AFF113210	1 No.
4	Wire Rope (8mm 7x19 Cable Wire)	AFF518XXX(S)	As per length
5	Shock Absorber	AFF112100	1 No.
6	Swaged Tensioner	AFF114100TF	1 No.
7	Intermediate 220 Deg Swivel Bracket	AFF111525	1 No.
8	Intermediate	AFF111510	1 No. (optional)
9	Double Tandem Pulley Small with SS Sheaves	AFX206009	1 No. (optional)
10	Traveler	AFF119100	1 No. (optional)

OPTIONAL



AFF111510
Intermediate



AFX206009 Double Tandem
Pulley Small with SS Sheaves



AFF119025 Traveler

HORIZONTAL LIFELINE SYSTEM

Overhead Long Span Mounting

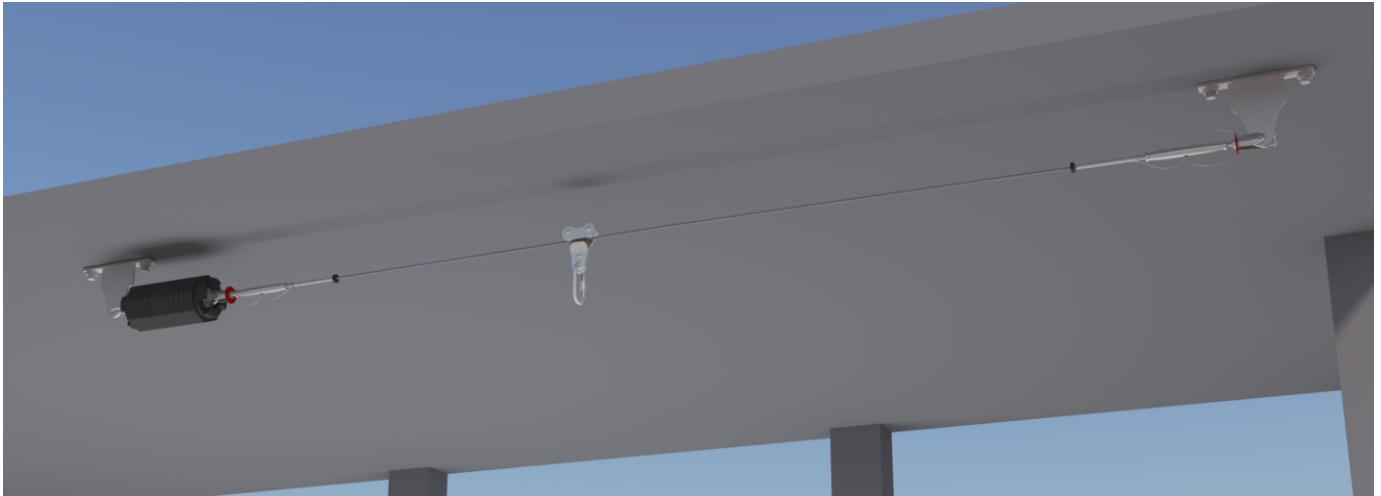

Wall Mounted

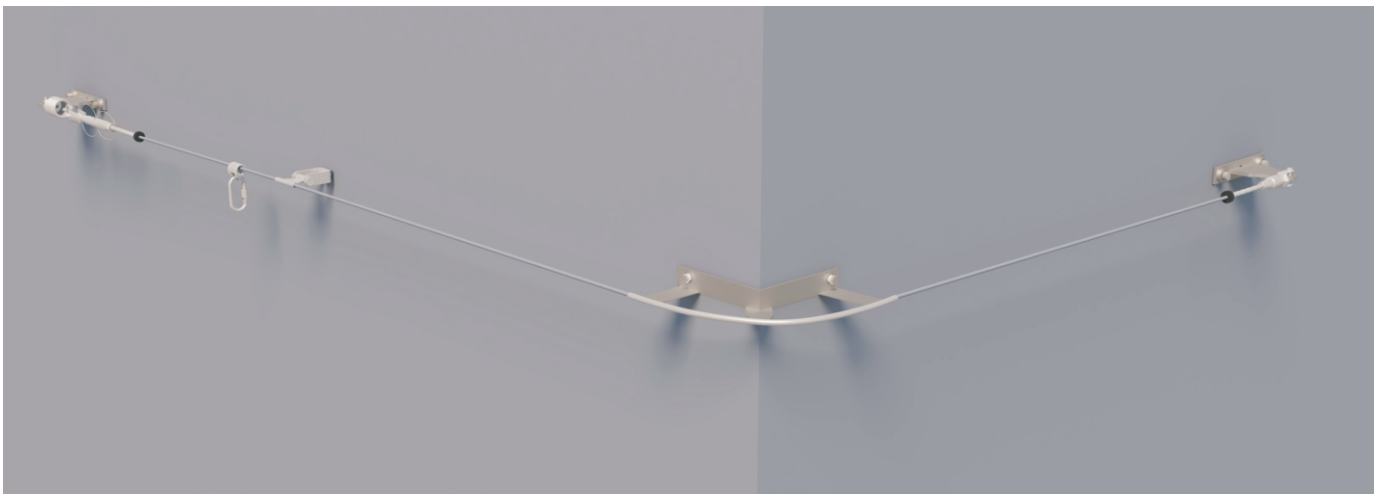

Ceiling Mounted



HORIZONTAL LIFELINE SYSTEM

AFF4000LS 18kN Horizontal Lifeline System Designed for Single Spans up to 35 meters

It has been designed to start to deploy when 18kN of force has been applied, allowing the line to be pretensioned at a higher force. The result is very low deflection in cable and very low fall arrest distance.

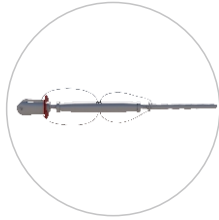

Swaged Tensioner
AFF114113



Wire Rope (Cable Wire)
AFF518119XXS



Universal Extremity Plate
AFF113710

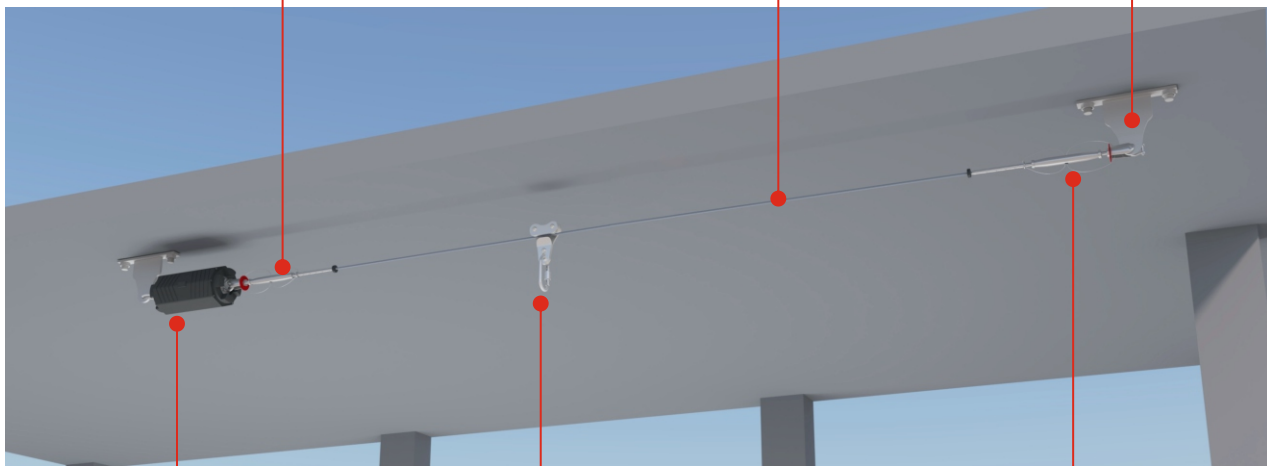

Shock Absorber
AFF114112



Traveler
AFF119028

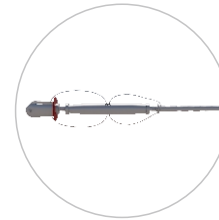

Swaged Tensioner
AFF114113

AFF4000LS 18kN LONG SPAN

AFF4000LS TECHNICAL SNAPSHOT

Product Name	Component	Features	Qty. Required
Shock Absorber 18kN	AFF114112	Material: Stainless Steel 316 & Aluminum	1 No.
Long Span Swaged Tensioners	AFF114113	Regulates cable tension up to 5kN Material: Stainless Steel 316 Feature: Swage termination	2 Nos.
Wire Rope (8mm 1x19 Cable Wire)	AFF518119XXS	Material: Stainless Steel 316 Diameter: 8mm Construction: 1x19 High breaking strength and low elongation	As per length
Traveler	AFF119100	Material: Stainless Steel 316 Trolley wheels reduced friction	1 No.
Universal Extremity Plate	AFF113710	Material: Stainless Steel 316	2 Nos.
Inspection Plate	AFF115100H	For identification traceability and maintenance of implementation records.	1 No.

Universal Extremity Plate

Stainless Steel Universal Extremity Plate is used to create an anchor point at the ends of the lifeline.



TECHNICAL SNAPSHOT

Universal Extremity Plate	AFF113710
Design	Universal Extremity for Horizontal Lifeline
Application	Anchorage point for Horizontal Lifelines with over head application. For steel structures M12x50. For concrete M12X80 (Refer Hilti HSV guide)
Material	Stainless Steel Grade 316
MBS	36kN
Weight	0.70 kg
Conforms to	EN 795:2012 Type A and TS16415, AS/NZS 5532:2013

Shock Absorber

The Shock Absorber reduces the impact of the fall on the user as well as on the structure. The shock absorber also has a tension indicator at one end to help the installer know how much tension is to be given to the line after the installation.



TECHNICAL SNAPSHOT

Shock Absorber	AFF112100	AFF114112
Design	Multiple Users	Multiple Users
Application	Spring type shock absorber. It reduces the impact force in the event of a fall or overloading on the system.	The shock absorber deploys at 18kN, allowing the lifeline to be pretensioned up to 5kN. It reduces the impact force in the event of a fall or overloading on the system.
Minimum Activation Force	MAF of energy absorber is 1kN	MAF of energy absorber is 18kN
Length	258mm	461mm
Material	Shock Absorber 316 Stainless Steel	Shock Absorber 316 Stainless Steel with PVC protective covering, D-Shackle 316 Stainless Steel
MBS	25kN	40kN
Weight	1.5 kgs	4.5 kgs
Conforms to	EN 795:2012 Type C and TS16415, AS/NZS 5532:2013	EN 795:2012 Type C and TS16415, AS/NZS 5532:2013

HORIZONTAL LIFELINE SYSTEM

Tensioner

The Tensioner is attached to the shock absorber using stainless steel nut bolts and has a swageless termination at one end for the wire rope. Once the lifeline is installed, the tensioner is tightened by inserting a rod in the hole and rotating it.

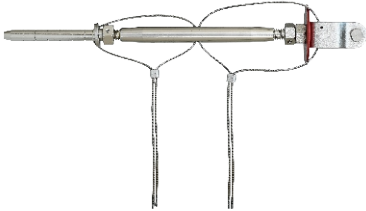

Swaged Tensioner
AFF114113 (Used for
Long Span only)

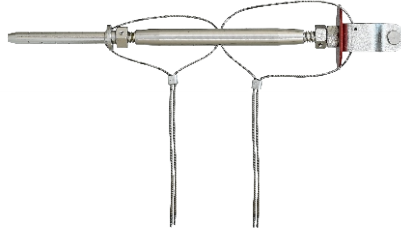

Swaged Tensioner
AFF114100TF

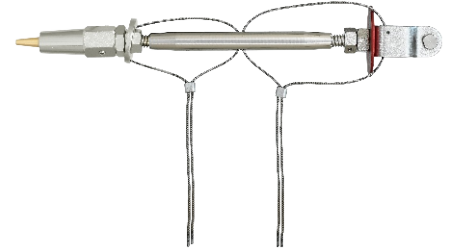

Swageless Tensioner
AFF114100(SL)

TECHNICAL SNAPSHOT

Tensioner	AFF114113 (Long Span only)	AFF114100TF	AFF114100(SL)
Design	It has one side swage and one side eye to fix in the shock absorber	It has one side swage and one side eye to fix in the shock absorber	It has one side swageless extremity and one side eye to fix in the shock absorber
Application	The tension device is an interconnection between the cable and shock absorber with cable length adjustment feature, providing up to 5kN of pretension.	The tension device is an interconnection between the cable and shock absorber with cable length adjustment feature.	The tension device is an interconnection between the cable and shock absorber with cable length adjustment feature.
Size	14mm	14mm	14mm
Material	Stainless Steel Grade 316	Stainless Steel Grade 316	Stainless Steel Grade 316
Weight	1.450kg	1kg	1kg
MBS	35kN	35kN	35kN
Conforms to	EN 795:2012 Type C and TS16415 & AS/NZS 5532:2013	EN 795:2012 Type C and TS16415 & AS/NZS 5532:2013	EN 795:2012 Type C and TS16415 & AS/NZS 5532:2013

HORIZONTAL LIFELINE SYSTEM

Wire Rope

Stainless Steel Cable



WIRE

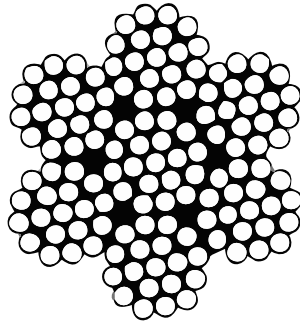

7 STRANDS
OF 19 WIRES

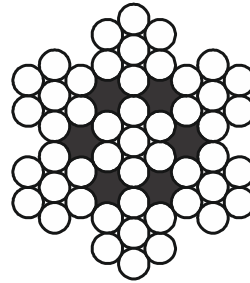

7 STRANDS
OF 7 WIRES

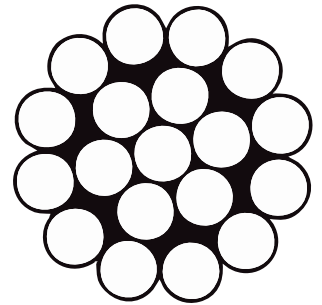

1 STRANDS
OF 19 WIRES



8MM WIRE CABLE

TECHNICAL SNAPSHOT

Wire Rope	AFF518XXX(S)	AFF5187X7XXXS	AFF518119XXXS
Design	7X19	7X7	1X19
Application	Stainless steel cable for horizontal and vertical life line systems	Stainless steel cable for horizontal and vertical life line systems	Stainless steel cable for horizontal and vertical life line systems
Size	8mm	8mm	8mm
Material	Stainless Steel Grade 316	Stainless Steel Grade 316	Stainless Steel Grade 316
MBS	39kN	39kN	44kN
Weight	0.24 kg per meter	0.30 kg per meter	0.34 kg per meter
Conforms to	EN 795:2012 Type C and TS16415 & AS/NZS 5532:2013	EN 795:2012 Type C and TS16415 & AS/NZS 5532:2013	EN 795:2012 Type C and TS16415 & AS/NZS 5532:2013

HORIZONTAL LIFELINE SYSTEM

Traveler

Simply connect a karabiner to the Traveler Body when using a lanyard, rope line or a fall arrestor with a full body harness allowing the user to freely travel along the length of the line.

The Traveler may be attached or detached from the line at any given point by two consecutive deliberate actions.



Traveler suitable for straight line and corners (supplied with Karabiner)



Traveler suitable for straight spans only (supplied with Karabiner)



Optional

Double Tandem Pulley Small with SS Sheaves suitable for single spans only

TECHNICAL SNAPSHOT

Traveler	AFF119025	AFF119028	AFX206009
Design	Openable Traveler with Karabiner suitable for all horizontal systems with corners with multiple spans	Wheel type openable traveler suitable for straight line systems with multi spans	Openable pulley type traveler suitable for single span
Application	The Traveler connects the user to the line with the help of lanyard / retractable block and moves smoothly without interruption along the length of the horizontal line		
Material	Traveler: Stainless Steel Grade 316 Karabiner: Stainless Steel Grade 316	Stainless Steel Grade 316 Karabiner: Karabiner: Stainless Steel Grade 316	Aluminum Alloy (Side Cover) Stainless Steel (Sheaves)
Weight	0.212 gms + 0.198 gms	1.142 gms + 0.198 gms	0.323 gms
MBS	25kN	25kN	40kN
Conforms to	EN 795:2012 Type B and TS16415 & AS/NZS 5532:2013	EN 795:2012 Type B and TS16415 & AS/NZS 5532:2013	EN 795:2012 Type B and TS16415 & AS/NZS 5532:2013

HORIZONTAL LIFELINE SYSTEM

Intermediate

The Intermediate brackets are used to divide a long line into multiple span, this reduces the sag on the line. The distance between two intermediate brackets may be between 5 meters and 15 meters depending on the receiving structure. For the long span systems, the maximum distance between two intermediates is 35 meters.



Intermediate



Intermediate 220 Deg Swivel

TECHNICAL SNAPSHOT

Intermediate	AFF111510	AFF111525
Design	Provided with adjustment holes to adjust the angle of line to three different angles.	Provided with adjustment up to 220°
Application	The intermediate is provided to hold the wire in position all along the length of the wire.	The Intermediate designed uniquely to hold & align the wire horizontal at different angles ranging upto 220°.
Material	Stainless Steel Grade 316	Stainless Steel Grade 316
MBS	15kN	15kN
Weight	0.58 kg	0.30 kg
Conforms to	EN 795 Type C:2012 and TS16415, AS/NZS 5532:2013	EN 795 Type C:2012 and TS16415, AS/NZS 5532:2013

Corner Bracket

Corner piece designed to be fixed on concrete floors or ceilings in conjunction with a horizontal lifeline (AFF4000).

Available in different variants depending upon the angle:



AFA935207 Corner Bracket

TECHNICAL SNAPSHOT

Corner Bracket	AFA935207(60) 60 degrees	AF935207(90) 90 Degrees	AFA935207(120) 120 Degrees
Design	Corner piece is designed to be installed when a bend or corner is required within the horizontal lifeline		
Application	Corner piece can be fixed on concrete floors or ceilings, metal beams directly or mounted to a post		
Material	Stainless Steel Grade 316	Stainless Steel Grade 316	Stainless Steel Grade 316
MBS	15kN	15kN	15kN
Weight	0.859 kg	0.809 kg	0.897 kg
Conforms to	EN 795:2012 Type C & TS 16415:2013 TYPE C		

HORIZONTAL LIFELINE SYSTEM

Cable Termination

The Stainless Steel Cable Extremity attaches directly to the end of the 8mm wire rope allowing a simple and easy connection to the extremity anchor. Simple and easy to install on the desired length of the cable. The extremity provides neat end connection eliminating any loose wires.

*** NOTE:** The swagless cable extremity is not suitable for Long Span systems. *



Cable Extremity Swageless



Swaged



TECHNICAL SNAPSHOT

Cable Termination	AFF512001	AFF113210
Design	Swageless	Swaged
Application	Cable extremity provides strong swage less end connections to the wire rope and completely eliminate the danger of any loose wire which may cause injury to the user working on the line. Not be used with Long Span Systems.	The swage provides a strong end connection. The swaging is done using a 130kN hydraulic swaging hand tool and hexlock dies at 6 positions.
Material	Stainless Steel Grade 316	Stainless Steel Grade 316
Weight	0.40 kg	0.50 kg
MBS	25kN	25kN
Conforms to	EN 795:2012 Type C and TS16415 & AS/NZS 5532:2013	EN 795:2012 Type C and TS16415 & AS/NZS 5532:2013

HORIZONTAL LIFELINE SYSTEM

Inspection Plate: AFF115101H

The Inspection Plate is installed on the tensioner side of the system for identification, traceability and maintenance of inspection records. At time of installation, the relevant details are recorded on the ID Tag. The next inspection dates are also recorded on the month and year on the back of the ID plate. The label is provided with a protective aluminum frame with a poly carbonate sheet for UV protection. It is installed on the pin ring of the tensioner. The label is equipped with a dynamic QR code and an RFID tag that are linked to the Compass inspection software.

 	
KStrong Horizontal Lifelines	
AFF4000	Roof Mount - EN 795:2012 TYPE C and CEN/TS 16415:2013
AFF4000	Wall, Floor and Ceiling Mount - EN795:2012 TYPE D
Date of Installation	 
No. of users	
UID	
Line No.	
customercare@kstrong.com www.kstrong.com/asia	



Engineering Calculation
Predict forces
extremity / deflection in cable



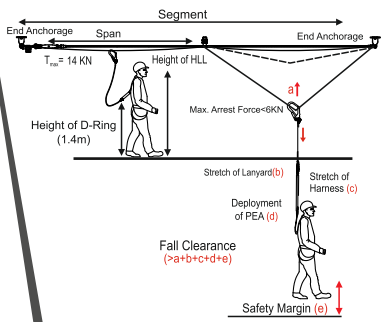



Segment
End Anchorage Span End Anchorage
 $T_{max} = 14 \text{ kN}$
Height of HLL
Max. Arrest Force=6kN
Height of D-Ring (1.4m)
Stretch of Lanyard (b)
Stretch of Harness (c)
Deployment of PEA (d)
Fall Clearance (>a+b+c+d+e)
Safety Margin (e)



 		
KStrong Horizontal Lifelines		
AFF4000	Roof Mount - EN 795:2012 TYPE C and CEN/TS 16415:2013	
AFF4000	Wall, Floor and Ceiling Mount - EN795:2012 TYPE D	
Date of Installation	 	
No. of users		
UID		K4000332
Line No.		
customercare@kstrong.com www.kstrong.com/asia		



Engineering Calculation
Predict forces
extremity / deflection in cable



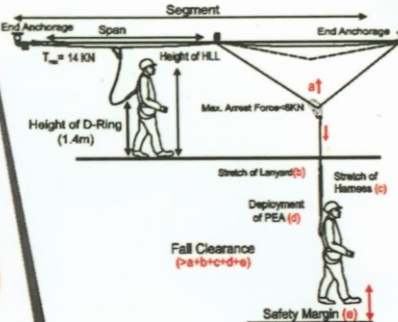

Segment
End Anchorage Span End Anchorage
 $T_{max} = 14 \text{ kN}$
Height of HLL
Max. Arrest Force=6kN
Height of D-Ring (1.4m)
Stretch of Lanyard (b)
Stretch of Harness (c)
Deployment of PEA (d)
Fall Clearance (>a+b+c+d+e)
Safety Margin (e)



Fastening to Concrete Structures:

- **Chemical Fastener M12:** Hilti HAS-E or Fischer FTR
- **Material of Chemical Anchor:** Stainless Steel 316
- **Concrete Adhesive:** HILTI HY 150, FISCHER FIS V360S or at least equivalent.

Fasteners and Tools

- Tools:**
- Dust blower
 - Hammer drill machine
 - Hammer drill 14 mm
 - Setting tool
 - Rebar locator

Note: Strictly follow the original instructions provided by the adhesive manufacturer!

Perform pull-out test to ensure that the concrete structure is able to withstand the required load

Setting Parameter					
Anchor Size	[mm]	M12	Minimum Slab Thickness	[mm]	100.0
Drill Size	[mm]	Ø14.0	Minimum Clearance from Edge	[mm]	200.0
Drill Depth	[mm]	80.0	Minimum stud length	[mm]	100.0

Universal Extremity Anchor Plate (AFF113710)

- Using the rebar locator, mark the position of the holes which are not obstructed by the rebar.
- Drill 2 nos. of hole Ø14mm in structural concrete 80mm in depth, following the distance between the 2 holes of the Extremity Anchor Plate. Concrete quality at least C20/25 (20MPa based on cylinder test and 25MPa based on cube test).
- Clean hole by blowing it out, using a dust blower.
- Insert the M12 Chemical Fasteners (not included) using a setting tool in accordance with the instructions for installation and use provided by the adhesive manufacturer.
- Check for firm seat.
- Use hex nuts and/or locks nut (not included) to attach and tighten the extremity plate.

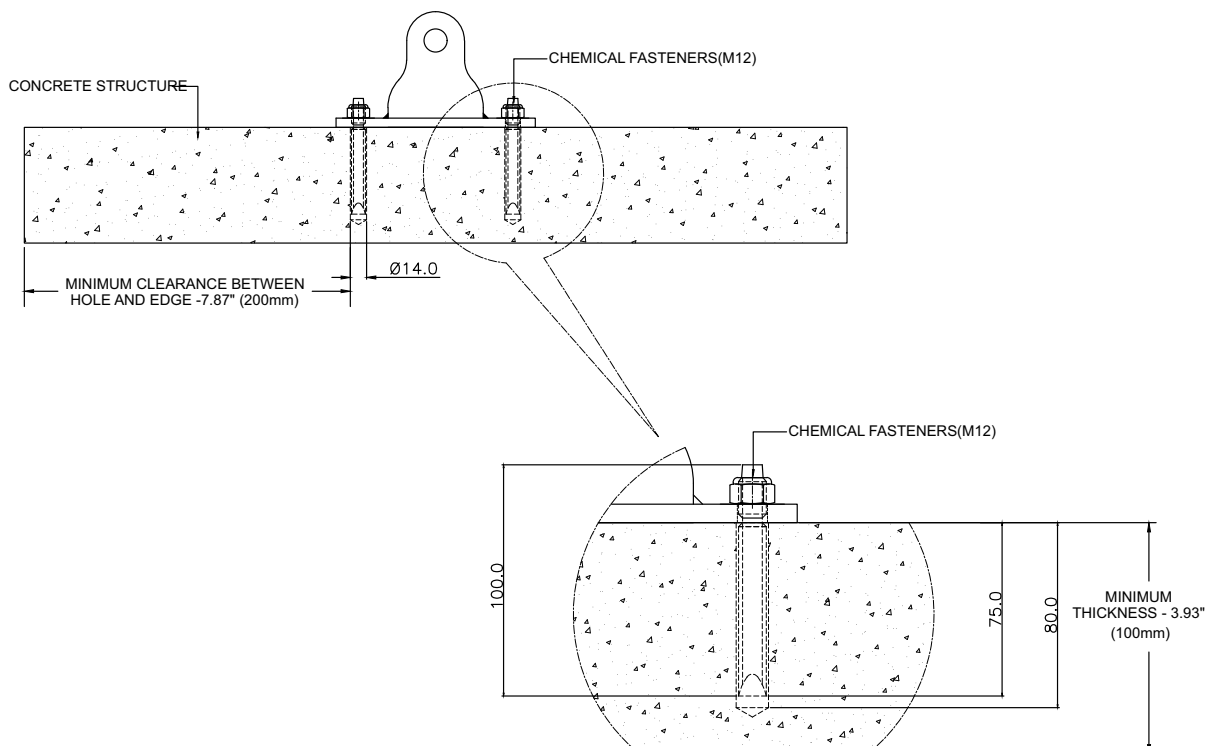

Intermediate Bracket (AFF111525)

- Using the rebar locator, mark the position of the holes which are not obstructed by the rebar.
- Drill a hole $\varnothing 14\text{mm}$ in structural concrete 80mm in depth. Concrete quality at least C20/25 (20MPa based on cylinder test and 25MPa based on cube test).
- Clean bore by blowing it out, using a dust blower.
- Insert the M12 chemical fasteners (not included), using a setting tool in accordance with the instructions for installation and use provided by the adhesive manufacturer.
- Check for firm seat.
- Use hex nuts and/or locks nut (not included) to attach and tighten the intermediate bracket.

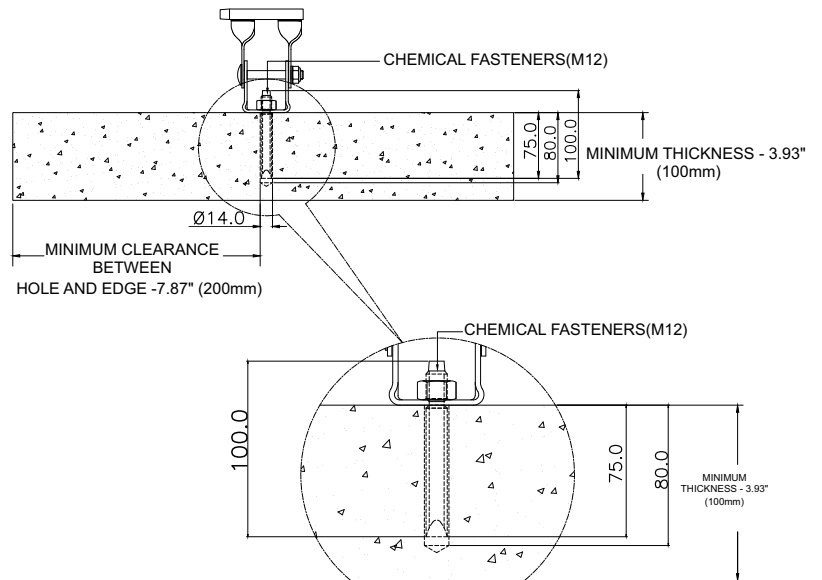

Intermediate Bracket (AFF111510)

- Using the rebar locator, mark the position of the holes which are not obstructed by the rebar.
- Drill a hole $\varnothing 14\text{mm}$ in structural concrete 80mm in depth. Concrete quality at least C20/25 (20MPa based on cylinder test and 25MPa based on cube test).
- Clean bore by blowing it out, using a dust blower.
- Insert the M12 chemical fasteners (not included), using a setting tool in accordance with the instructions for installation and use provided by the adhesive manufacturer.
- Check for firm seat.
- Use hex nuts and/or locks nut (not included) to attach and tighten the intermediate bracket.

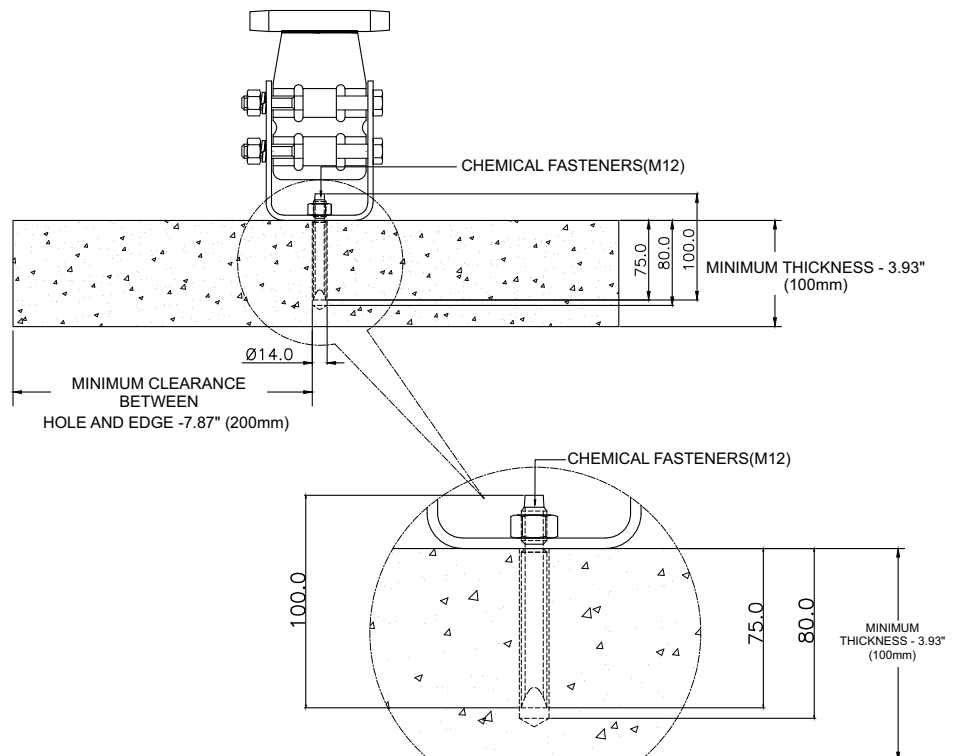

HORIZONTAL LIFELINE SYSTEM

Corner Post (AFA935204) and (AFA935207)

- Using the rebar locator, mark the position of the holes which are not obstructed by the rebar.
- Drill a hole $\varnothing 14\text{mm}$ in structural concrete 80mm in depth. Concrete quality at least C20/25 (20MPa based on cylinder test and 25MPa based on cube test).
- Clean bore by blowing it out, using a dust blower.
- Insert the M12 chemical anchors (not included) using a setting tool in accordance with the instructions for installation and use provided by the adhesive manufacturer.
- Check for firm seat.
- Use hex nuts and/or locks nut (not included) to attach and tighten the corner post.

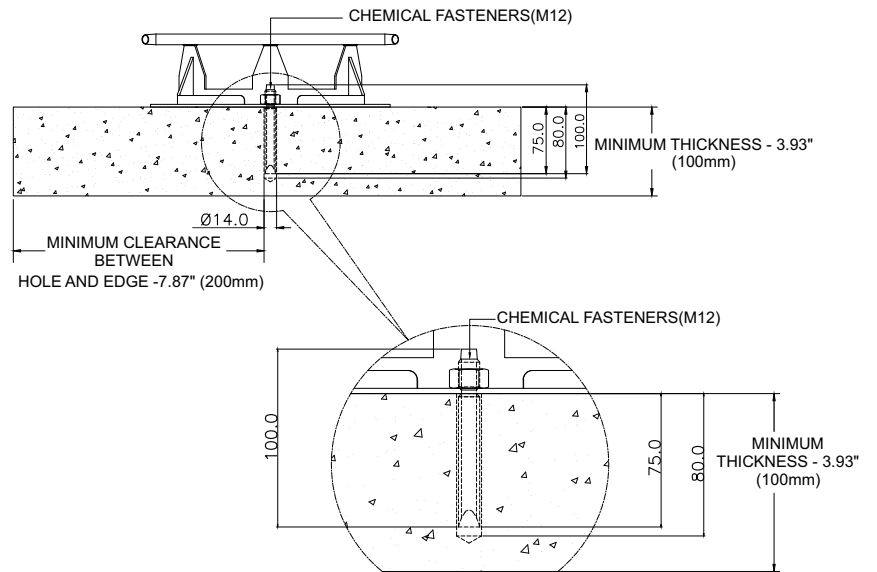

Fastening in Concrete Structure Using Fixed Anchor Posts (AFA935841):

- Using the rebar locator, mark the position of the holes which are not obstructed by the rebar.
- Drill 4 nos. of hole $\varnothing 14\text{mm}$ in structural concrete 80mm in depth, following the distance between the holes of the base plate. Concrete quality at least C20/25 (20MPa based on cylinder test and 25MPa based on cube test).
- Clean Holes by blowing it out, using a dust blower.
- Insert the M12 chemical fasteners (not included) using a setting tool in accordance with the instructions for installation and use provided by the adhesive manufacturer.
- Check for firm seat.
- Use hex nuts and/or locks nut (not included) to attach and tighten the base plate of the fixed anchor.
- Mount the lifeline components (extremities, corners and intermediates) on the top plate using the included fasteners.

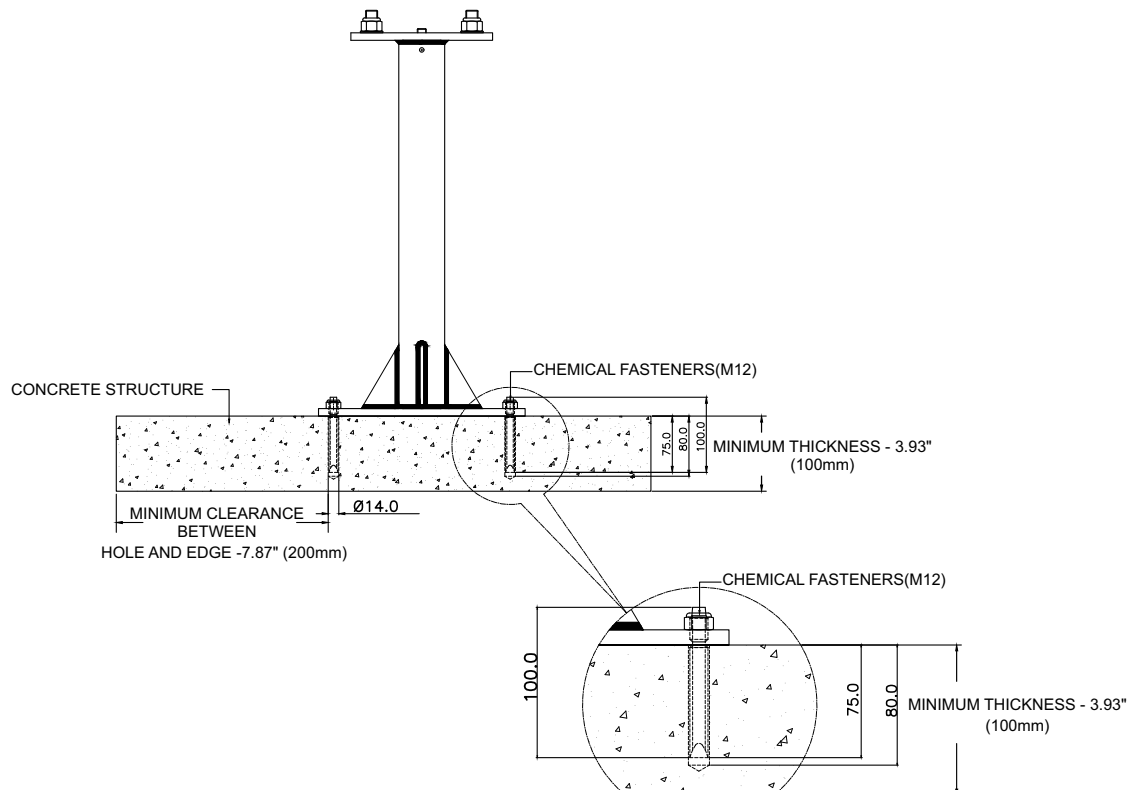

Installation of the System

Step 1: Swaging & adding Extremity Stopper

Equipment

- **Swaging Tool**

- The swaging Tool is the most important equipment to ensure a robust swage. Swaging must be performed by a hydraulic Swaging tool capable of providing a force of 120kN.

Note: Please use the right swaging tool.

- **Hex Loc Die.**

- Selection of the right size of Hex loc die is critical. Ensure that the hex loc Die has dimensions as in the Fig1.

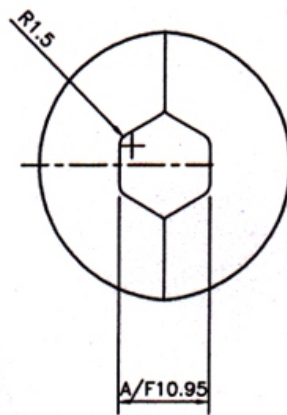

Note1: The size of the Die available on the market nearest to the recommended size in Fig.1 is 50mm²

Note2: Inspect for wear and tear of the dies before each swaging .Replace the dies if the edges are rounded.

Process

- Insert the cable into the swage tube. Mark the cable by a marker at the edge of the swage tube. Pull the cable out of the swage tube and check if the cable had been inserted fully ,by placing the cable over the swage tube.
- Insert the Cable in the tube again, until the edge of the swage tube coincides with the marking on the cable. We now know that the cable has been fully inserted in the swage tube.
- The swage tube is marked to identify exact positions of swaging.
- Place the swage tube on the hex loc die of the hydraulic swaging tool. See Fig2

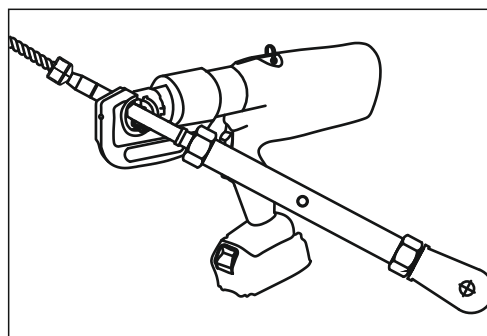

Fig:1

- While placing the swage tube on the hex loc die, ensure that the mark on the swage tube is in the center of the die.
- Set the hydraulic swaging tool to 120kN force.

HORIZONTAL LIFELINE SYSTEM

- Apply a slight force on the swage by pressing the switch of the swaging tool and releasing it to ensure that the swaging has started and the swage is placed in the right position. Now press the switch again to provide the required 120 kN Pressure. Continue Pressing the switch until the green light is on, to indicate that the 120kN force has been achieved.
- Repeat the process for all markings. Rotate the Swage at 90 degrees after each
- Swaging to ensure that the tube does not bend.
- To ensure that the tube does not bend the following sequence of swaging may be followed as good practice.
 - 1st swage: Top
 - 2nd swage: Bottom
 - 3rd & 4th swage: Middle
 - 5th and 6th swage: Remaining swage.
- Check the tube after each swaging for any signs of bending. Decrease/increase Rotation of the tube if required to offset the bend due to previous swaging.

Applying Tension To the line Hold the tensioner eye.

- Insert the tensioning tool in the housing of the tensioner and rotate the tensioner in clock wise direction. Rotate it until reasonable tension is achieved in the cable and the tension indicator plate is in contact with the shock absorber coil.
- Tighten both the chuck nuts.

Mounting the tensioner on the system.

- Open the threads of the tensioner from both ends. Ensure 75% of the thread is open.
- Insert the locking pin so as to pass through the eye of the tensioner and the shock absorber.
- Insert the label ID tag in the pin ring and the locking pin to lock it.

Mounting the tensioner on the system

- Open the threads of the tensioner from both ends until red mark on the thread is visible.
- Insert the locking pin so as to pass the eye of the tensioner and the shock absorber.
- Insert a pin ring in the locking pin to lock it.

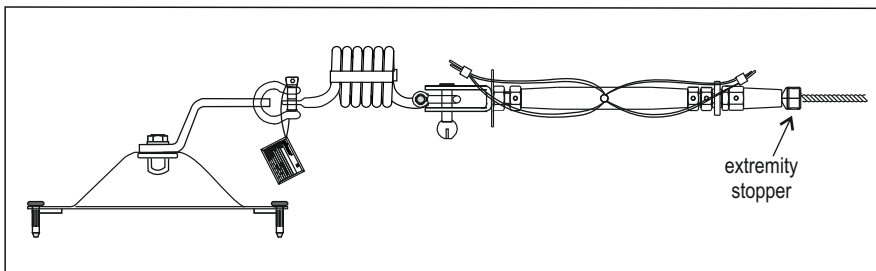

Cable Termination & Shock Absorber Ref. AFF4000 Overhead, Wall & Ceiling Mounted

STEP 1: SHOCK ABSORBER: Ref. PN AFF112100 & AFF114112

- Connect the D-Shackle directly to the universal extremity plate and tighten the locking bolt

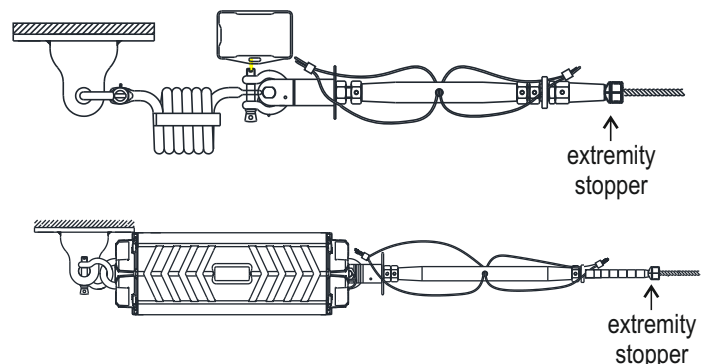

HORIZONTAL LIFELINE SYSTEM

Tensioner & Intermediate Ref. AFF4000 Overhead, Wall & Ceiling Mounted

STEP 1: MOUNTING THE TENSIONER ON THE SYSTEM

- Connect the other D-Shackle directly to the tensioner and tighten locking bolt.
- Open the threads of the tensioner from both ends. Ensure 75% of the threads are open.
- Insert the locking pin so as to pass the eye of the tensioner and the shock absorber.
- Insert a pin ring in the locking pin to lock it.
- Install the Extremity stopper over the wire before attaching to tensioner.

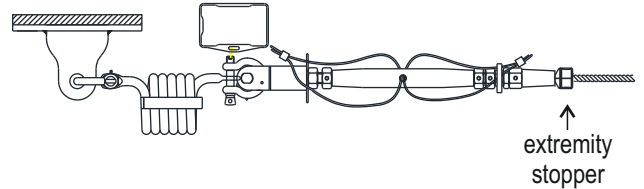

STEP2: APPLYING TENSION TO THE LINE

- Hold the tensioner eye
- Insert the tensioning tool in the housing of tensioner and rotate tensioner in clock wise direction. Tension should be applied slowly. After terminating the wire, tension the cable to ensure the sag in the last span is reduced. Remove the U bolts that have been previously installed after each intermediate.
- Now tension the cable again until the TFI starts rotating freely, this ensures adequate amount of tension has been achieved in lifeline.
- Tighten both the chuck nuts.
- Tighten the grub screws on chuck nuts.
- Tie the tie cords and lock them with ferrule.

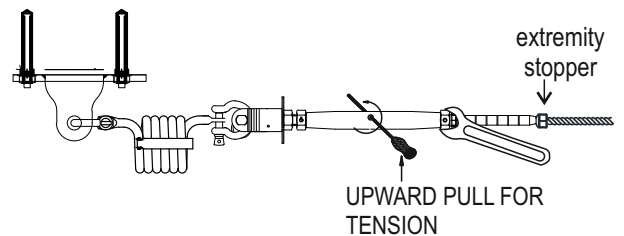

STEP3: APPLYING TENSION TO THE LONG SPAN LIFELINE 1x19mm WIRE ROPE

The process to follow in connecting the swaged cable termination is as Follows:

- Insert the wire in the swaged cable extremity and swage it using a swaging machine.
- Hold the swage by a spanner, there are slots for spanner at the end of the swage to hold it .
- Unscrew the Chuck nut in the housing as far back as possible.
- Screw in the housing in to the swage assembly while holding the swage tube with the spanner to ensure that the wire rope does not rotate while tightening the housing.
- Once the swage tube is tightened in to the housing , tighten the Chuck nut to lock the housing to the swage tube.
- Now remove the pin of the housing and insert it in to the housing in to the universal extremity plate or a D shackle.
- Insert the pin and tighten the nut.
- Insert the pin ring in to the pin to secure the nut.

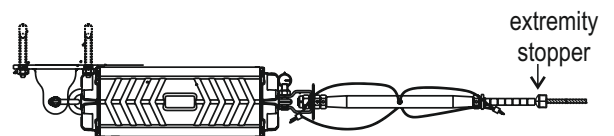

STEP4: IMPACT INTERMEDIATE 220 DEG SWIVEL BRACKET; Ref. AFF111525

- Insert the cable through intermediate
- Connect the intermediate to the receiving structure with fastener.
- The Intermediate may be changed to suit different angled structures by undoing the bolt and adjusting the swivel and then re-tightening once in position.

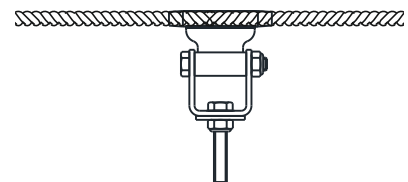

STEP 5: OPTIONAL - INTERMEDIATE; Ref. AFF111510

- Insert the cable through intermediate
- Connect the intermediate to the receiving structure with fastener.
- The angle of the Intermediate may be changed by inserting intermediate fastener to different holes provided.

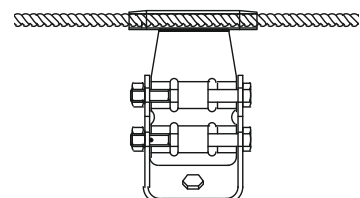

HORIZONTAL LIFELINE SYSTEM

Traveler Ref. AFF4000 Overhead, Wall & Ceiling Mounted

STEP 1: Traveler Ref. AFF119028

The traveler may be attached or detached from the line at any given point.

1. Remove karabiner from Traveler, open the gate
2. Insert traveler directly onto the wire
3. Close the gate after connecting with wire
4. Insert Karabiner allowing a secure connection to the wire

To connect to the user, (which moves along the length of the line), connect the lanyard or SRL directly to the karabiner attached to the traveler.

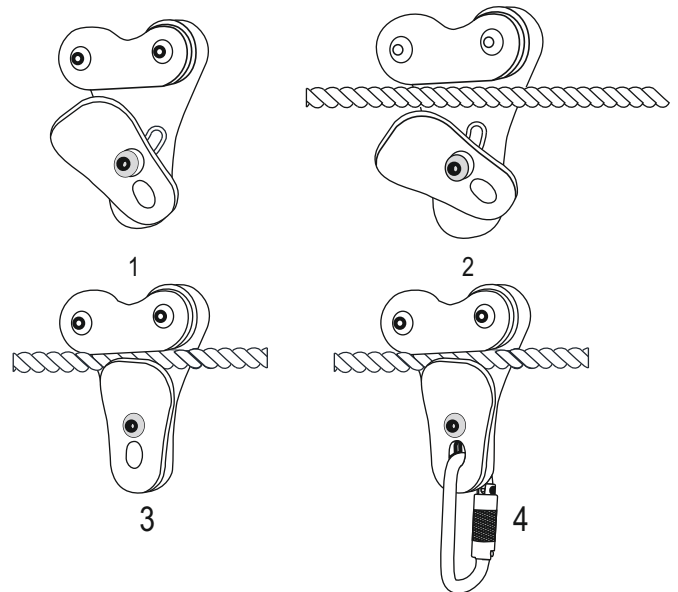

STEP 1: Traveler Ref: AFF119025

The traveler may be attached or detached from the line at any given point.

1. Remove karabiner from Traveler, open the gate
2. Insert traveler directly onto the wire
3. Insert Karabiner allowing a secure connection to the wire

To connect to the user, (which moves along the length of the line), connect the lanyard or SRL directly to the karabiner attached to the traveler.

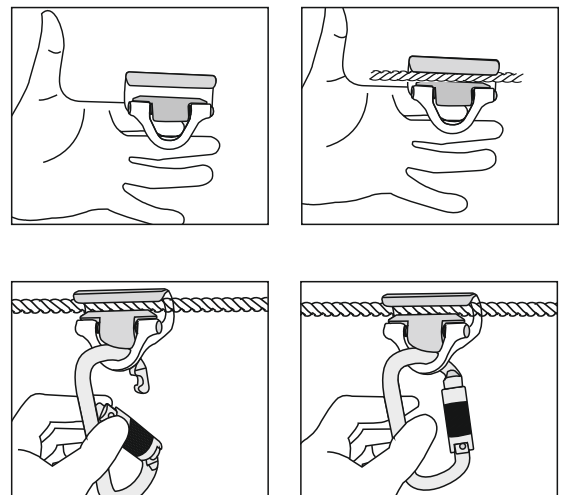

RECOMMENDED PPE:

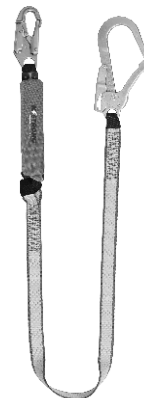

Pre-Use Checks and Precautions

Post Installation Inspection

- Once installed, it is important to inspect the complete line by moving the entire length of life line
- It is mandatory for the Site Inspector/ Supervisor and the actual users of the system to perform a thorough check before carrying out work. KStrong conducts a brief training of all concerned personnel on the subject of pre-use inspection of the system as per a defined guideline after the system has been installed by KStrong personnel.

Checking the Receiving Structure

Do not install the system if the receiving structure does not meet the minimum structural strength of 12kN (EN) or 15kN (AS/NZS) . If in doubt, refer to an Engineer.

Perform pull-out test to ensure that the concrete structure is able to withstand the required load

Checking the System

- Clean the system from dust/dirt. Check for any mechanical defects.
- Check for wear and tear in all components or unusual bending or deformation.
- Check for any modifications done by the user.
- Check for any missing component.
- Check for any damages that may have been caused due to welding while maintenance of other equipment.
- Check the Identification Plate. The system needs to be put out of service if the label is not legible or missing.

Checking the Cable

- See that there is sufficient tension on the cable by checking the tension indicator in the shock absorber.
- Check the condition of the cable. Wear hand gloves and check the wire from all sides. Check for broken strands or any deformity in the cable. Report if strands are found broken.

Checking the Traveler

- Check the smooth movement of the traveler before each usage. If friction is noticed, it can be due to dust accumulated due to continuous use.
- Clean with a soft cloth using silicon spray
- Only use a karabiner at the termination end of the lanyard to slide the traveler on the cable.

Precautions While Using the System

The following points and precautions needs to be considered for safe use of the system

- The life line is for the purpose of fall protection while working on a horizontal plane at height. A back up fall arrest system is required when transitioning on and off the life line system while working at height.
- Never disengage the fall arresting lanyard and the traveler from the life line while working at height.
- Avoid using grease to lubricate the system. If any fall is reported, put the system out of use. Contact the manufacturer for repairs and re-validation.
- Only certified full body harness with proper attachment anchorage points should be worn while using the AFF4000 system.
- Do not alter or misuse this equipment. Always take the advice from KStrong personnel while using this equipment in combination with components or subsystems other than those described in this manual. Usage of certain component/sub system may interfere with the proper functioning of this equipment and the system may not deliver or work as per its intended use. In such case KStrong may not be held responsible for any malfunction.
- The lifelines must be kept free from dust, grease etc., by periodic cleaning. The system can be cleaned by a soft dry cloth.

Hazards

Hazards existing in immediate environment may require additional precautions to limit the possibility of injury to the user or damage to the equipment. Hazards may include but are not limited to, extreme temperatures, caustic chemicals, corrosive environments, high voltage power lines, explosive or toxic gases, moving machinery, sharp edges, high velocity winds etc.

Do not expose the equipment to any hazard which it is not designed to withstand. Consult the manufacturer if in doubt.

Rescue Plan

It is recommended to ensure that the user shall have a rescue plan and means to execute it while using this equipment. The rescue plan needs to be project specific. The employees must be trained in self-rescue or alternative means shall be provided for prompt rescue in an event of a fall.

It is recommended to work in a pair to ensure that in an event of a fall your partner may help in rescue.

Annual Inspection & Revalidation

According to the requirement of EN365, every PPE needs to be inspected at least once in a year. The KStrong COMPASS software maintains the data of the system for at least 20 years and reminds the client whenever the inspection is due. The KStrong Inspection team is trained to perform the inspection and provide a certificate each year at a nominal cost. The client may at any given moment of time extract the status of any of the lifeline installed anywhere in the world from the KStrong data base.

Environment

To protect the environment, KStrong follows a 100% paperless process. Unless specifically required, KStrong avoids printing its reports and make it available to the client digitally.

HORIZONTAL LIFELINE SYSTEM

Inspection Use and Maintenance

PPE Inspection and Revalidation

Fall Protection Equipment is a life saving product. As per the EN 365 of PPE Regulations 425/2016, it is mandatory to have a 'Competent Authority' to inspect the Fall Protection Equipment at least once annually.

KStrong COMPASS Inspection software helps taking care of the equipment for at least 20 years.



- Cloud based online as well as off line software
- Captures geo coordinates where the system is installed
- RFID / Bar code compliant
- Generates report in real time
- Reminds user of items due for inspection
- Captures images of components
- User customizable
- Can be integrated to client software
- Reports can be shared with multiple recipients in real time

Infrastructure:

- Good quality equipment complying with international standards
- 100% backward oriented manufacturing unit
- Qualified engineering crew
- Sophisticated test equipment
- Precise engineering software to understand the client requirement to provide a safe & optimum solution
- Technical marketing team capable of understanding the client requirement & present the solution using engineering drawings (Auto CAD) & calculations
- Force predictions on the system in an event of a fall and a testing facility to validate the force calculations

Fixed Lifeline System Projects can be Executed in 3 Steps :

Site Visit

- Site engineer visits the client's site to check & understand the requirement.
- Site measurements using sophisticated equipments like digital distance meter & special imaging tools.
- Simulations of forces on the receiving structure using advanced engineering software like STADPRO.

Providing Good Quality Material

- MOC of KStrong fixed line components is Stainless Steel Grade 316 and Aluminum which are tested using a spectrophotometer to ensure the quality parameters.
- State of the art test lab using high precision dynamometers, oscilloscopes & slow motion cameras to validate predictions & simulations claimed.
- The only manufacturer having 100% backward oriented plant & undertaking to supply spares for a minimum period of 20 years.

Installation

- Proof loading of the system using Hydra Jaws (UK) equipment for onsite horizontal lifeline testing: Post Execution Care
- Software based support for inspection of the system annually.

Warranty

The system is produced with extreme precision. Should there arise a manufacturing defect within a period of 1 year of supply, KStrong stands to repair the components or replace if necessary.

Warranty does not cover:

- Deficiency arising out of misuse of equipment
- Malfunction due to faulty installation/wrong usage of product
- This equipment is not user maintainable. The warranty stands void if an attempt is made to repair or open the equipment.

KStrong does not provide a product functioning warranty; the warranty stands for the workmanship of the products only.

- KStrong Systems are made of stainless steel grade 316, ED Coated Steel or Aluminum and are highly resistant to corrosion.
- KStrong systems are thus further warrantied for 20 years (15 years in Marine Environment) are inspected once annually according to the requirements of EN365.

HORIZONTAL LIFELINE SYSTEM

Tools Required



RING SPANNER



DOUBLE END SPANNER



SOCKET SET



TENSIONER TIGHTENING TOOL



CRIMPING PLIER



BOLT CUTTER



ALLEN KEY

Machines



CORDLESS DRILL MACHINE



HAMMER DRILL MACHINE



CORDLESS IMPACT WRINCH



HYDRA JAWS
LIFELINE TESTING



SWAGING TOOL



HYDRAULIC CRIMPING HEAD



POWER BIRD RIVETING MACHINE

Anchors

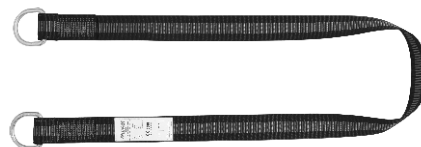
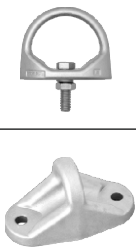

HORIZONTAL LIFELINE SYSTEM

Measuring Tools

					
TAPE	DETECTOR	DIGITAL TORQUE WRENCH	DISTANCE METER	LASER TOOL	VERNIER

Consumables, Miscellaneous Tools

						
DUST PUMP	HOLE SAW CUTTER	HOT AIR GUN	SETTING TOOL	PAINT BRUSH	DRILL BIT	IMPACT DRILL
						
BLOWER	CHEMICAL APPLICATOR					

WRENCH SIZE					
Hex Bolt	6	8	10	12	16
Wrench Size	10	13	16	19	24
Socket Size	10	13	16	19	24

ALLEN KEY SIZE				
Allen Bolt Size	6	8	10	12
Allen Key Size	4	6	8	10
Allen Grub Screw Key Size	3	4	5	6

Torque Chart (Maximum torque for standard bolts)

CHART							
Bolt size	M6	M8	M10	M12	M14	M16	M10 Standing Seam
Recommended Torque:	17 Nm	30 Nm	45 Nm	50 Nm	56 Nm	70 Nm	26 Nm

Proof Loading

Process of Proof Loading of Horizontal Lifelines

Proof loading of roof post (Non Destructive)

- Post installation at least 10% of the posts should be proof loaded by a load testing device. The posts should be subjected to a static load of 6kN for a period of 1 minute in accordance with EN 795 (4.4.1.1). The permanent deflection as a result of proof loading should not be greater than 10mm after the load is released

Proof loading of termination(Non Destructive)

- Each cable end termination should be proof loaded by a load testing device, to a static force of 6kN. The force is held for 1 minute. The proof loading ensures that the end cable terminations are robust and will not release the cable in an event of a fall.

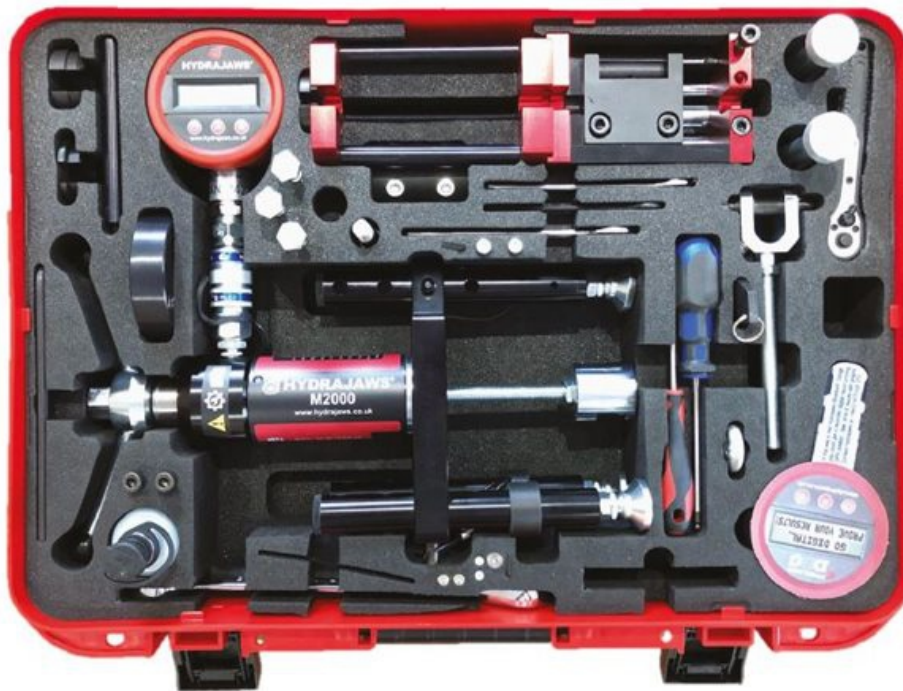

HYDRA JAWS LIFELINE TESTING



KStrong Asia Pte Ltd
33A Chander Road,
Singapore 219539
Email: customercare@kstrong.com

www.kstrong.com

USA

South America

Asia
