



---

## INSTALLATION GUIDE FXLINE SYSTEMS

CE 0598

THESE INSTRUCTIONS APPLY TO THE FOLLOWING MODEL:

**Vertical Life Line Systems**

FXline AFF6000  
FXline AFF7000  
FXline AFF8000  
FXline AFF9000

**Horizontal Life Line Systems**

FXline AFF4000 Roof Mounted  
FXline AFF4000 Floor & Overhead  
FXline AFF5000

Please read and understand the manufacturer's instructions for each component or part of the complete system. Manufacturer's instructions must be followed for proper use, care, and maintenance of this product. These instructions must be retained and be kept available for the user's reference at all times. Alterations or misuse of this product, or failure to follow instructions, may result in serious injury or death.

**Note:** The user is advised to keep this user instructions document for the life of the product.

**Warning:** The products enumerated in this instruction manual are a part of personal protective, work support, or rescue system. The user must read and follow the manufacturer's instructions for each component of the system. This manual contains information that is important to the user's safety and should be kept in a safe place for future reference as needed. Please contact KStrong for any questions regarding the use of this equipment. Fall arrest systems and equipment are lifesaving products and are designed to reduce the potential of serious injury in the event of a fall. However, in the event of a fall, the user may experience a force on their body. In case there is a doubt about the user's ability to utilize this product, the user must consult a physician. Pregnant women and minors are not considered fit for the use of this equipment..

INDEX		
Product	Code	Page No.
Vertical Anchorage Lifeline System on Rigid Cable Line	FXline AFF6000	2
Vertical Anchorage Lifeline System on Rigid Cable Line	FXline AFF7000	3-9
Horizontal Anchorage Life Line System	AFF4000 (Floor/Ceiling Mounted)	10
Horizontal Anchorage Life Line System	AFF4000 (Roof MOUNTED)	11-21
Vertical Anchorage Lifeline System on Aluminium Rail System and Vertical Anchorage Lifeline System on Aluminium Rails with Rungs	AFF8000 & AFF9000	22-26
Horizontal Aluminum System	AFF5000	27-30
Proof loading		31
Pre-Use Checks		31
Precautions		32
Kstrong Compass App		32
Tools		33
Torque Chart		34
Equipment Record		

If there are any questions or queries about installation, usage, inspection or maintenance our team would be Happy to Help.

Please forward your inquiry to: [customercare@Kstrong.com](mailto:customercare@Kstrong.com)

**Disclaimer:** Illustrations may be changed without notice. All dimensions and specifications are approximate and drawings not to scale.

# 1. VERTICAL ANCHORAGE LINE SYSTEM ON RIGID CABLE LINE

Ref: FXline AFF6000

Conforms to: EN353-1:2014 + A1:2017



Wire Rope (Cable Wire) with D Shackle  
Ref. AFF518XXX(DS) (where XXX is the length of the wire rope in meters)

- Material: Stainless Steel 316
- Diameter: 8mm
- Construction: 7x19
- D Shackle: Stainless Steel



Intermediate  
Ref. AFF511500

- Material: Stainless Steel Grade 316
- Recommended Installation - Every 10 m



Wire Rope Cap  
Ref. AFF513100

- Material: Aluminium Alloy

Inspection Plate  
Ref. AFF115100

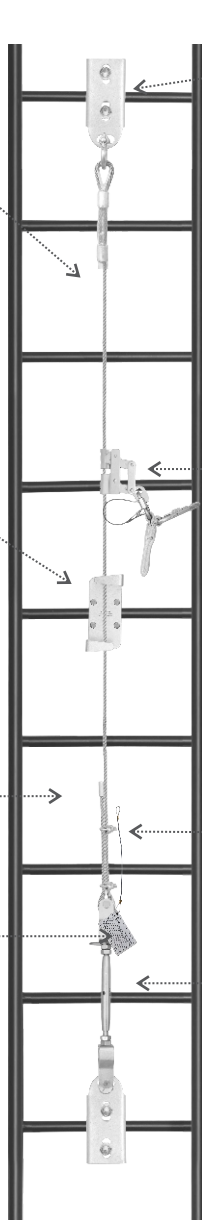

Optional  
Extension Arm (Finish-ED Coating Black) - Ref.: AFF516800



Mounting Bracket  
Ref. AFF511000

- Material: Stainless Steel 316
- Breaking Strength > 23 kN
- Compatible with rung diameter: Ø25.0mm - Ø96.0mm
- Complies with EN 795 Type A

Optional  
Mounting Bracket  
Ref. AFF511001

- Material: Stainless Steel.
- Minimum Breaking Strength: 23 kN
- Compatible with rung diameter- Ø22.0mm-Ø114.0mm

Rope Grab  
Ref. AFG805203

- Material of Rope Grab: Stainless Steel Grade 316
- Anti inversion mechanism
- Material of Karabiner: Alloy Steel

Shock Absorber



Set of 2 U-Bolts and 1 Thimble  
Ref. AFF513000

- U- Bolts : Qty- 2 nos.  
Material : Stainless Steel 316
- Thimble : Qty- 1 no.  
Material : Stainless Steel 316



Tensioner  
Ref. AFF514000

- Regulates tensioning of the cable Equipped with a Tension Indicator
- Material: Stainless Steel Grade 316
- Quantity: 1 nos



## 2. VERTICAL LIFE LINE SYSTEM

Ref: FXline AFF7000



Conforms to: EN353-1:2014 + A1:2017

Shock Absorber  
Ref. AFF512000

- Material: Stainless Steel 316
- Limits the impact of force in the event of fall to less than 6 kN



Wire Rope (Cable Wire)

Ref. AFF518XXX (Where XXX is the Length of the wire rope in meters)

- Material: Stainless Steel 316
- Diameter: 8mm
- Construction: 7x19

ALSO AVAILABLE

Wire rope without loop Ref. AFF518XXX(S)

Intermediate  
Ref. AFF511500

- Material: Stainless Steel 316
- Recommended Installation- Every 10 m



Wire Rope Cap  
Ref. AFF513100

- Material: Aluminium Alloy



Inspection Plate  
Ref. AFF115100



Mounting Bracket\*  
Ref. AFF511000

- Material: Stainless Steel 316
- Breaking Strength > 23 kN
- Complies with EN 795 Type A

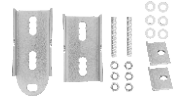

Wire Crimping Assembly

Rope Grab  
Ref. AFG805101

- Material of Rope Grab: Stainless Steel 316
- Material of Karabiner: Alloy Steel
- Anti inversion mechanism



Set of 2 U-Bolts & 1 Thimble  
Ref. AFF513000

- U - Bolts: Qty - 2 nos. Material: Stainless Steel 316
- Thimble: Qty - 1 no. Material: Stainless Steel 316



Tensioner  
Ref. AFF514000

- Regulates tensioning of the cable. Equipped with a Tension Indicator
- Material: Stainless Steel 316.
- Quantity: 1 nos.

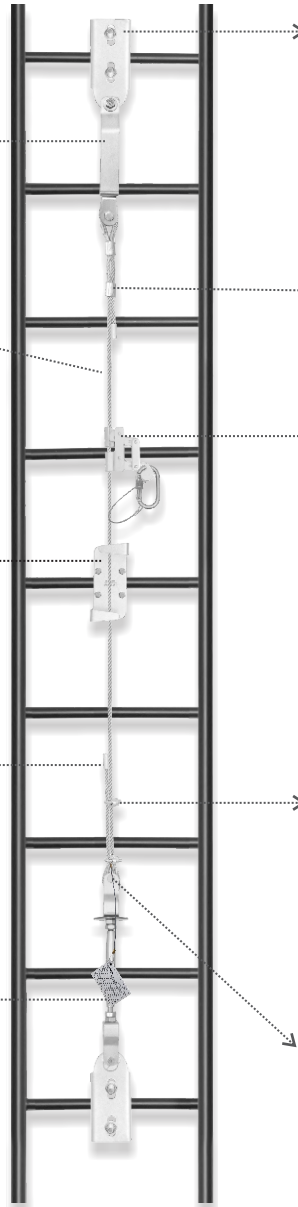

## CABLE TERMINATION

Ref. AFF6000 & AFF7000

### STEP 1: CABLE TERMINATION

- A suitable cable termination may be selected according to the site condition, u-bolts and thimbles are only allowed at bottom termination according to EN353.1:2014

### STEP 2: WIRE CRIMPING ASSEMBLY

- Insert 2 ferrules in the wire.
- Insert the wire in heat shrinking tube.
- Loop the wire across the Stainless Steel Thimble.
- Insert the end of the wire back into the Ferrule.
- Crimp the Ferrule using a 20 Ton Hydraulic Crimping head and 300mm<sup>2</sup> crimping dies.
- Ensure that the first ferrule is as close as possible to the thimble, the next ferrule should be 50mm apart from the first one.
- Insert the aluminum cap in the free end of wire and crimp it.
- Cover the entire assembly up to the bottom edge of the ferrule with a heat Shrinkable tube.
- Shrink the tube with a hot air gun.

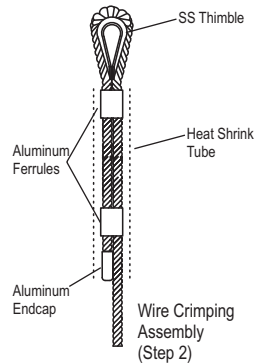

## CABLE TERMINATION

Ref. AFF6000 & AFF7000

### STEP 3: CABLE SWAGING

- Insert the cable into the swage tube.
- The swage tube has markings to identify exact positions of swaging.
- Place the swage tube on the hex loc die of a hydraulic swaging tool (130kN capacity).
- Ensure that the mark on the swage tube is in the center of the die.
- Operate the machine to start the swaging operation until the green light is on.
- Repeat the process for all markings(5 times minimum).

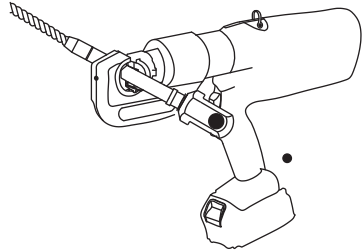

### STEP 4: U BOLT & THIMBLE

- Loop the Cable across the thimble and ensure at least 300mm of the cable is overlapping.
- Next, fasten the stainless steel U bolts (Part of Ref AFF513000) approximately 50 mm apart.
- If the cable is in excess make a loop and tie the loop with cable ties.
- If it is necessary to cut the cable, insert aluminium cap in the free end of wire rope and crimp it

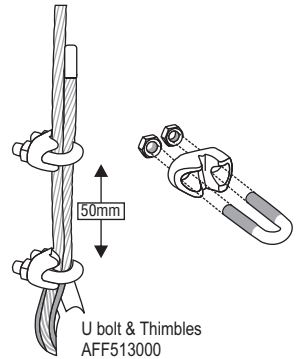

## INTERMEDIATE & TENSIONER

### Ref. AFF6000 & AFF7000

The intermediates reduces large deflections in the cable due to wind pressure.

#### STEP 5: INSTALLATION OF THE INTERMEDIATE: Ref. AFF511500

- Place fisher plate of the Intermediate on the back of ladder rung. Fasten the Intermediate Plate with the fisher plate with help of given fasteners. Ensure that the cable is in between the two arms of intermediate. It is recommended to install an Intermediate at an interval of every 10 m length of the Cable.

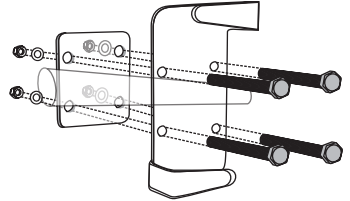

#### STEP 6: INSTALLATION OF THE TENSIONER: REF AFF514000

- The Tensioner is installed at the lower end of the system.
- Open the threads of extension rod of the tensioner from both ends. Ensure that 75% of the thread is open.
- Insert the eye of tensioner to the mounting bracket at the lower ladder rung.
- Insert the stainless steel locking pin so as to pass through the eye of the tensioner and the mounting brackets.
- Insert the pin ring in the locking pin to lock it.

#### FIX THE TENSIONER TO THE WIRE ROPE:

- Fix the thimble (part of Ref AFF513000) to the eye of the tensioner by the given fastener.
- Loop the Cable across the thimble and ensure at least 300mm of the cable is overlapping.
- Next, fasten the stainless steel U bolts (part of Ref AFF513000) approximately 50 mm apart.
- If the cable is in excess make a loop and tie the loop with cable ties.
- If it is necessary to cut the cable, insert aluminum cap in the free end of wire rope and crimp it.

#### PROVIDING TENSION TO THE WIRE ROPE:

- Open both the chuck nuts and hold the tensioner eye.
- Insert a steel rod in the housing of the tensioner and rotate the tensioner in anti clock wise direction.
- Rotate it until reasonable tension is achieved in the cable and the tension indicator disc is free to rotate.
- Tighten both the chuck nuts.



## SHOCK ABSORBER & CABLE TERMINATION

Ref. AFF7000

### STEP 7: INSTALLATION OF SHOCK ABSORBER

- Connect the shock absorber to top mounting bracket by inserting the fastener and the nylon spacer so as to pass through mounting bracket and eye of energy absorber.
- The spacer ensure the correct position of energy absorber.
- Ensure that the energy absorber is fitted with red arrow on label pointing down wards.
- Connect the end extremity to energy absorber by inserting fastener through eye of energy absorber.



### STEP 8: CABLE TERMINATION

- A suitable cable termination may be selected according to the site condition, u-bolts and thimbles are only allowed at bottom termination according to EN 353.1:2014



## EXTENSION ARM

Ref. AFF6000 & AFF7000

### STEP 9: INSTALLATION OF THE EXTENSION ARM: Ref. AFF516600

If the System has been provided with the Extension Arm, this shall be installed in place of Upper Mounting Bracket as in step:

- The Extension Arm is provided pre-installed with the Mounting Bracket for the Upper end of the system.

Follow The Simple Steps For Easy Installation-top Rung

- Hold the extension arm against the upper last three rungs of the ladder.
- Hold the fisher plate in front of the extension arm.
- Insert the given U- bolts through the rung in to the fisher plate. Tighten the nuts of the U-bolts
- Repeat the exercise for the Second Rung from the top.
- On the third rung of the ladder, from the top Insert the given U-bolt through the ladder rung in to the slot so as to pass through the extension arm tighten the nuts of the U-Bolt.

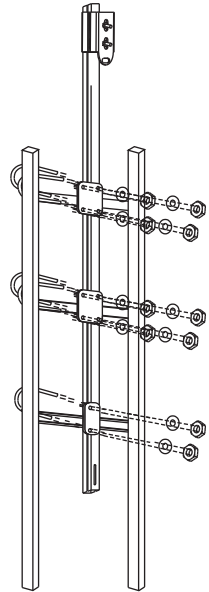

### STEP 10: LABEL AFF115100

- The Label is fixed to the lower most rung of the ladder using cable ties.

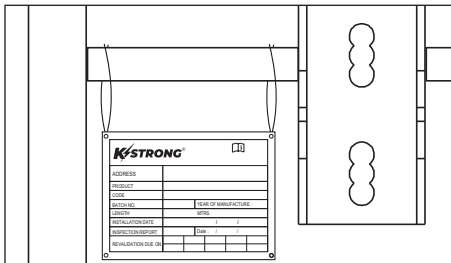

## FALL ARRESTER

Ref. AFF6000 & AFF7000

### STEP 11: INSTALLATION OF THE ROPE GRAB:

Ref. AFG805203

Connect Rope Grab to the Cable following the given simple steps:

- Hold the Rope Grab as shown in the figure.
- Push the Rope Grab through the cable and rotate it counter clockwise.
- Ensure the arrow on Rope Grab points up wards.
- Insert the karabiner of the shock absorbing lanyard AFG8052031 12 in the eye of the Rope Grab.
- Connect the other end of the shock absorbing lanyard to the harness of the user by the other Karabiner.

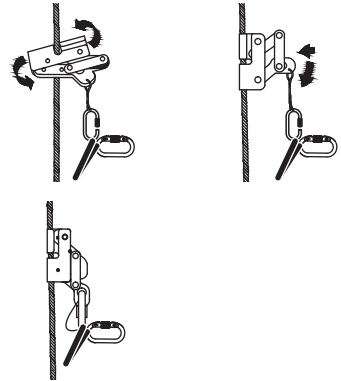

### STEP 12: CONNECT THE HARNESS TO THE ROPE GRAB

- Check the harness that all the straps are connected and buckles are secured and the harness has been adjusted to give it a snug fit.
- Connect the Rope Grab to the front attachment point of the full body harness with the help of the Karabiner of the connecting lanyard.
- Ensure that the gate of the karabiner is closed and locked properly.



### RECOMMENDED PPE



## 5. HORIZONTAL LIFELINE Ref. AFF4000 (FLOOR/CEILING MOUNTED)

Conforms to  
EN 795:2012 Type C, TS 16415:2013

Swaged Cable Extremity  
Ref. AFF113210

- Allows crimping of the cable wire at the desired length, and eliminates danger of any loose wire.
- Material: Stainless Steel 316.
- Feature: Swage termination

Universal Extremity Plate  
Ref. AFF113710

- Material: Stainless Steel 316



Wire Rope (Cable Wire)  
Ref. AFF518XXX(S) (Where XXX is the Length of the wire rope in meters)

- Material: Stainless Steel 316
- Diameter: 8mm
- Construction: 7x19



Carriage body  
Ref. AFF119000

- Material: Stainless Steel 316
- Feature: Friction Free movement



Intermediate  
Ref. AFF111510

- Material: Stainless Steel 316
- Recommended Installation- every 15 mtrs.

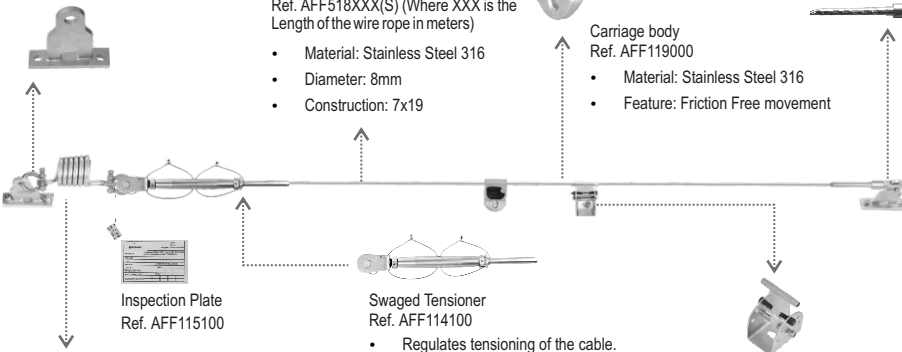

Inspection Plate  
Ref. AFF115100

Swaged Tensioner  
Ref. AFF114100

- Regulates tensioning of the cable.
- Material: Stainless Steel 316.
- Feature: Swaged termination.

Shock Absorber  
Ref. AFF112100

- Material: Stainless Steel 304



### OPTIONAL



Wheel Type  
Carriage Body  
Ref. AFF119100



Double Tandem Pulley Small  
with SS Sheaves  
Ref. AFX206009



## 7. HORIZONTAL LIFELINE

### Ref. AFF4000 (ROOF MOUNTED)

Conforms to  
EN 795:2012 Type C, TS 16415:2013

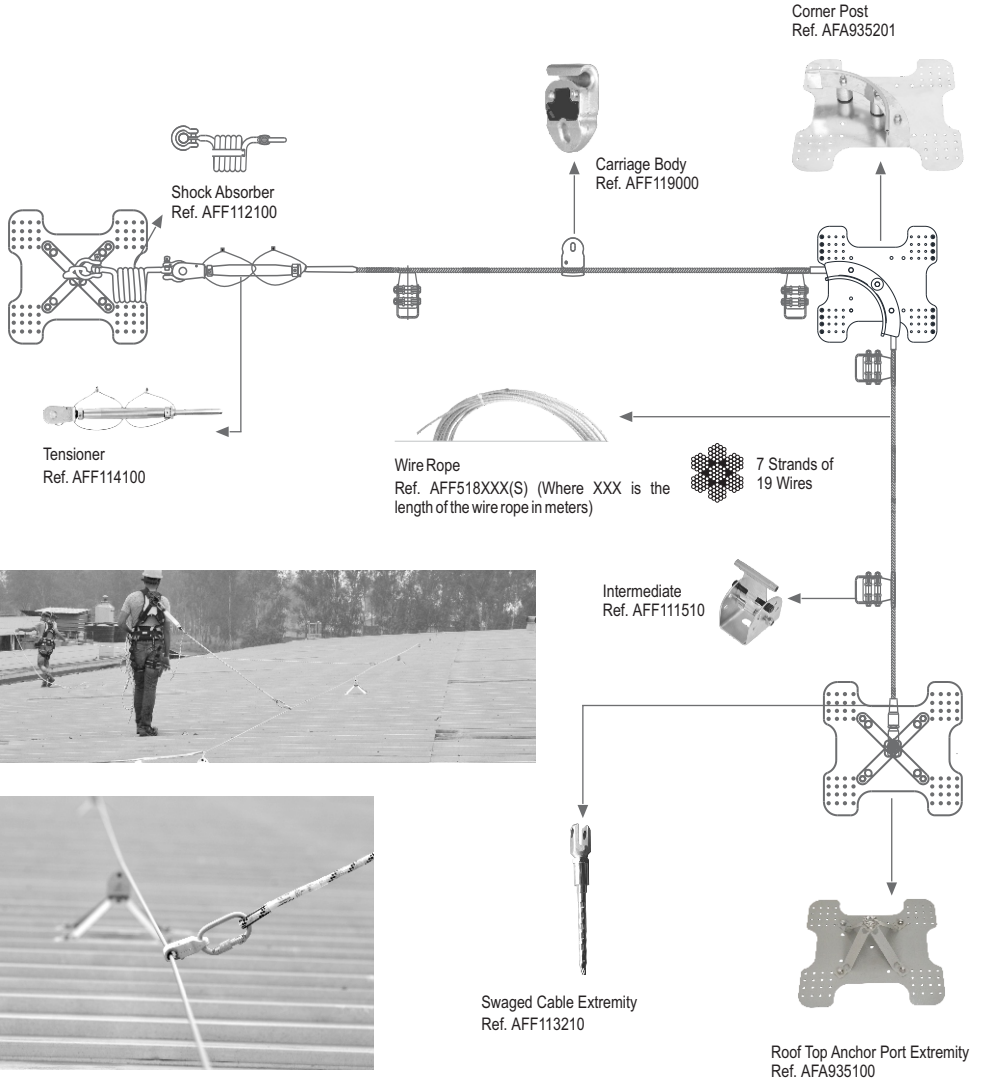

**TRAPEZOIDAL ROOF SHEETS**

Ref. AFF4000

These Posts are suitable for a variety of trapezoidal roof sheets with a minimum thickness of 0.40mm. The posts have multiple holes to suit different peak distances ranging from 217mm to 465mm.

**STEP A: ROOF TOP ANCHOR POST EXTREMITY; Ref. AFA935101**

- Mount the top and bottom brackets on base plates using nuts and bolts.
- Connect eye on the junction of top and bottom brackets
- Stick the base plates of post on the roof sheet with double adhesive tape.
- Drill 16 holes for the blind rivets. 4 drills each at 4 corners of base plates.
- Rivet with a riveting gun.

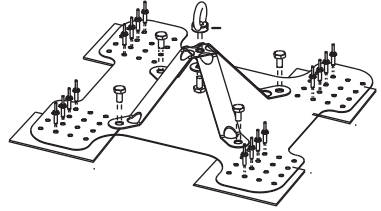
**STEP B: ROOF TOP ANCHOR POST INTERMEDIATE; Ref. AFA935151**

- Mount the top and bottom brackets on base plates using nuts and bolts.
- Stick the base plates of post on the roof sheet with double adhesive tape.
- Drill 16 holes for the blind rivets. 4 drills each at 4 corners of base plates.
- Rivet with a riveting gun

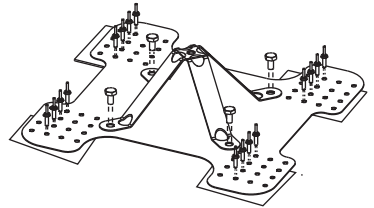
**STEP C: INTERMEDIATE BRACKET; Ref. AFF111510**

- Insert the cable through intermediate.
- Connect the intermediate on the junction of top and bottom brackets of roof post AFA935151 with fastener.
- The angle of Intermediate may be changed by changing the position of intermediate fastener (pair) in to different holes provided.

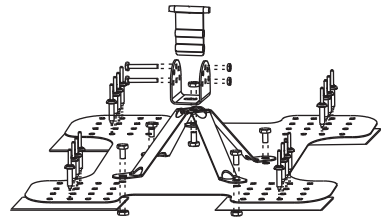
**STEP D: CORNER PIECE; AFA935201**

- Stick the base plates of post on the roof sheet with double adhesive tape.
- Drill 16 holes for blind rivets. 4 drills each at 4 corners of base plates.
- Rivet with a riveting gun.
- Insert cable through the Corner Tube.

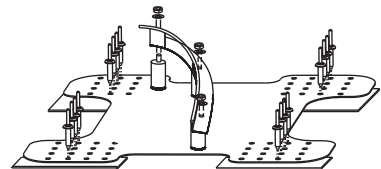

**TRAPEZOIDAL ROOF SHEETS****Ref. AFF4000**

These Posts are suitable for a variety of trapezoidal roof sheets with a minimum thickness of 0.40mm. The posts have multiple holes to suit different peak distances ranging from 217mm to 465mm.

**ROOF ENERGY ABSORBER POST; Ref. AFA935310**

- Stick the ends of the base plates of the post to the roof with double adhesive EPDM sheet.
- Drill 16 holes for the blind rivets.4 at each corner of the base plate.
- Rivet with a riveting gun.
- Cover the rivets with a weather proofing flash tape.

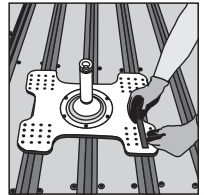
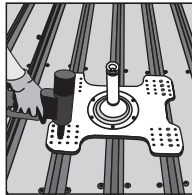
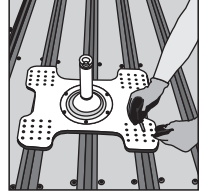
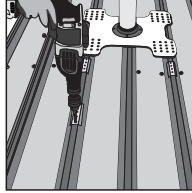
**ROOF CONSTANT ENERGY ABSORBER POST; Ref. AFA935320**

- Stick the ends of the base plates of the post to the roof with double adhesive EPDM sheet.
- Drill 16 holes for the blind rivets.4 at each corner of the base plate.
- Rivet with a riveting gun.
- Cover the rivets with a weather proofing flash tape.

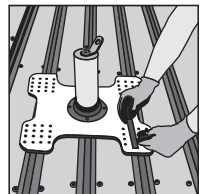
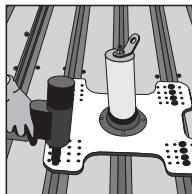
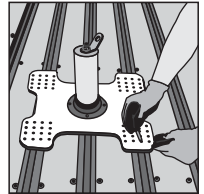
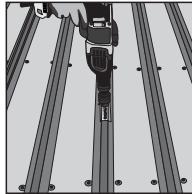

**STANDING SEAM ROOF SHEETS**

Ref: AFF4000

These Posts are suitable for a variety of Standing Seam roof profiles. The posts have multiple holes to suit different peak distances.

**STEP A: ROOF TOP ANCHOR POST EXTREMITY; Ref. AFA935102 / AFA935103**

- Mount the top and the bottom brackets on the base plates using nuts and bolts.
- Connect the eye on the junction of top and bottom brackets.
- Mount the roof post base plates on the seam clips with fasteners.
- Fix standing seam clips to the roof seam with grub screws.

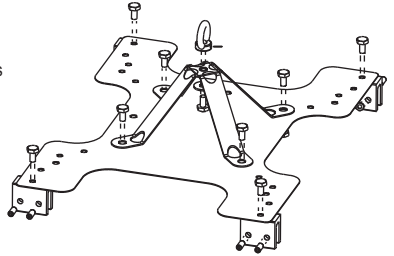
**STEP B: ROOF TOP ANCHOR POST INTERMEDIATE; Ref. AFA935152 / AFA935102**

- Mount the top and the bottom brackets on the base plates using nuts and bolts.
- Mount the roof post base plates on the seam clips with fasteners.
- Fix standing seam clips to the roof seam with grub screws.

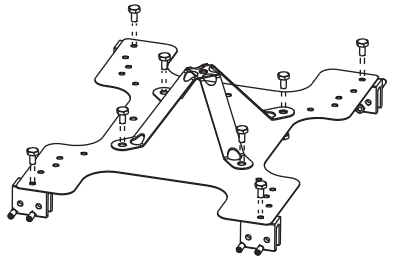
**STEP C: INTERMEDIATE BRACKET; Ref. AFF11510**

- Insert the cable through intermediate.
- Connect the intermediate on the junction of top and bottom brackets of roof post AFA935152 with fastener.
- The angle of Intermediate may be changed by changing the position of intermediate fastener (pair) in to different holes provided.

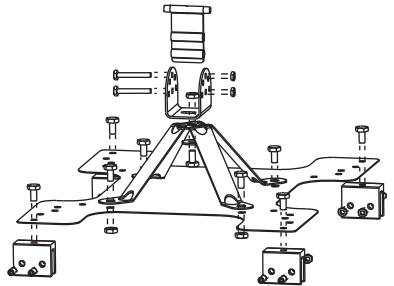
**STEP D: CORNER PIECE; AFA935202 / AFA935203**

- Mount the seam clips on the base plates of roof post with fasteners.
- Fix standing seam clips to the roof seam with grub screws.
- Insert cable through the Corner Tube.

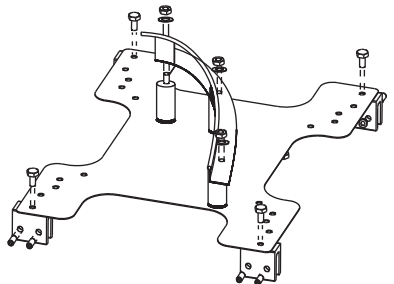

**STANDING SEAM ROOF SHEETS**

Ref: AFF4000

These Posts are suitable for a variety of Standing Seam roof profiles. The posts have multiple holes to suit different peak distances.

**CONSTANT FORCE ENERGY ABSORBER POST ; Ref. AFA935340**

- With grub screws and Allen bolts fix the standing seam clips to the seam.
- Mount the roof post base plates on the seam clips and with fasteners.
- Connect the eye at the top of the post. Lock the thread of the eye with the grub screw.

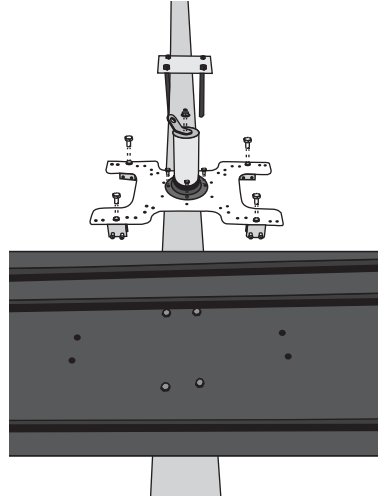



**Ref: AFF4000**

For fragile roof sheets, the sheet is to be cut open allowing the posts to be installed on the rafter or truss using Fischer plates. The posts are available in sizes of 300mm, 500mm, and 750mm and can be selected depending on the position of the rafter.

**STEP A: EXTREMITY ROOF TOP ANCHOR POST**

- Place the top flange of the post on the metal rafter of the roof.
- Hold the bottom plate on the bottom side of the structure or on the top flange in case of an I Beam.
- Insert the studs.
- Tighten the nuts on the top and bottom of the posts.
- Place the universal extremity plate on the top flange.
- Tighten the nuts and bolts to secure the universal extremity plate to the post.

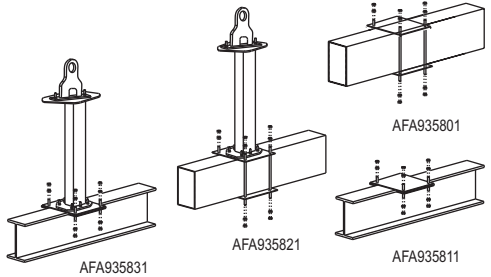

**STEP B: INTERMEDIATE ROOF TOP ANCHOR POST**

- Place the top flange of the post on the metal rafter of the roof.
- Hold the bottom plate on the bottom side of the structure or on the top flange in case of an I Beam.
- Insert the studs.
- Tighten the nuts on the top and bottom of the posts.
- Insert the cable in the Intermediate.
- Place the Intermediate on the top flange.
- Tighten the nuts and bolt to secure the intermediate to the post.

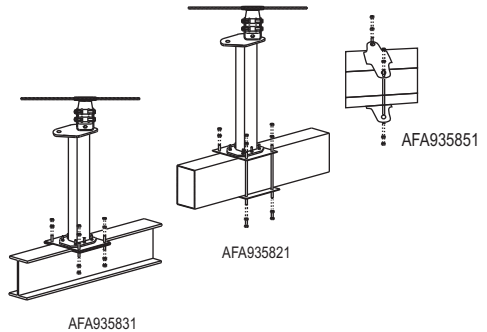

**STEP C: CORNER ROOF TOP ANCHOR POST**

- Place the top flange of the post on the metal rafter of the roof.
- Hold the bottom plate on the bottom side of the structure or on the top flange in case of I beam.
- Insert the studs.
- Tighten the nuts on the top and bottom of the posts.
- Insert the cable in the corner tube.
- Place the bottom flange of the corner piece on the top flange of the post.
- Tighten the nut and bolt to secure the corner to the post.

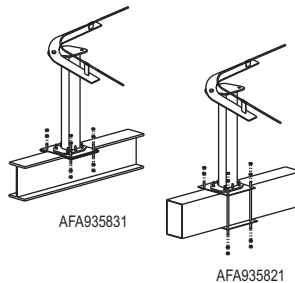

**TOGGLE ANCHOR**

This post can only be installed on the purlins

**Ref: AFA935301**

- Using a 36mm hole saw, drill a hole directly through the roof sheet and purlin.
- Adjust the flanges up or down the threaded stud (by rotating), so that when the pipe is inserted in the threaded stud, at least 15mm of thread is available at the top to tighten the eye.
- Insert the threaded stud with flanges closed to maximum, allowing the stud to pass through the hole. Once the flanges open, anchor will take its place.
- Insert the rubber washer followed by steel washer in the threaded rod.
- Insert a nut in the threaded rod and tighten it. Now the purlin and roof sheets are sandwiched between the flanges (at the bottom of the purlin) and the steel washer at the top of the roof sheet. The rubber washer helps in water proofing.
- Insert the base plate in the threaded rod. Ensure that the base plate sits firmly on two ribs of the roof sheet.
- Insert the pipe with a plastic pad at either end in the threaded rod.
- Tighten the anchorage Eye on the end of the threaded rod.
- Lock the threads of the eye by tightening the grub screw present in the eye with an Allen key.

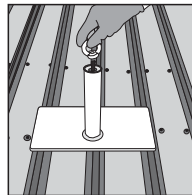
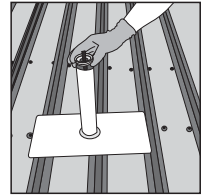
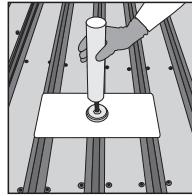
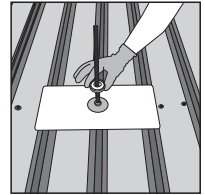
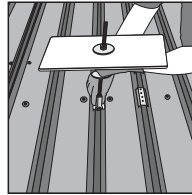
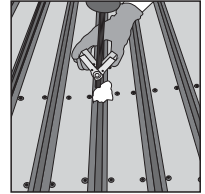
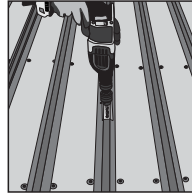

**TOGGLE ANCHOR**

This post is used as an intermediate post.

**Ref: AFA935301WE**

- Using a 36mm hole saw, drill a hole directly through the roof sheet and purlin.
- Adjust the flanges up or down the threaded stud (by rotating), so that when the pipe is inserted in the threaded stud, at least 15mm of thread is available at the top to tighten the eye.
- Insert the threaded stud with flanges closed to maximum, allowing the stud to pass through the hole. Once the flanges open, anchor will take its place.
- Insert the rubber washer followed by steel washer in the threaded rod.
- Insert a nut in the threaded rod and tighten it. Now the purlin and roof sheets are sandwiched between the flanges (at the bottom of the purlin) and the steel washer at the top of the roof sheet. The rubber washer helps in water proofing.
- Insert the base plate in the threaded rod. Ensure that the base plate sits firmly on two ribs of the roof sheet.
- Insert the pipe with a plastic pad at either end in the threaded rod.
- Now insert the intermediate AFF111510, and tighten the nut.

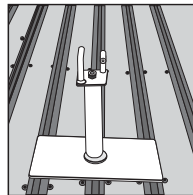
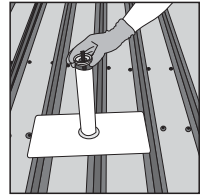
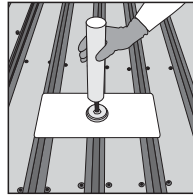
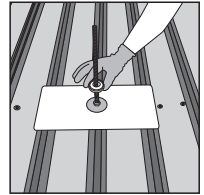
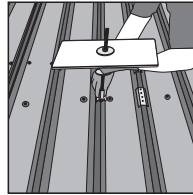
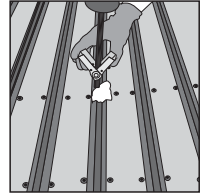
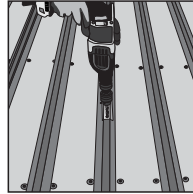

## CABLE TERMINATION & SHOCK ABSORBER

### Ref. AFF4000 Roof Mounted, Wall & Ceiling Mounted

#### STEP 1: UNIVERSAL EXTREMITY ANCHOR PLATE: Ref. AFF113710

The Universal Extremity Anchor plate can be installed on metal as well as concrete structure by using M16 fasteners. Chemical fasteners are used to fix the brackets to the concrete wall and Stainless Steel fasteners for metal structure. Refer to Hilti HVU installation guide for Chemical fasteners.

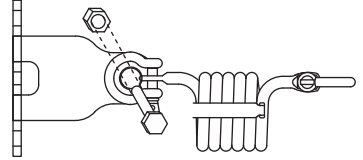

#### STEP 2: SHOCK ABSORBER: Ref. PN AFF112100

- Insert the connector to the universal extremity plate.
- Connect the other connector to the tensioner.

## TENSIONER & INTERMEDIATE

### Ref. AFF4000 Roof Mounted, Wall & Ceiling Mounted

#### STEP 1: MOUNTING THE TENSIONER ON THE SYSTEM

- Open the threads of the tensioner from both ends. Ensure 75% of the thread are open.
- Insert the locking pin so as to pass the eye of the tensioner and the Shock Absorber.
- Insert a pin ring in the locking pin to lock it.

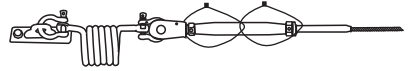

#### STEP2: APPLYING TENSION TO THE LINE

- Hold the tensioner eye
- Insert the tensioning tool in the housing of tensioner and rotate tensioner in clock wise direction. Tension should be applied slowly. After terminating the wire, tension the cable to ensure the sag in the last span is reduced. Remove the U bolts that have been previously installed after each intermediate. Now tension the cable again until the shock absorber coil touches the tension indicator L plate.
- Tighten both the chuck nuts.
- Tighten the grub screws on chuck nuts.
- Tie the tie cords and lock them with ferrule.

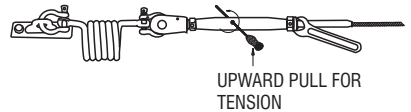

#### STEP 3: INTERMEDIATE; Ref. AFF111510

- Insert the cable through intermediate
- Connect the intermediate to the receiving structure with fastener.
- The angle of the Intermediate may be changed by inserting intermediate fastener to different holes provided.

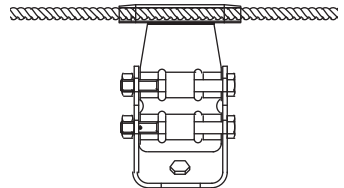

## CARRIAGE BODY

Ref. AFF4000 Roof Mounted, Wall & Ceiling Mounted

### CONNECTING PICTURE OF CARRIAGE BODY

Ref. AFF119000

- To connect the line to the user, there is a freely moving Carriage Body AFF119000, which moves along the length of the line with the user, who is connected to it by using a karabiner followed by a Connecting element connected to the full body harness of the user.
- The carriage body may be attached or detached from the line at any given point by two consecutive deliberate action. This is suitable for over head / over the roof application single as well as multi span systems.

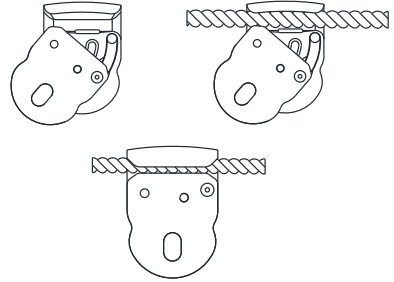

### RECOMMENDED PPE:



## 9. VERTICAL ANCHORAGE LIFE LINE SYSTEM

Ref. AFF8000 & AFF9000



Conforms to: EN353-1:2014 + A1:2017



**Aluminium Rail Extremity**

Ref. AFF531700



**Aluminum Rail Intermediate**

Ref. AFF531000



**Rung Clamp**

Ref. AFF533500

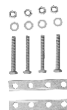

**Junction**

Ref. AFF533000



**Mounting Nut**

Ref. AFF533790



**Ceiling Mounting Bracket**

Ref. AFF533700

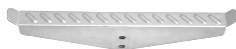

**Ladder Rung**

Ref. AFF532000



**Ladder Rung Left**

Ref. AFF532100



**Ladder Rung Right**

Ref. AFF532200



**Alu. Extension**

Ref. AFF531500



**Karabiner**

Ref. AFC601101



**Vertical Trolley**

Ref. AFF539000



## MOUNTING BRACKET

Ref. AFF8000 & AFF9000

### STEP 1: INSTALLATION OF MOUNTING NUT AFF533790

- Insert the mounting nut into the rail extremity. The first mounting nut must be at 300mm from the bottom edge and second needs to be 1500mm from the first mounting nut and so on.

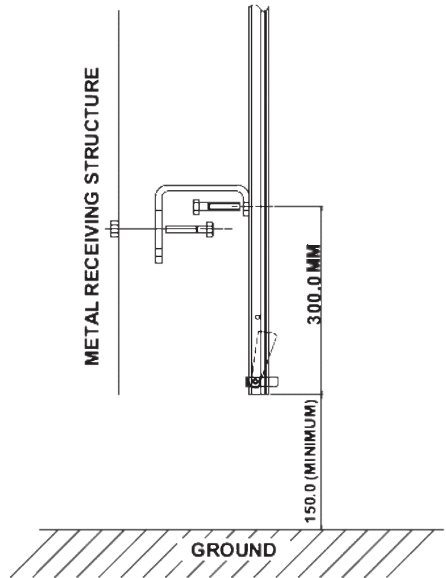
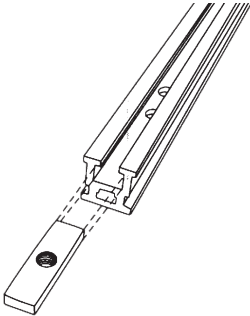

### STEP 2: INSTALLATION OF ALUMINIUM RAIL EXTREMITY AFF531700 & MOUNTING BRACKET AFF533700

- The Mounting Brackets can be installed on metal as well as concrete structure by special fasteners. Chemical fasteners are used to fix the brackets to the concrete wall and Stainless Steel fasteners for metal structure. The shorter end of the bracket is mounted on the rail by mounting nut and longer end to the receiving structure by using fasteners. Refer to Hilti HVU installation guide for Chemical fasteners.

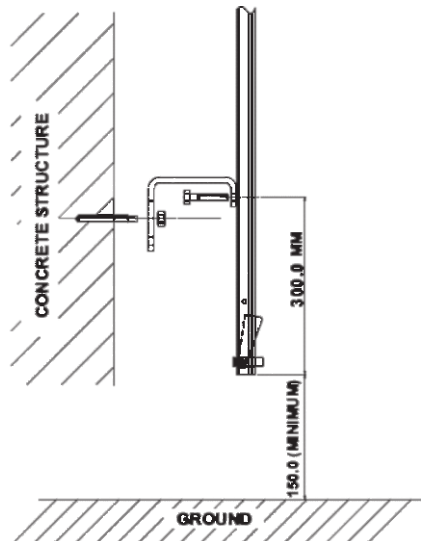



## JUNCTION & ALUMINUM RAIL EXTREMITY

Ref. AFF8000 & AFF9000

### STEP 3: INSTALLATION OF ALUMINUM RAIL EXTREMITY AFF531700

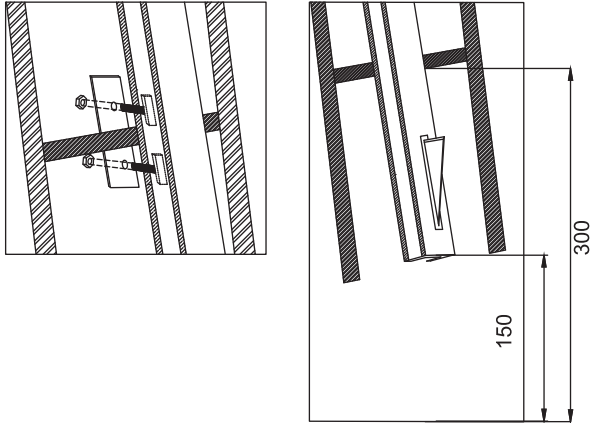

### STEP 4: JUNCTION: Ref. AFF533000

- Join two lengths of the rail intermediates. Match the sections of both rails. Place the junction plate on either side of the rail with the holes of the junction plate matching those of the rail intermediate.
- Fix both the plates by 4 sets of fasteners.
- Ensure that the gap between the two rails is not greater than 1.5 mm.

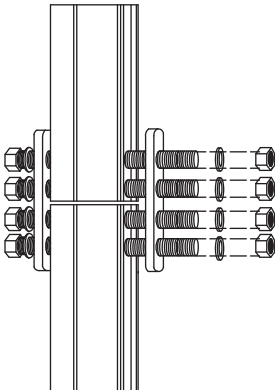

## ALUMINIUM RAIL EXTENSION & TROLLEY

Ref. AFF8000 & AFF9000

### STEP 5: INSTALLATION OF ALUMINIUM RAIL EXTENSION AFF533500

- Repeat step 2 to join the rail extension with the rail Intermediate.
- Select the correct rail extension Support depending upon the type of roof
- Connect the rail extension support to the end of the rail extension using a mounting nut.
- For trapezoidal roof sheets use blind rivets to install the rail extension support to the roof for standing seam fasten the bracket using nut bolts

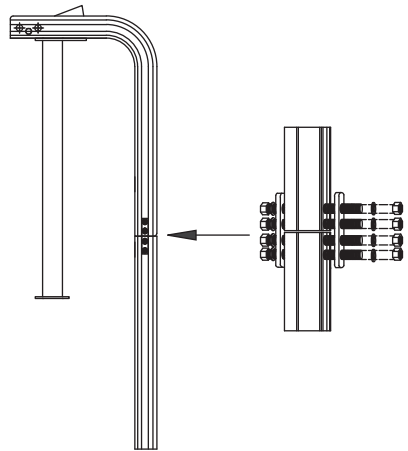

### STEP 6: VERTICAL TROLLEY: Ref. AFF539000

- Insert the trolley in the rail extremity. Press the termination of the extremity and pass the trolley over the termination.
- After the trolley slides on the Aluminum Rail the termination comes back to its original position ensuring that the trolley does not slide off the rail.

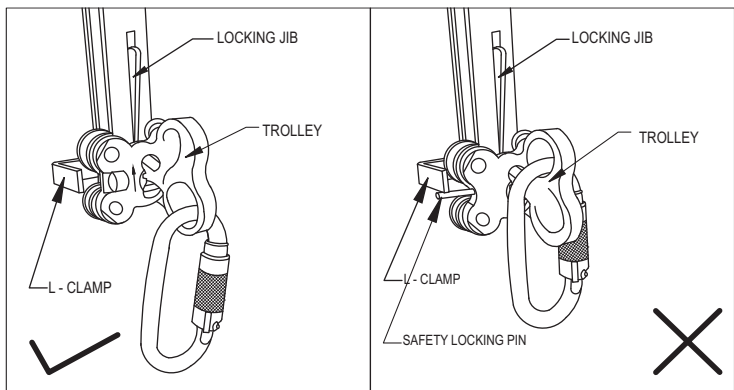

## RUNGS, HALF AND FULL

Ref. AFF8000 & AFF9000

### STEP 1: INSTALLATION OF LADDER RUNG LEFT/RIGHT AFF532100/ AFF532200

- The rail has two holes at regular intervals to hold the rungs, insert the bolt along with washer into the rung and tighten it

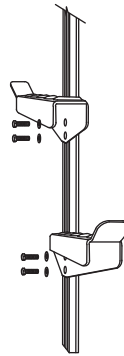

### RECOMMENDED PPE



## 10. HORIZONTAL ALUMINUM RAIL SYSTEM

### Ref. AFF5000

Conforms to  
EN 795:2012 Type D

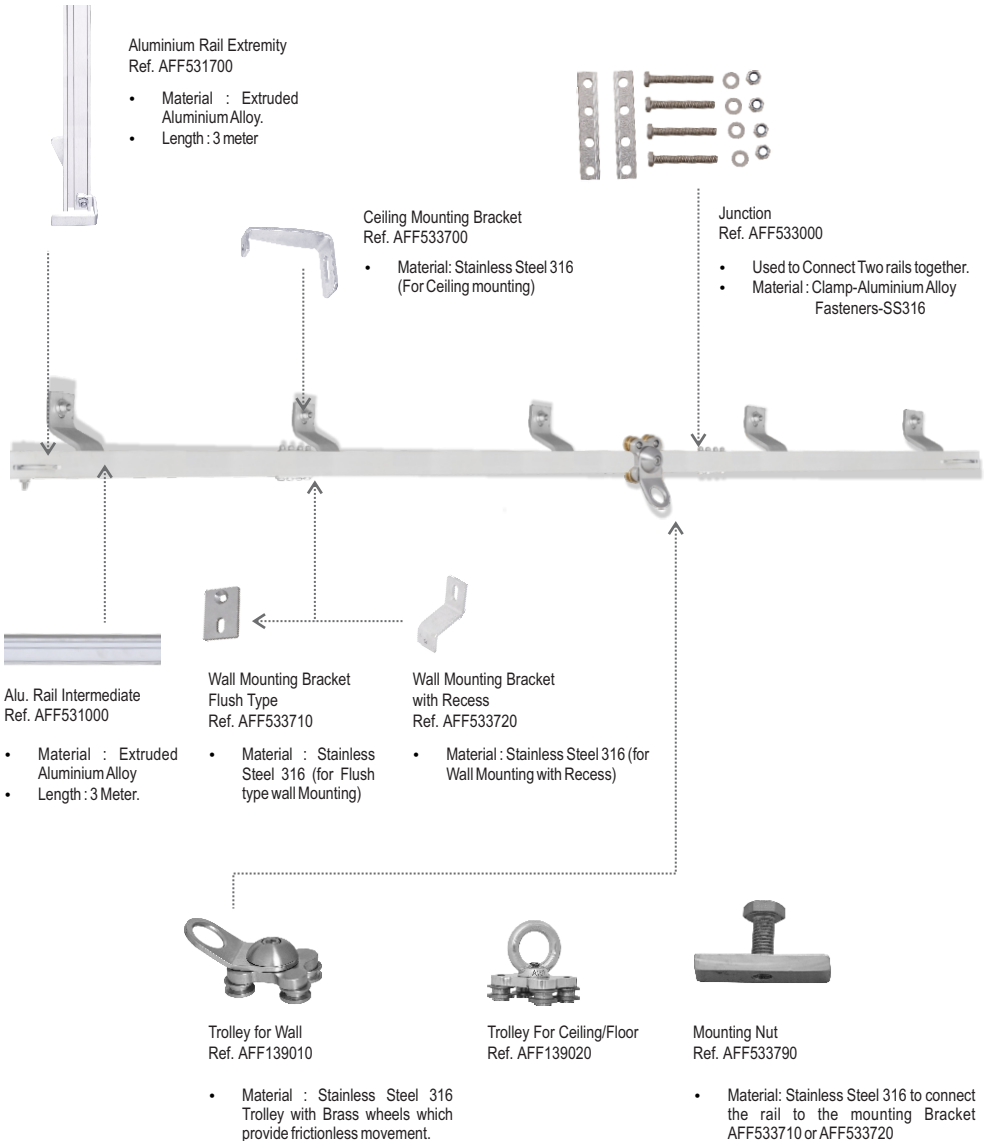

## MOUNTING NUT & MOUNTING BRACKET

Ref. AFF5000

### STEP 1: MOUNTING NUT Ref. AFF533790

- Insert the mounting nut in the channel as shown in the drawing. The mounting brackets may then be connected to the rail by a fastener.

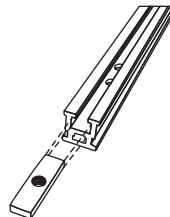

### STEP 2A: WALL MOUNTING BRACKET FLUSH TYPE: Ref. AFF133710

- Connect the bracket to the mounting nut as shown in the drawing.
- To install the mounting bracket in concrete use M12 Chemical fasteners. Refer to Hilti HVU installation guide.

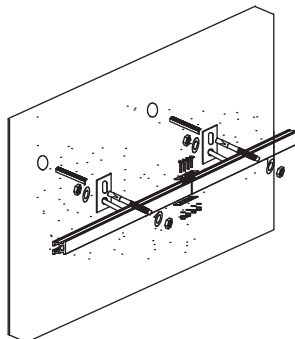

### STEP 2B: WALL MOUNTING BRACKET WITH RECESS: Ref. AFF133720

- Connect the bracket to the mounting nut as shown in the drawing.
- To install the mounting bracket in concrete use M12 Chemical fasteners. Refer to Hilti HVU installation guide.

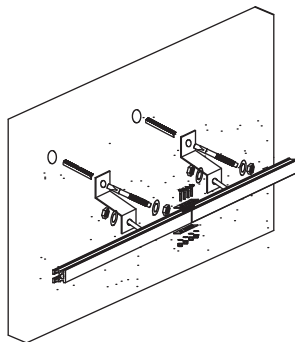

### STEP 2C: CEILING MOUNTING BRACKET: Ref. AFF533700

- Connect the bracket to the mounting nut as shown in the drawing.
- To install the mounting bracket in concrete use M12 Chemical fasteners. Refer to Hilti HVU installation guide.

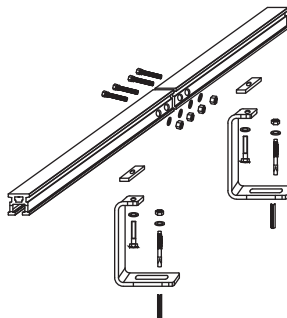

## BEND

Ref. AFF5000

### STEP 3A: CURVED ALUMINUM RAIL (OUTER WALL MOUNTED): Ref. AFF131010

- Join the curved rail with the intermediate. Match both sections of the rail.
- Place the junction plate on either side of the rail with the holes of junction plate matching with those of rail intermediate and curved rail.
- Fix both the plates by using 4 sets of fasteners.
- Ensure that the gap between the two rails is not greater than 1.5 mm.

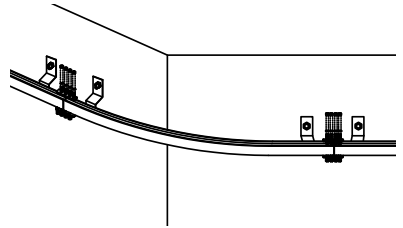

### STEP 3B: CURVED ALUMINUM RAIL (INNER WALL MOUNTED): Ref. AFF131020

- Join the curved rail with the rail intermediate. Match both sections of the rail.
- Place the junction plate on either side of the rail with the holes of junction plate matching with those of rail intermediate and curved rail.
- Fix both the plates by 4 sets of fasteners.
- Ensure that the gap between the two rails is not greater than 1.5 mm.

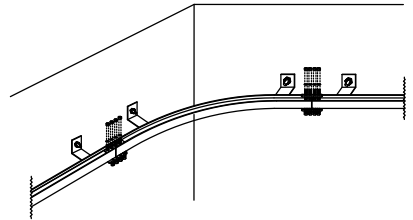

### STEP 3C: CURVED ALUMINUM RAIL (FLOOR/CEILING): Ref. AFF131030

- Join the curved rail with the rail intermediate. Match both sections of the rail.
- Place the junction plate on either side of the rail, with the holes of junction plate matching with those of rail intermediate and curved rail.
- fix both the plates by 4 sets of fasteners.
- Ensure that the gap between the two rails is not greater than 1.5 mm.

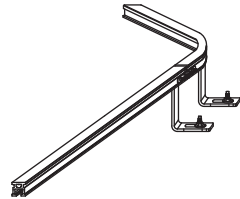

## TROLLEY & RECOMMENDED PPE

### Ref. AFF5000

#### STEP 4A: TROLLEY FOR WALL Ref. AFF139010

- Insert the trolley in the Aluminium Rail extremity. Press the termination of the extremity and pass the trolley over the termination.
- After the trolley slides on the Aluminium Rail the termination comes back to its original position ensuring that the trolley does not slide off the Aluminium Rail.

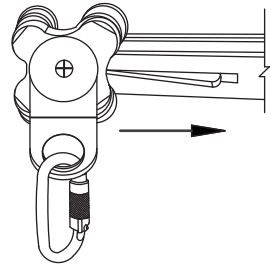

#### STEP 4B: TROLLEY FOR CEILING/FLOOR: Ref. AFF139020

- Insert the trolley in the Aluminium Rail extremity. Press the termination of the extremity and pass the trolley over the termination.
- After the trolley slides on the Aluminium Rail the termination comes back to its original position ensuring that the trolley does not slide off the Aluminium Rail.

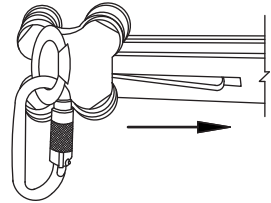

### RECOMMENDED PPE



## 11. PROOF LOADING

### PROCESS OF PROOF LOADING OF HORIZONTAL AND VERTICAL LIFE LINES

- The cable termination may be proof loaded upto 6kN using hydra jaws testing equipment.
- The hydra jaws equipment pulls the wire out of the termination using a hydraulic cylinder.
- The pull force is increased to 6kN and the pressure gauge mounted on the cylinder displays the exact tension achieved. Once 6kN is achieved the tension is released.
- Now we know that the cable termination is successful



HYDRA JAWS LIFELINE TESTING

## 12. PRE-USE CHECKS

### Checks and Precautions

- **Post Installation Inspection**
  - Once installed, it is important to inspect the complete line by moving along the entire length of life line.
  - On site testing of the receiving structure may be provided at an extra cost.
- **Pre Use-check Guidelines**
  - It is mandatory for the Site Inspector/ Supervisor and the actual users to conduct a thorough check of the system before carrying out work. KStrong conducts a brief training of all concerned personnel on the subject of Pre-Use Inspection of the System as per a defined guideline after the system has been installed by KStrong personnel.
- **Checking the Receiving Structure**
  - Do not use the system if receiving structure is found weak.
- **Checking the System**
  - Check any sag in the system.
  - Check any deployment in the shock absorber.
  - Check the lock nuts of tensioner.
  - Check the proper working and condition of PPE.
  - Clean the system from dust/dirt. Check for any mechanical defects.
  - Check for wear and tear in all components or unusual bending or deformation.
  - Check for any modifications done by the user.
  - Check for any missing component.
  - Check for any damages that may have been caused due to welding while maintenance of other equipment.
  - Check the Identification Plate. The system needs to be put out of service if the label is not legible or missing.
- **Checking the Cable**
  - See that there is sufficient tension on the cable by checking the tension indicator in the shock absorber.
  - Check the condition of the cable. Wear hand gloves and check the wire from all sides. Check for broken strands or any deformity in the cable. Report if strands are found broken.



## 13. PRECAUTIONS WHILE USING Precautions While Using The System

### • The Following Points of Precautions Needs to Be Considered for Safe Use of the Fixed Line Systems

- The life line is for the purpose of fall protection while working at height. A back up fall arrest system is required when transitioning on and off the life line system .
- Never disengage the fall arresting lanyard from the life line while working at height.
- Avoid using grease to lubricate the system. If any fall is reported, Tag the system out of use. Contact the manufacturer for repairs and re-validation.
- Only certified KStrong full body harness with proper attachment anchorage points should be worn while using KStrong Fixed Line Systems.
- Do not alter or misuse this equipment. Always take an advice from KStrong personnel while using this equipment in combination with components or subsystems other than those described in this manual. Usage of certain component/sub system may interfere with the proper functioning of this equipment and the system may not deliver the working as per its intended use. In such case KStrong may not be held responsible for any malfunction.
- The lifelines must be kept free from dust, grease etc., by periodic cleaning. The system can be cleaned by a soft dry cloth.

### • Hazards

- Hazards existing in immediate environment may require additional precautions to limit the possibility of injury to the user or damage to the equipment. Hazards may include but are not limited to, extreme temperatures, caustic chemicals, corrosive environments, high voltage power lines, explosive or toxic gases, moving machinery, sharp edges, high velocity winds Etc. Do not expose the equipment to any hazard for which it is not designed to withstand. Consult the manufacturer if in doubt.

### • Rescue Plan

- It is mandatory to ensure that the user shall have a rescue plan and means to execute it while using this equipment. The rescue plan needs to be project specific. The employees must be trained in self-rescue or alternative means shall be provided for prompt rescue in an event of a fall.
- Always work in a pair to ensure that in an event of a fall your partner may help in rescue

### WARNINGS:

- Ensure the Medical condition of the user does not affect his safety in normal and emergency use.
- The equipment shall only be used by a person trained and competent in its safe use.
- A rescue plan shall be in place to deal with any emergencies that could arise during the work.
- Ensure that the anchor is installed directly above the user's head.
- It is essential to verify free space required beneath the user at work place before each occasion of use so that in case of a fall there will be no collision with ground or other obstacle in the fall path.
- Do not make any alterations or additions to the equipment without the manufacturer's prior written consent and that any repair shall only be carried out by personnel trained by the manufacturer & duly authorized personal.
- The equipment shall not be used out side its limitation, or for any purpose other than that for which it is intended.
- It should be the personal property of its user.
- Ensure that the equipment is compatible with other items when assembled into a system.
- It is important to check before use, any dangers that may arise by the use of combinations of items of the equipment in which the safe function of any one item is affected by or interferes with the safe function of another
- Carry out a Pre-Use check of the connectors, to ensure that it is in a serviceable condition and operates correctly before it is used. connectors should not have any cracks, deformation, damages or rusts and gate , lock should be moved freely.
- It is essential for the safety of the user that if the product is re-sold outside the original country of destination the reseller shall provide instructions for use, maintenance, periodic examination and for repair in the language of the country in which the product is to be used.
- Full body harness is the only acceptable body holding devices that can be used in a fall arrest system.

## 14. KStrong Compass App

Introducing KStrong Compass™, the fall protection industry's first "free at your fingertips" mobile application for fall protection equipment asset management. KStrong Compass™ is a cloud-based software app which relieves the user from a mountain of paper records. The unique AIR system (Automated Inspection Reminder system) reminds a user of a pending competent person inspection that is required to minimize accidents that may happen due to equipment that has not been properly inspected.

The KStrong Compass™ user management system allows equipment to be issued to individuals, thus ensuring accountability towards the upkeep of the equipment. The mobile app provides each user vital information on inspection and periodic maintenance needs and helps in increasing the life of the equipment. Using KStrong Compass™ is a wise decision to cut down costs on PPE.



**15. TOOLS**



**RING SPANNER**



**DOUBLE END SPANNER**



**SOCKET SET**



**TENSIONER TIGHTENING TOOL**



**CRIMPING PLIER**



**BOLT CUTTER**



**ALLEN KEY**

**MACHINES**



**CORDLESS DRILL MACHINE**



**HAMMER DRILL MACHINE**



**CORDLESS IMPACT WRINCH**



**HYDRA JAWS  
LIFELINE TESTING**



**SWAGING TOOL**



**HYDRAULIC CRIMPING HEAD**



**POWER BIRD RIVETING MACHINE**

**ANCHORS**

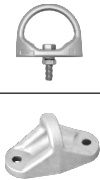

**MEASURING TOOLS**

					
TAPE	DETECTOR	DIGITAL TORQUE WRENCH	DISTANCE METER	LASER TOOL	VERNIER

**CONSUMABLES, MISCELLANEOUS TOOLS**

						
DUST PUMP	HOLE SAW CUTTER	HOT AIR GUN	SETTING TOOL	PAINT BRUSH	DRILL BIT	IMPACT DRILL
						
BLOWER	CHEMICAL APPLICATOR					

WRENCH SIZE					
Hex Bolt	6	8	10	12	16
Wrench Size	10	13	16	19	24
Socket Size	10	13	16	19	24

ALLEN KEY SIZE				
Allen Bolt Size	6	8	10	12
Allen Key Size	4	6	8	10
Allen Grub Screw Key Size	3	4	5	6

**15. TORQUE CHART**

CHART						
Bolt size	6 mm	8 mm	10 mm	12 mm	14 mm	16 mm
Recommended Torque:	9 Nm	22 Nm	29 Nm	50 Nm	80 Nm	125 Nm

**LIFESPAN:** The estimated product Lifespan is 20 years from the date of manufacture. The following factors can reduce the Lifespan of the product: intense use, contact with chemical substances, specially aggressive environments, extreme temperature exposure, UV exposure, abrasions, cuts, violent impacts, bad use or lack of maintenance.

**DISCLAIMER:** Prior to use, the end user must read and understand the manufacturer's instructions supplied with this product at the time of shipment and seek training from their employer's trained personnel on the proper usage of the product. Manufacturer is not liable or responsible for any loss, damage or injury caused or incurred by any person on grounds of improper usage or installation of this product.

<b>EQUIPMENT RECORD</b>				
Product				
Model & type/Identification		Trade Name	Identification number	
Manufacturer		Address	Tel, email into use	
Year of manufacture		Purchase Date	Date first put into use	
Other relevant information (eg. document number)				
<b>PERIODIC EXAMINATION AND REPAIR HISTORY</b>				
Date	Reason for entry (periodic examination or repair)	Defects noted, repairs carried out and other relevant information	Name and signature of competent person	Periodic examination next due date

**Certification Body :**

SATRA Technology Europe Ltd, Bracetown Business Park, Clonee, Dublin D15 YN2P Ireland (Notified Body 2777)

**Ongoing Assessment Body:**

SGS Fimko Oy, Takomotie 8, FI-00380 Helsinki, Finland (Notified Body 0598)

For EU Declaration, please visit on <https://kstrong.com/asia/eu-declaration-form/>



KStrong Inc.  
150 N. Radnor Chester Road Suite F200  
Radnor, Pennsylvania 19087 United States  
Contact Email: [customercare@kstrong.com](mailto:customercare@kstrong.com)

[www.kstrong.com](http://www.kstrong.com)

USA	South America	ASIA
-----	---------------	------