



## Evac R+

---

USER INSTRUCTION MANUAL  
**DESCENDER, RESCUE AND LIFTING DEVICE**

THESE INSTRUCTIONS APPLY TO THE FOLLOWING MODELS:

AFX209070

ANSI Z359.4:2013 (2 Persons)  
EN 341:2011 – 1A (2 Persons)  
EN 341:2011 – 1B (3 Persons)  
EN 1496:2017 - B  
EN 12841 Type C



**Dear customer,**

Congratulations on purchasing this product. It was manufactured and tested subject to strict quality standards and with the utmost care. We thus laid the groundwork for safe use. It is now your responsibility to use this product correctly.



For correct and safe use of this product it is essential that you read these instructions carefully. Follow all safety instructions in the respective chapters of this manual.

You may only use this product if you have read and understood these instructions for use, if you have undergone training and if you are physically and mentally capable of doing so.

This manual including the inspection protocol must be kept with the product. In case of loss or if manual and inspection protocol became unusable, the effective versions of both documents are available for download at [www.kstrong.com](http://www.kstrong.com)

**Country of origin**

Austria / Europe

## TERMINOLOGY

COMPETENT PERSON	trained according to DGUV 312-906 or with appropriate regional training
AUTHORIZED PARTNER	trained by KStrong. The authorized partner is authorized to perform inspections and maintenance of the product.
RESCUE / DESCENDER DEVICE	Evac R+ incl. rope
ANCHOR DEVICE	Suitable anchor devices corresponding to the applicable standards for PPE against falls from a height.

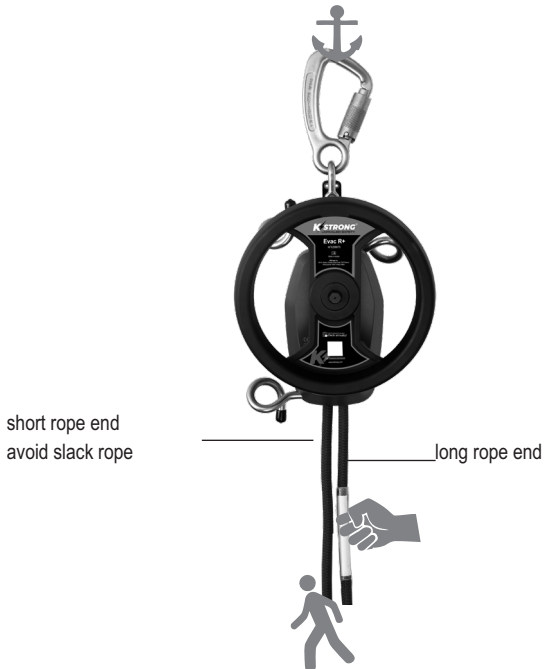

### ! NOTE

The shown pictures are examples and symbol photos. The actual devices may vary a little because of options (connectors, hand-wheel,...).

## 1 FOR YOUR OWN SAFETY

Activities requiring the use of this product can be dangerous. Moreover, it is also possible to use this product incorrectly in many ways and we cannot possibly list or think of all of them.

These instructions for use will give you information on your safety and the product and its use. This information and the safety instructions do not however replace personal experience, knowledge of the product and self-responsibility.

You will find detailed safety regulations and descriptions in the following chapter and at the beginning of each chapter. Read them carefully and make sure you understand them. If you need more information or if you are not sure how to use this product, get in touch with KStrong. We will be happy to help you.

This product is state of the art and corresponds to all applicable technical standards and guidelines.

### 1.1 Symbols used

In this document safety regulations of the following categories are being used:

**DANGER, WARNING, CAUTION** and **NOTE**. Follow the safety instructions to avoid personal injuries or damage of the product.



**DANGER**

**DANGER** means that death or a serious injury is very likely to happen if an accident occurs or a hazardous situation is not avoided.

- In order to avoid serious injury or death all safety instructions marked with **DANGER** must be followed.



**WARNING**

**WARNING** means that death or a serious injury is likely to happen if an accident occurs or a hazardous situation is not avoided.

- In order to avoid serious injury or death all safety instructions marked with **WARNING** must be followed.



**CAUTION**

**CAUTION** means that moderate or minor injuries may happen if an accident occurs or a hazardous situation is not avoided.

- In order to avoid moderate or minor injuries all safety instructions marked with **CAUTION** must be followed.



**NOTE**

**NOTE** draws your attention to a possible damage of the product or other properties if an accident occurs or a hazardous situation is not avoided.

- In order to avoid damage of the product or other properties all safety instructions marked with **NOTE** must be followed.

## 1.2 User requirements

- Read these instructions for use thoroughly before using this product. You can only use this product after you have read and understood these instructions for use.
- This product can only be used as a descender and rescue device or for work positioning according to EN 12841-C for persons.
- This product can only be used by max. two persons at a time.
- You can only use this product if you are mentally and physically capable of doing so.
- PPE equipment is meant as personal equipment for every user.

## 1.3 Visual and functional inspection

- The annual visual and functional inspection must be carried out by KStrong or an authorized partner. KStrong offers trainings for that purpose.
- This product must be inspected (e.g. damage of the rope etc.) before and after its use by the user.
- If the product has been subjected to heavy loads (e.g. due to a fall) , it must be sent to KStrong or Authorized service agent for inspection. Don't forget to give us all necessary information (where and how this product has been damaged).
- If the use of this product does not seem safe anymore (e.g. rope damaged etc.), send it to KStrong or an authorized partner for inspection and repair. Do not use it!
- Fill in the inspection protocol carefully. Each inspection must be entered.

## 1.4 Use

- The lifetime of metal parts of this product is unlimited. Textile components (e.g. ropes and lanyards) must be replaced after, maximum, 10 years after production.
- This product will heat up during the descent. Touching the housing or holding the long rope end during descent may lead to burns.
- If sharp edges (radius < 3mm) cannot be avoided, always use a protecting shield to protect the rope from damage or breaking.
- Always fix this product to an anchor device according to EN 795 before descending.
- Do not guide the loaded rope end through the eye bolts. This would stop the descent.
- This product can only be used in combination with tested and certified products (according to applicable standards for PPE against falls from a height).
- You can only resell this product when accompanied by the instructions for use in the respective language of the country and the complete inspection protocol.
- The use protocol must be filled in after each use.
- Descending and rescue devices, which are stored at the working side, have to be covered against environmental influences.

### **1.5 Storage and transport**

- Store this product in a dry and clean place protected from mechanical (e.g. sharp edges) and chemical hazards (e.g. acids, gas) at room temperature and protected from light (e.g. UV).
- Store and transport this product in the original or an equivalent packaging. Store the rope loosely in figure of eight loops to avoid knots, which may result in blocking the device.

### **1.6 Maintenance**

- Repairs may only be effected by KStrong or an authorized partner.
- If this product has been subject to a fall, all parts must be inspected and, if necessary, be replaced by KStrong.
- This product must not be tumble-dried, dried in the sun or over a heat source (e.g. radiator) -> Air-dry this product in an airy, shaded place.
- This product (the rope in particular) must not be disinfected or impregnated.
- Do not use chemicals when cleaning the product.
- This product must be inspected by KStrong or an authorized partner at least once a year. But in any case after maximum descent distance written on page 8. Enter the distance in the use protocol.

### **1.7 Accidents and rescue plan**

- A suspension trauma can be triggered by falling into the rope, a long descent or if a person is helplessly suspended in the harness for a long time.
- Prepare a rescue plan indicating all possible rescue measures in case of emergency before using this product.
- Check the use and fall area and make sure to secure, mitigate or remove possible dangers before using this product.

## 2 PRODUCT OVERVIEW

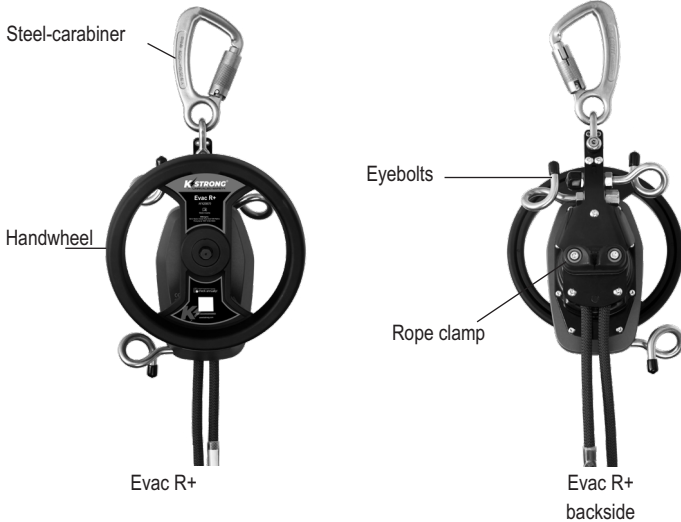

### 2.1 Technical details

- Certified according to EN 341:2011 Klasse 1A (2 persons), EN 341: 2011 Klasse 1B (3 persons), EN 1496:2017 Klasse B (3 persons), ANSI Z359.4:2013 (2 persons), EN 12841:2006 Typ C (1 person)
- Weight (without rope): 3,75kg
- Rope for EN 341, EN 1496 und ANSI Z359.4:2013: Kernmantlerope Ø10,5mm (EN 1891 A)
- Rope for EN 12841: Kernmantleropel Ø9,6mm till Ø11mm (EN 1891 A)
- Descent / lifting load max. 300kg/min. 30kg (EN: 3 persons / ANSI: 2 persons)
- Descent / lifting height max. 500 m
- Descent speed approx. 1,0 m/s with 85kg and approx. 1,5 m/s with 170kg
- Motorized lifting possible with a cordless screwdriver
- Descent controllable by means of a rope deflection using the eye bolts
- Ambient temperature -40°C to +65°C
- The device can be used in both directions for descending and abseiling



## 2.2 Marking

This product has a serial number engraved in the housing. You will also find the serial on the first page of these instructions for use.

- 1 CE marking of the supervisory authority
- 2 Perform an inspection regularly / at least once a year
- 3 Max. Number of people with simultaneous use
- 4 Max. Descent height acc. standard (multiple use)
- 5 UID for traceability
- 6 Production year and months
- 7 Product name
- 8 Manufacturer
- 9 Always read and follow the instructions for use!
- 10 Warning: hot surface
- 11 Avoid descending into electrical, thermal, chemical or other hazardous areas
- 12 Application temperature range
- 13 Max. and min. rated load
- 14 Compatible rope sizes and types
- 15 Harmonized standards

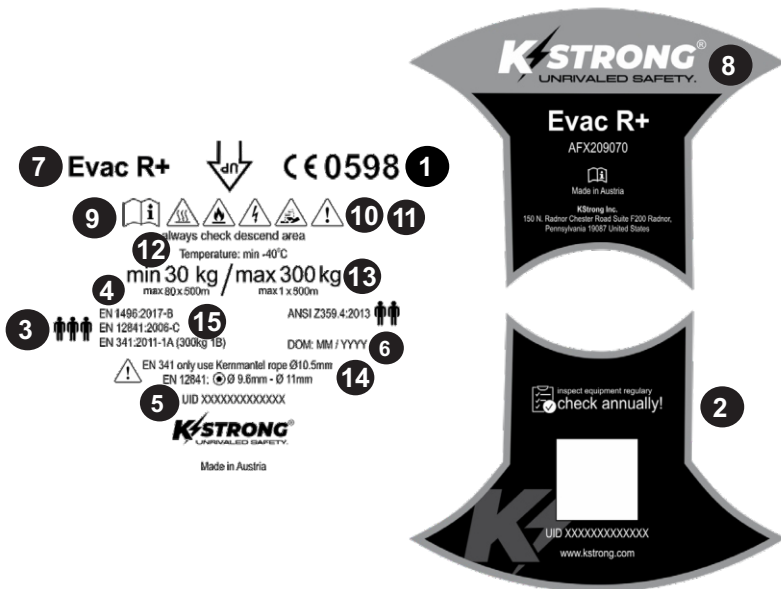

## Rope marking

EN standard  
Diameter and  
length of rope

EN1891A:1998 - 10,5mm - L: 10m  
MM/JJ: 11/20 - KStrong

Date of production, Manu-  
facturer

- Use an inventory number for this product. Enter the inventory number in the inspection protocol.
- Do not remove labels or other markings from this product.

### 2.3 Scope of delivery

- 1 pc Evac R+
- 1 pc rope inserted in the housing (length acc. to order)
- 1 pc packaging
- 1 pc instructions for use incl. inspection and use protocol

### 2.4 Accessories

**This product can only be used in combination with tested and certified products.**

- Only use this product with tested products or with products that have been recommended by KStrong. The following products correspond to the applicable PPE against falls from a height standards.

#### Tested and certified products

Rescue overall/harness	EN 1497
Energy absorber	EN 355
Carabiner	EN 362
Anchor device	EN 795
Full body harness	EN 361
Lanyards	EN 354
Workpositioning	EN 358

The above products are featured on [www.kstrong.com](http://www.kstrong.com). If you need more information please send us an email or call us.

### 2.5 Maximum descent distance recommended by the manufacturer

- max. descent distance with 1 person up to a max. of 75 kg: 10000m
- max. descent distance with 1 person up to a max. of 100 kg: 7500 m
- max. descent distance with 1 or 2 persons up to a max. of 150 kg: 5000 m
- max. descent distance with 2 persons up to a max. of 225 kg: 3500m
- max. descent distance with 3 persons up to a max. of 300 kg: 500m

You can reduce the load on the device through redirection (see 3.3).



## 2.6 Redundancy

A training is not an emergency! At every training situations as well as rope access a redundant safety system has to be installed. Unforeseen events, technical or human failure cannot be ruled out. For redundancy safety measures you can also use a second Evac R+.

## 2.7 Rescue deployment

After each rescue deployment the device has to be inspected by KStrong or an authorized partner in order to ensure safe use. We recommend using different devices for training and rescue deployments.

## 2.8 Overload

Devices that have been subjected to a fall or a heavy load must be retired.



Rope clamp: When you activate the rope clamp, the hand wheel can only be turned in one direction. Turn the hand wheel gently to figure out the direction in which you can turn the wheel.  
Danger: If you turn the hand wheel in the wrong (blocked) direction, the wheel or the device can be damaged. In that case, the device has to be inspected by KStrong or by an authorized partner.

## 2.9 Temperature

This product can be used in environments between  $-40^{\circ}\text{C}$  and  $+65^{\circ}\text{C}$ .

### 3 USE

Activities requiring the use of this product can be dangerous. Please observe all danger and safety notes. In case of doubt or if you have any questions, please feel free to contact us.

#### 3.1 Intended use

**This product can only be used as a rescue, descender and lifting device and only for transporting persons.**

- This product can only be used for its intended purposes as defined in these instructions for use and only in combination with tested (certified) components according to the applicable PPE standards. Other combinations with uncertified components are not permitted and can be dangerous.

#### Use

**Using this product without having read these instructions for use can lead to accidents resulting in severe injuries or death.**

- Read these instructions for use carefully before using this product.
- In case of doubt or if you have questions please contact KStrong.

#### Inspection

**Using this product without having performed a visual and functional inspection can lead to accidents resulting in severe injuries or death.**

- Always inspect this product before and after its use.
- If you are not sure if this product can be used safely, do not use it.
- Let the device cool down to room temperature after driving 1,000,000 J .

#### Edge protection

**If the rope is guided over a sharp edge, it can be damaged.**

- Always use an edge protection (e.g. a protective plate) or a protective shield with sharp edges..

#### Risk of burns

**This product (housing and rope) will heat up during the descent. Risk of burns during longer descents.**

- Do not touch the housing during or after long descents.
- Do not hold on to the long rope end during descent.
- Wear protective gloves.

This product offers you a range of applications for various situations. Using this product requires solid training by professionals who have been trained on this product.



**DANGER**



**CAUTION**

### 3.2 Important notes on the usage of the eye bolts



Eye bolt

Shorter rope end, has to be tightened (no loose rope)

Longer rope end, runs through the eye bolt

Using the eye bolts, you can control the descent speed or stop the descent. The longer, unloaded rope end runs through the eye bolts. If you hold on to the longer rope end, you can throttle the descent speed or stop the descent. If you don't use the eye bolts, the descent speed will be regulated automatically by two fly wheel brakes (speed ca. 0.8m/sec)

If you are using the descender as a shuttle system, make sure that you use the eye bolts correctly.

**Standard rule: Only run the unloaded, longer rope end through the eye bolts!**



**CAUTION**

**Longer and shorter rope end**

**If you run the shorter rope end through the eye bolt (shorter rope end = loaded rope end, on which a person is suspended) the descent will be blocked and the person cannot be lowered to the ground.**

- Only run the longer, unloaded rope end through the eye bolts!

short rope end  
avoid slack rope



long rope end

**CORRECT**

### 3.3 Abseiling with Evac R+

#### 3.3.1 Simple Abseiling passive



**1**

Attach the rescue device to a proper anchor point.

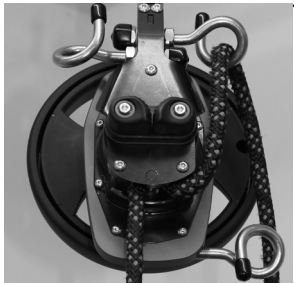

**2**

In both ways: using the eye bolt located on the side of the unloaded rope end will add friction when you hold back the unloaded rope end. This way you can reduce speed manually.

#### Use of the rope clamp

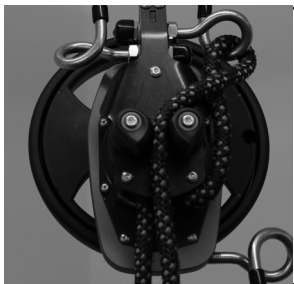

**1**

In both ways: you can block the device after stopping by running the rope out of the device making a U-turn to the eye bolt and back through the rope clamp as shown (grab the handwheel while doing this).

### 3.3.2 Simple Abseiling active

**1**

For ergonomic rope handling and to create additional friction use the third eye bolt. This way the rope runs from bottom to top.

**2**

You can block the device after stopping by running the rope out of the device making a U-turn to the eye bolt and back through the rope clamp as shown (grab the handwheel while doing this).

### 3.4 No move during lifting

If it happens that you no longer move during the lifting (caused by dirt, moisture, wear...on the rope) you only need to pull on the opposite rope. Afterwards the lifting process can continue smoothly.

#### 3.4.1 Preventing Rope Jam

Care must always be taken, especially when using a hoist, to pull the rope out of the device so that no rope jam can occur. The rope exit must also always be kept clear and must not be blocked by objects or structures.

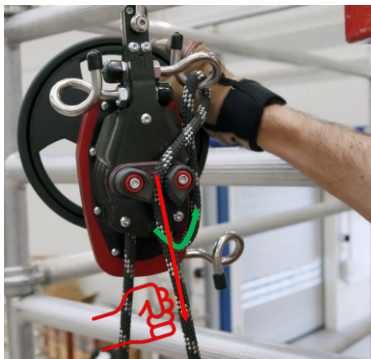

■ tighten    ■ outcoming rope

The rope must be tightened after a maximum of two turns of the handwheel in order to prevent a rope jam on the outcoming rope.



**WARNING**

3.5 Application under EN 12841

The following work steps on the device may only be carried out if the device is used in accordance with EN 12841!

3.5.1 - INSERT THE ROPE

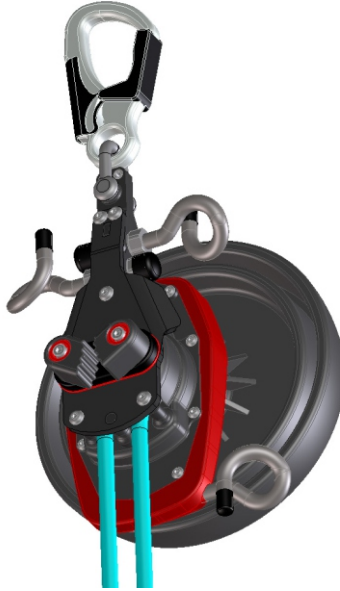

**Necessary tool :**



**Slotted screwdriver**



Method:

**1**

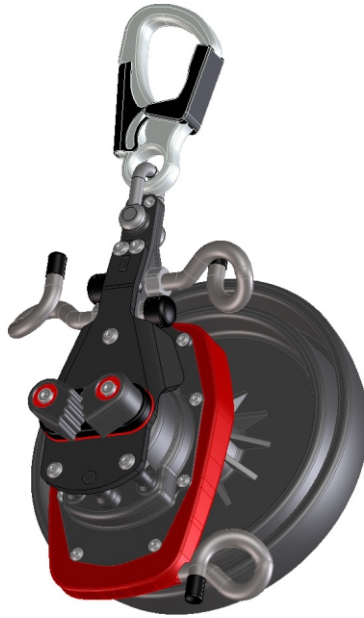

**2**

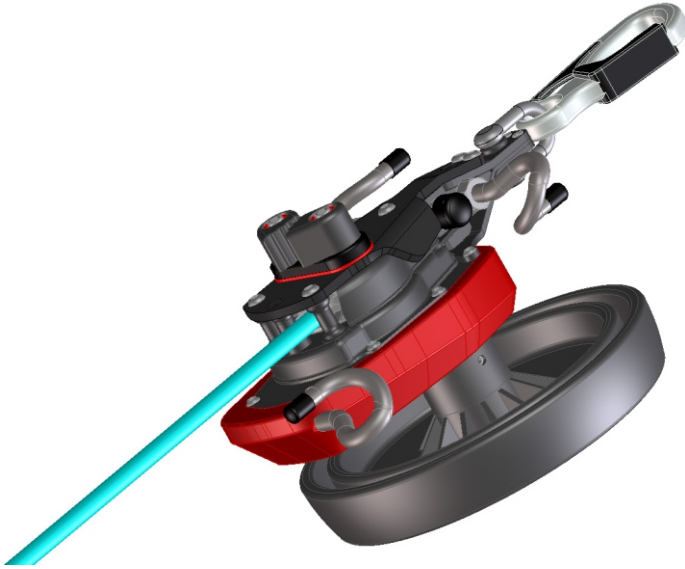

**3****4**

If you feel a counter-pressure when turning, the rope must be removed from the unit and re-threaded into the device. Repeat this process until the rope can be seen at the other end. You can now proceed as described in point 5.

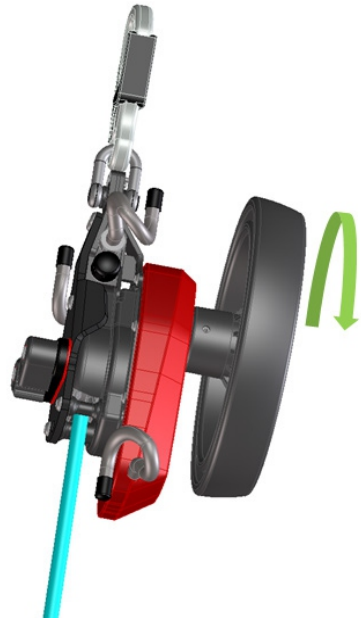

5

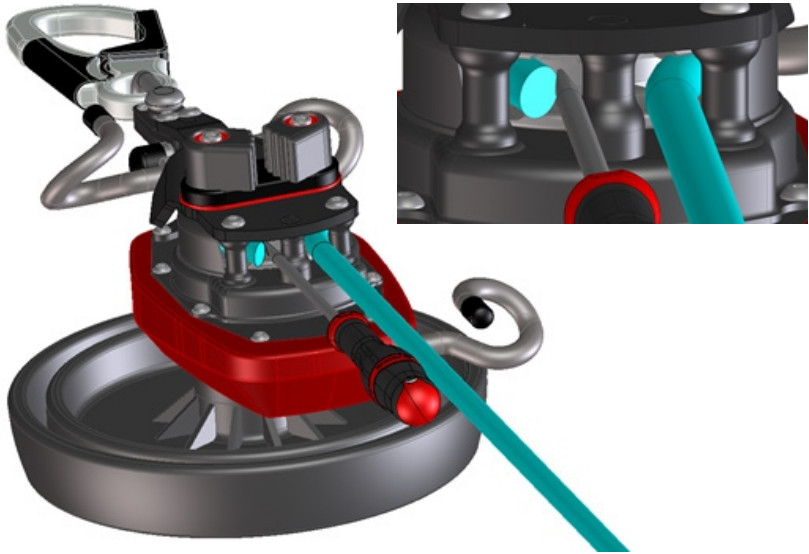

6



3.5.2- CHANGE THE ROPE GUIDE

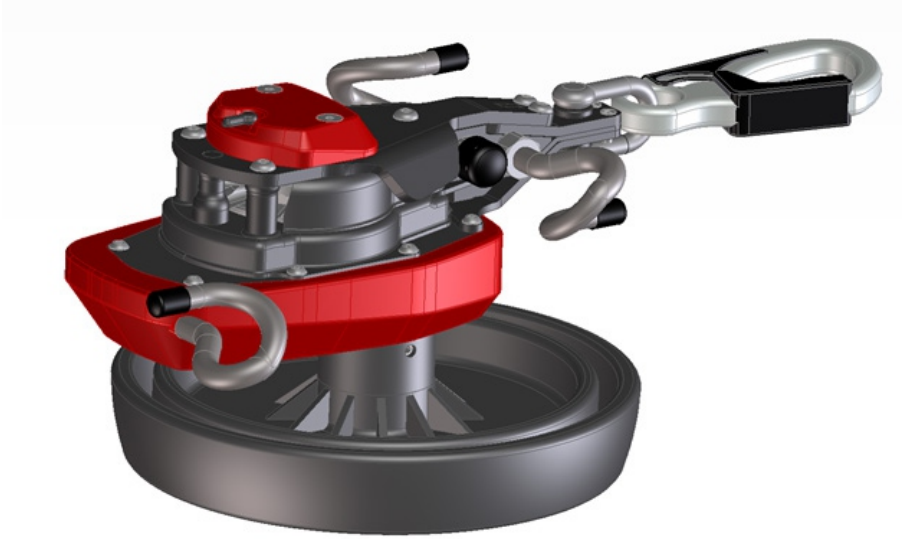

Necessary components: Set 14, Item number 86512



or



2 x

for rope Ø9,6-10,5mm

2 x

for rope Ø10,5-11mm

Method:

1

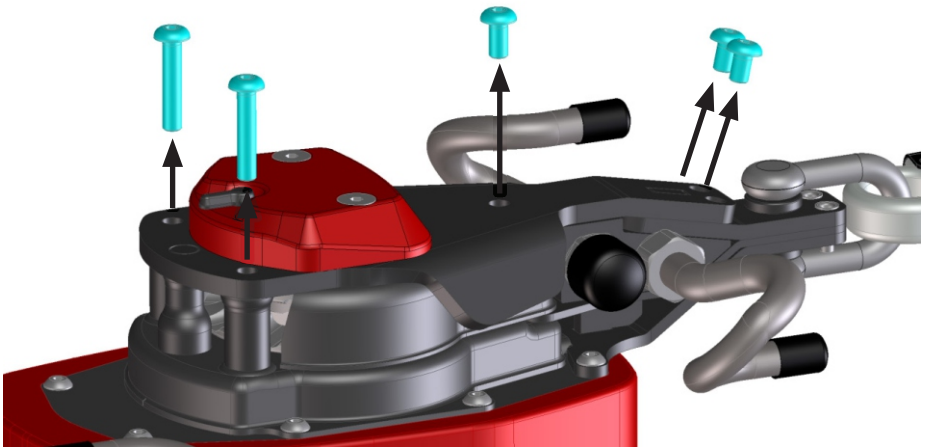

3

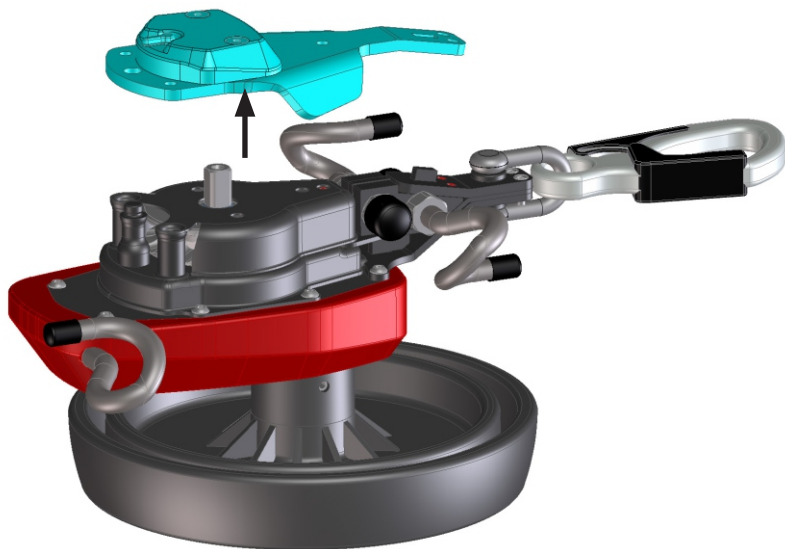

4

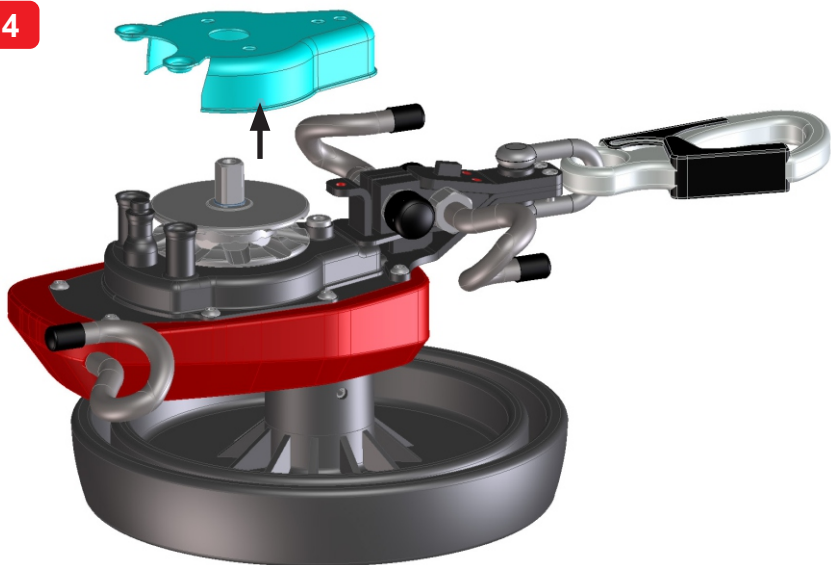

5

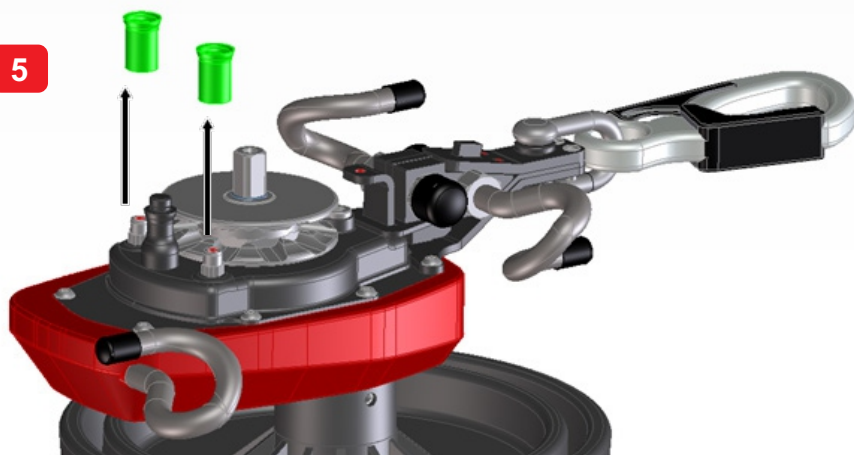

6



7

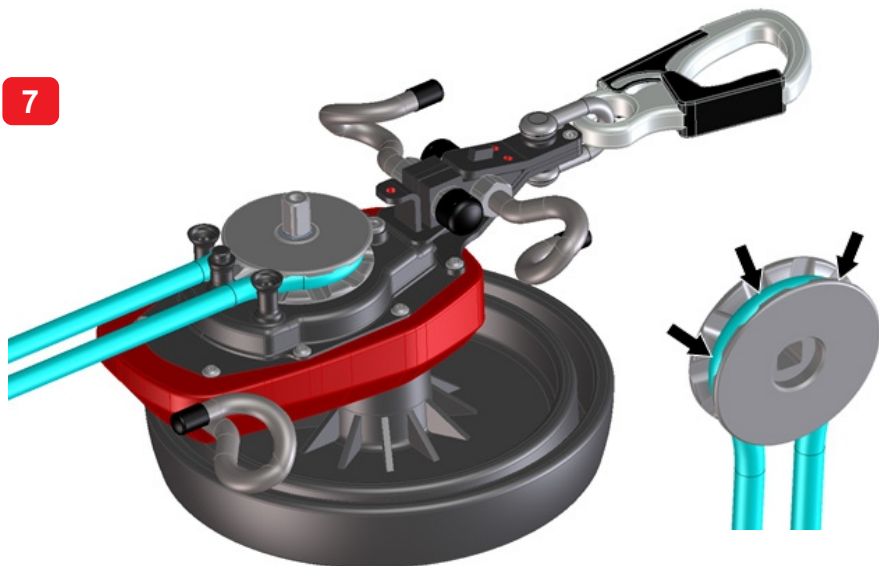

8

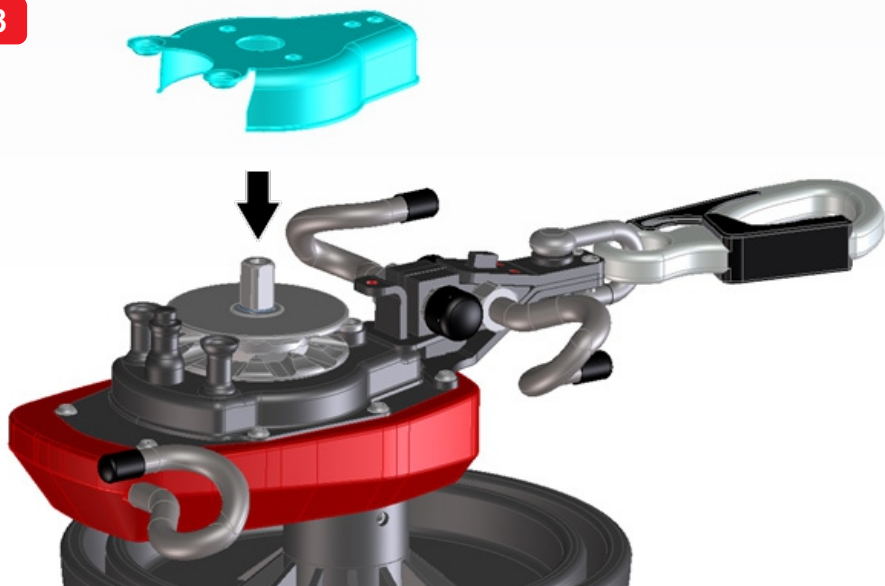



9

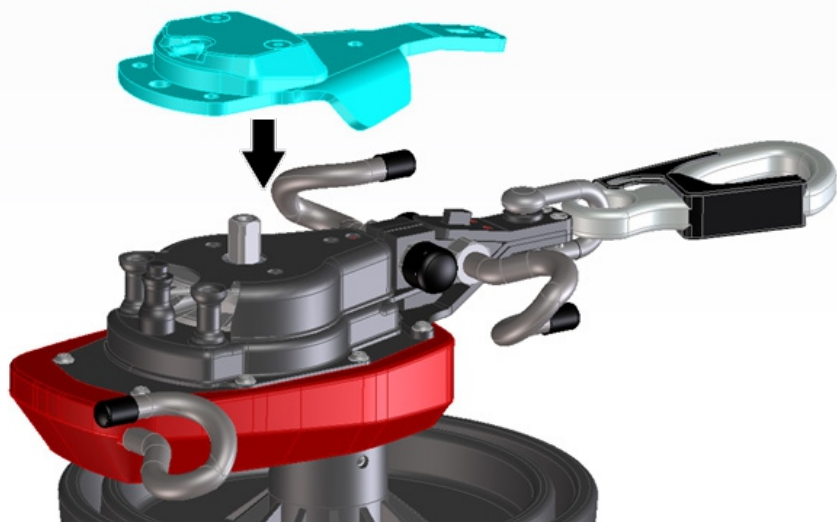

10

5 x 3,5Nm

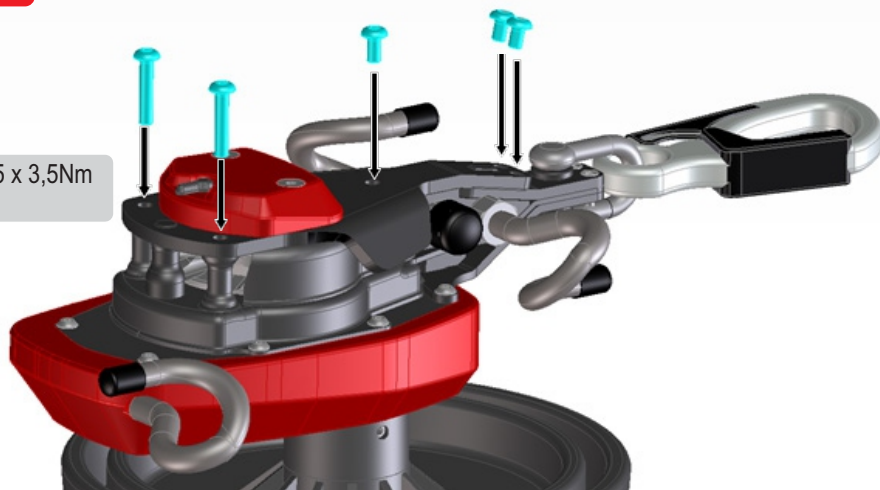



### 3.6 Anchor device

#### **Attachment on anchor device**

**Improper attachment on an anchor device may lead to fall resulting in severe injuries or death.**

- Inspect the anchor at least once a year.
- Only use anchors that correspond the requirements of PPE.

Anchor devices are necessary in places that present falling hazards (acc. to §72 AAV). The building planner/owner is responsible for the positioning and installation of anchor devices according to the applicable legal requirements, norm and rules.

Buildings and plant structures have to present appropriate load capacities. According to the applicable standards the following (static) loads are installed in the building.

- Restraint systems 4 kN
- Fall protection systems 12 kN

**On [www.kstrong.com](http://www.kstrong.com) you will find the following documents available for download:**

- instructions for use
- checklist for installation and regular inspection
- checklist inspection protocols
- installation protocol and sub-structure checklist

### 3.7 Training

The customer and user must take care that he has understood the functionality of this product and all safety notes and knows how to safely use this product. He must complete a training on correct use, installation, inspection, maintenance and use limitations before using this product. He should repeat the training regularly without endangering trainees or users.



**Training inspection requirements for this product must be followed (see inspection and maintenance).**

Trainings are an important part of KStrong products and services. No protective equipment will save you from injury or death if you do not know how to use it properly.

In order to ensure your safety, we offer trainings where you can learn how to safely operate this product.

For further information please contact us at [customer@kstrong.com](mailto:customer@kstrong.com)

### 3.8 Lifetime and period of use

Conditions of use and other factors may influence its useful life. You may therefore even have to repair or retire this product earlier (see below).

The shorter the descent height, the more often the rope will run through the descender device until the device has to be inspected. Short descent heights will therefore wear off the rope. Wear-off is also induced by other factors such as maintenance, sharp edges, chemical and mechanical influences etc. After max. 100 descents the rope has to be changed. Abrasion and usage have to be regularly checked. If the rope does not seem safe anymore, send the device to KStrong or a authorized person to check and replace the rope.

#### Information on work according to EN 341:2011 -1A

- work capacity: 7 500 000 Joule

#### Information on work according to EN 341:2011 - 1B (225kg - 300kg)

- work capacity: 1 500 000 Joule

The descender must never produce more than 7,500,000 joules.

Example: Descent 5 x 225kg 500m = 5 520 000 J

+ Descent 1 x 300kg 500m = 1 500 000 J

Total: 7 020 000 J

#### work $W = m \times g \times h \times n$

W = work in Joule (J)

m = load capacity (weight of the person) (kg)

g = gravity 9.81 m/s<sup>2</sup>

h = descent height in meter (m)

n = number of descents

#### Possible influencing factors

- extreme use conditions
- mechanical and chemical damage
- environmental factors
- inappropriate storage and transport

#### Recommended max. lifting distance

During lifting, descender device and rope are under more stress than during descending. Frequent use of the lifting function may lead to slip. Normally, this is not dangerous and you can descend safely to the ground. The maximum lifting distance should however not be more than 4 times the rope length. Make sure to check rope abrasion accordingly.

## 4 TRANSPORT AND STORAGE

Observe these safety notes to ensure safe storage and transport of this product.



- Always make sure that there is no liquid in the metal housing (otherwise dry the device and the rope before using it).
- Always store this product in a dry, proper place and keep it away from mechanical (e.g. sharp edges) or chemical (e.g. acids, gases) hazards, store it at room temperature and protected from light (UV radiation).
- When drying this product, always put it with the brake drums upwards to avoid humidity in the housing.
- Store and transport this product in its original (or an equivalent) packaging.
- Check the packaging regularly (holes etc.); especially, if the product is used as an emergency equipment (= sealed in special packaging).

## 5 MAINTENANCE

### 5.1 Repairs

#### Product changes

**Repairs, adjustments or changes to this product that have not been authorized by KStrong can lead to severe accidents and falls.**

- Changes (e.g. change of the rope length) and repairs have to be performed by KStrong.
- If you are not sure if this product can be used any more, do not use it but send it to KStrong or an authorized partner for inspection.

### 5.2 Cleaning

- Clean the metal parts with a wet towel.
- Never tumble-dry, never let it dry in the sun or over a heat source.
- Air-dry this product in an airy, shaded place.
- Rinse the rope with warm water and wipe it with a dry towel afterwards.
- Never disinfect the rope.
- Never use chemical detergents.

### 5.3 Disinfection

Disinfection of this product is prohibited. In case of contamination, retire this product environmentally-friendly.



## 6 INSPECTION



**DANGER**

### Inspection

**Using this product without checking it for possible damage can lead to severe accidents or death.**

- Always perform a visual and functional inspection of this product before and after each use.
- If you are not sure if this product can be used safely any more, do not use it.

Inspection by KStrong or an authorized partner is only valid under the proviso that

- this product has not been subjected to a fall,
- components of this product have not been modified,
- textile parts have not been contaminated with chemicals,
- this product has not been exposed to temperatures under  $-40^{\circ}\text{C}$  or over  $+65^{\circ}\text{C}$ ,
- metal parts have not fallen to the ground from more than 2m.



**NOTE**

### 6.1 Functional inspection

- Check if metal parts (Karabiner, housing) are damaged.
- Check if nuts and bolts are fixed.
- Check if the rope has cracks or other visual or palpable damage.
- Check if the rope runs smoothly. Pull both rope ends slowly one after the other. If you feel slight resistance, the product works.
- Check the fly wheel brakes. Pull both rope ends quickly one after the other. The rope must slide out smoothly without audible mechanical noises.

### 6.2 Regular inspections

After having been subjected to a fall, this product has to be sent to KStrong for inspection. Don't forget to give us all necessary information (where and how this product has been damaged). The results must be noted in the inspection protocol. Always keep the inspection protocol and the instructions for use with the product.

The frequency of inspections depend on use intensity and may vary according to the conditions and environment in which this product is used. If this product is subject to increased use, you may have to inspect it more than once a year.

This product has to be inspected **at least once a year**, or in any case after maximum descent distance completed, as specified in clause 2.5 (page 8). Note the operated distances in the use protocol.

**6.3 Inspection and maintenance**

Evac R+ descender, rescue and lifting device has been designed for harsh work environments. In order to ensure lifetime and period of use, all components have to be checked accordingly.

**Always perform a visual inspection before using this product. This product has to be inspected by KStrong or an authorized partner once a year. Comply with intervals and inspections regulations as indicated in the table below.**



Descender, rescue and lifting device Inspection criteria	Inspection required by user	Inspection required by competent person	Inspection required by KStrong or authorized partner	Inspection required only by KStrong
For a properly stored, not used device ...	before use, afterwards contact competent person	check packaging at least once a year according to inspection information	inspection of equipment in case of faulty packaging (humidity)	after expired lifetime period of packaging (10 years)
For training devices and devices used for standard activities (no emergency operations) ...	before and after each use		at least once a year and after maximum descent distance, see point 2.5 on page 10	if device got overloaded or dropped
For devices used in emergency operations ...			Immediately take it out of operation and carry out an inspection	Immediately take it out of operation (if device has been dropped)

If you use this product in very harsh environments (extreme weather and use conditions, heavy descents and liftings) you have to reduce the inspection period in a proper way.

## **7 RETIREMENT**

- You have to retire this product if KStrong or a competent person has stated that use is not safe.
- Retire the product in such a way that it cannot be used anymore.
- Retire this product in an environmentally friendly way. Separate materials!

## **8 RESALE**

- To ensure safe and correct use, this product may only be resold with the instructions for use and the inspection protocol.
- The instructions for use and the inspection protocol must be available in the official language of the buyer. This is within the seller's responsibility.

## 9 ACCIDENTS

The following information should help you avoid accidents. However, this information does not replace experience, responsibility and know-how and does not release you from assuming personal risk.

- Prepare a rescue plan and indicate all possible rescue measures for any given emergency situations.
- Check use and fall area before using this product and alleviate or secure them.
- In a rescue situation communication between all involved persons has to be ensured.

### 9.1 Suspension trauma



**DANGER**

#### Suspension trauma

**Falling into the rope, a long descent or being suspended for a long period can induce suspension trauma (orthostatic shock). A suspension trauma can have lifelong detrimental effects on your health and even lead to death.**

- Rescue the injured person quickly.
- Perform the correct first aid measures.

How do I know it's a suspension trauma?

- Paleness
- Sweating
- Shortness of breath
- At the onset: increased pulse rate
- Narrowing of vision
- Dizziness
- Nausea
- Later drop in pulse rate and blood pressure

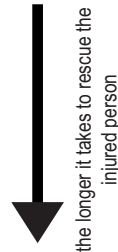

### A suspension trauma is a medical emergency!

- **Call the ambulance!**
- Free the injured person from the suspended position.
- Position the injured person with raised upper body (sitting up or squatting).
- Open straps and tight clothes.
- Monitor cardiovascular and respiratory system.
- If the casualty has no signs of life start with CPR.

If the injured person is suspended but able to move, tell him: Kick one foot with the other. Point the toes. However, this exercise will keep the blood circulation going for a short time (some minutes).

(Source: BG/GUV-I 869)



**10 LEGAL INFORMATION**

- Do not remove labels or other markings from this product.
- Use an inventory number for this product. Enter the inventory number in the inspection protocol.
- This product has a serial number. The serial number is entered on the instruction use and on the product.

**LIFESPAN:** The estimated product Lifespan is 10 years from the date of manufacture. The following factors can reduce the Lifespan of the product: intense use, contact with chemical substances, specially aggressive environments, extreme temperature exposure, UV exposure, abrasions, cuts, violent impacts, bad use or maintenance.

**DISCLAIMER:** Prior to use, the end user must read and understand the manufacturer's instructions supplied with this product at the time of shipment and seek training from their employer's trained personnel on the proper usage of the product. Manufacturer is not liable or responsible for any loss, damage or injury caused or incurred by any person on grounds of improper usage or installation of this product.

EQUIPMENT RECORD				
Product:				
Model and type/identification	Trade name	Identification number		
Manufacturer	Address	Tel, fax, email		
Year of manufacture	Purchase date	Date first put into use		
Other relevant information (e.g. Document number)				
PERIODIC EXAMINATION AND REPAIR HISTORY				
Date	Reason for entry (periodic examination or repair)	Defects noted, repair carried out and other relevant information	Name and signature of competent user	Periodic examination next due date

For EU Declaration, please visit <https://kstrong.com/asia/eu-declaration-form/>



KStrong Inc.  
150 N. Radnor Chester Road Suite F200  
Radnor, Pennsylvania 19087 United States  
Contact Email: [customer-care@kstrong.com](mailto:customer-care@kstrong.com)

[www.kstrong.com](http://www.kstrong.com)

USA	South America	Asia
-----	---------------	------

UKS/UFL201701050122-V1