



---

USER INSTRUCTION MANUAL  
**EXTENDABLE POLE HOIST &  
FLANGE BRACKET MOUNT**

THESE INSTRUCTIONS APPLY TO THE FOLLOWING MODEL:

AFT75108 & AFT730013

**EN 795:2012 Type A**

CERTIFIED PRODUCT



AUSTRALIA & NZ STANDARDS  
Certified to AS/NZS 5532:2013  
Issued by BSI  
Vide Lic. No.: BMP 760374

Please read and understand the manufacturer's instructions for each component or part of the complete system. Manufacturer's instructions must be followed for proper use, care, and maintenance of this product. These instructions must be retained and be kept available for the worker's reference at all times. Alterations or misuse of this product, or failure to follow instructions, may result in serious injury or death.

**Note:** The user is advised to keep this user instructions document for the life of the product.

**"To be used in accordance with manufacturer's instructions"**

- 1. INTRODUCTION:** The Pole Hoist is classed as a Personal Protective Equipment (PPE) by the European PPE Regulation (EU) 2016/425 and has been shown to comply with this regulation through the Harmonized European Standard EN795:2012 Type A.

The Pole Hoist is designed to minimize the risk of/provide protection against the danger of falling from heights. However, always remember that no item of PPE can provide full protection and care must always be taken while carrying out the risk related activity.

- 2. PERFORMANCE AND LIMITATIONS OF USE:**

AFT751080 has been tested as per EN 795:2012 Type A and AS/NZS 5532:2013:

EN 795:2012 test	Result/Comment
General Requirements for Anchor devices (Clause 4.2)	Securely connected eyebolts used for connection to PPE. Thus attachment points cannot become detached unintentionally (PASS). All locking pins attached by cables, thus no unlocked components evident (PASS). No sharp edges (PASS).
Static Strength (Clause 4.4.2.3)	Sustained a force of 12 kN for 3 minutes (PASS).
Dynamic Performance (Clause 4.4.2.2) & Integrity Test	When tested with rigid steel mass of 100 kg, the test mass held after test with the device remaining stable throughout.
Corrosion Resistance (Clause 4.2.1.1)	No corrosion evident after 48 hours of salt spray testing. (PASS)

AFT751080 has been tested as per AS/NZS 5532:2013 and has achieved the following performance levels:

AS/NZS 5532:2013 test	Result/Comment
Static Strength (Clause 5.3) Dynamic Performance (Clause 5.3)	Sustained a force of 15 kN for 3 minutes (PASS). When tested with rigid steel mass of 100 kg, the test mass held after test with the device remaining stable throughout. (PASS)

The KStrong Pole Hoist Davit meet or exceed ANSI Z359.1.

- 3. LIMITATIONS :**

- Extendable Pole Hoist Davit should be a personal property of its user.
- It should not be used in highly acidic or basic environments.

**4. INSTALLATION:****• Winch on Davit (AFT751080):**

**STEP 1:** Connect the base assembly with Cantilever arm followed by locking pin at base assembly.

**STEP 2:** Attached the winch AFT730020, AFT730040, AFT730120, AFT730135 on pre-installed mounting bracket of cantilever arm.

**STEP 3:** Real out the wire approx. 5 meter from winch by rotating the hoist handle.

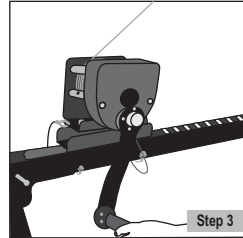
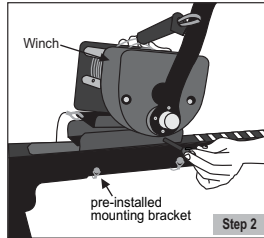
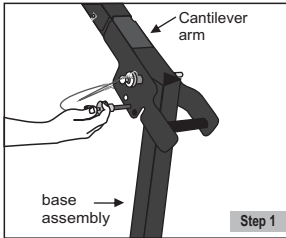

**STEP 4:** Remove locking pin of pulley from cantilever and pass the wire from guided pulley and lock the pin again. Now pass the rope from top of cantilever by rotating the hoist to match the slots and lastly pass the rope from inside of U clamp. Refer Step 4.1 to Step 4.4

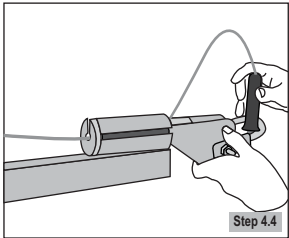
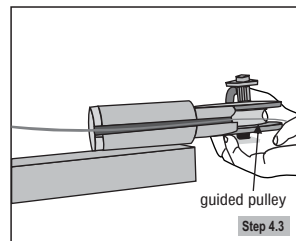
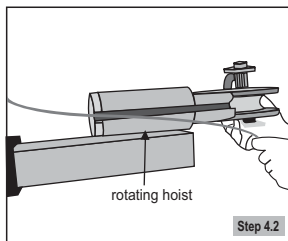
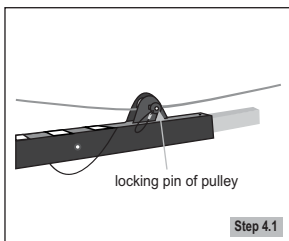

**STEP 5:** Now connect the U-clamp over the head at nearest possible anchor point with suitable connector. Refer step 5.1 & Step 5.2.

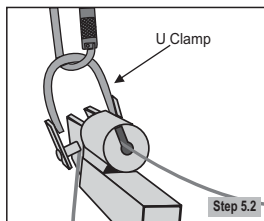
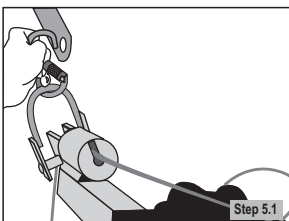

**STEP 6:** Pole hoist Davit is now ready to use.

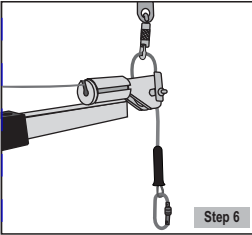

• **Retrieval Block on Davit (AFT751080):**

- STEP 1:** For installing the Retrieval block on Davit Arm, place the mounting bracket on the pre-installed universal mounting bracket.
- STEP 2:** Now place the Retrieval block between the mounting bracket and lock it using cotter pin.
- STEP 3:** Reel out the wire approx. 5 meter from retrieval & Remove locking Pin of pulley from cantilever & pass the rope of winch/retrieval guided from pulley & lock the pin again.
- STEP 4:** Remove locking pin of pulley from cantilever and pass the wire from guided pulley and lock the pin again. Now pass the rope from top of cantilever by rotating the hoist to match the slots and in last pass the rope from inside of U clamp. Refer section Installation of Winch on Davit (AFT751080) from Step 4.1 to Step 4.4.
- STEP 5:** Now connect the u-clamp over the head at nearest possible anchor point with suitable connector. Refer section Installation of winch on davit (AFT751080) from Step 5.1 & Step 5.2 to previous page.
- STEP 6:** Pole hoist Davit is now ready to use.

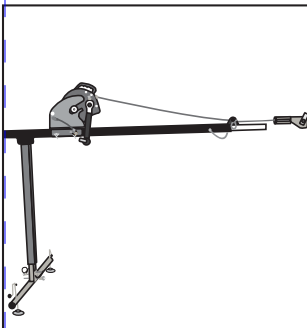
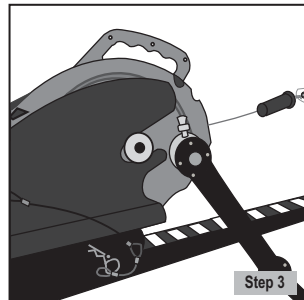
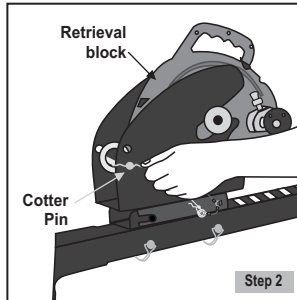
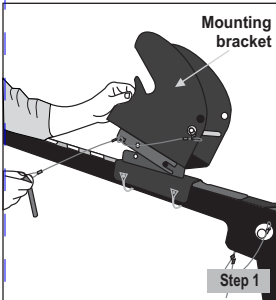

Pole hoist Davitis now ready to use.

**POLE HOIST SPECIFICATIONS-**

MINIMUM EXTENSION (2017mm)			FULL EXTENSION (2634mm)		
POSITION	HEIGHT	REACH	POSITION	HEIGHT	REACH
Lower	2438mm	1205mm	Lower	1822mm	1205mm
Middle	2250mm	2540mm	Middle	1570mm	2108mm
Upper	1715mm	2917mm	Upper	1279mm	2481mm

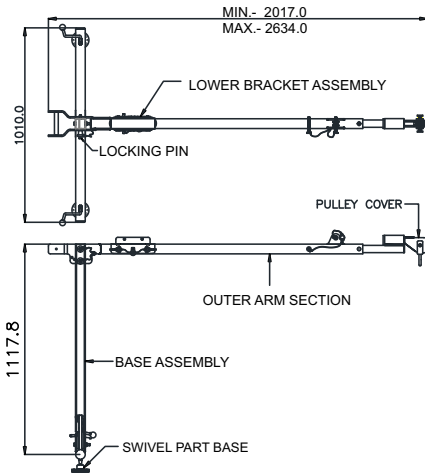

**AFT751080 (1000mm Base)**

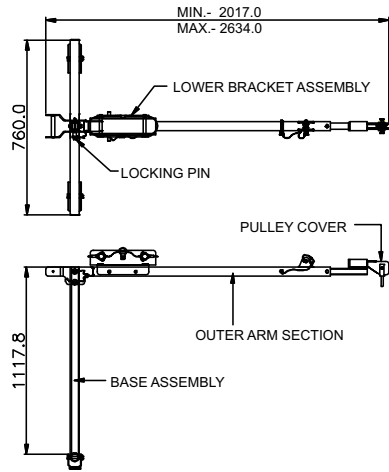

**AFT751080S (760mm base)**

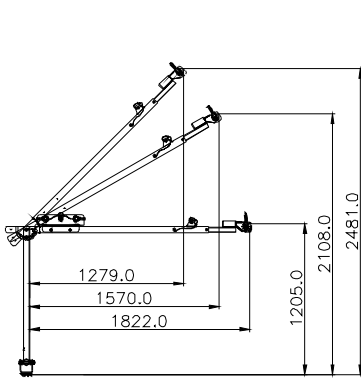

**MINIMUM EXTENSION POSITIONS**

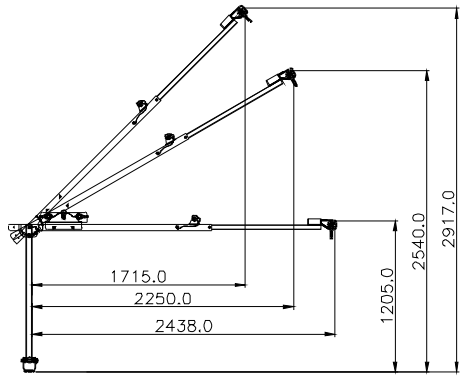

**FULL EXTENSION POSITIONS**

**AFT730013 Tank / Vessel Flange Adapter:**

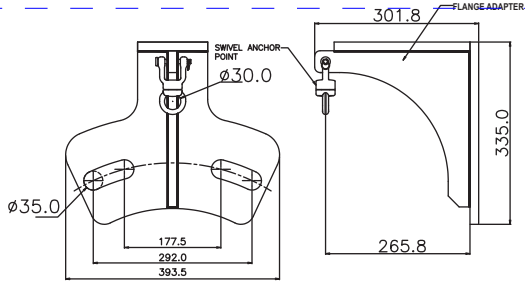

**Drawing 1**

KStrong Flange Adapter Plate has been designed as a portable anchor to be attached to various size tanks or vessels allowing the KStrong Pole Hoist to be attached directly above the tank / Vessel opening to be used for horizontal access / rescue with the pole hoist system. It can be installed on a round or square shape flanges with hole diameter of 35mm, (refer drawing 1) rated at 23kN, provide a simple and effective means for Horizontal rescues.

**Flange Adapter Plate Installation:**

Connect the Adapter plate directly onto the Flange of the tank or vessel using the existing holes, (refer drawing 2) and High Tensile Bolts to attach the plate to the Flange. Refer hole size and thickness of Tank or vessel Flange to determine bolt size.

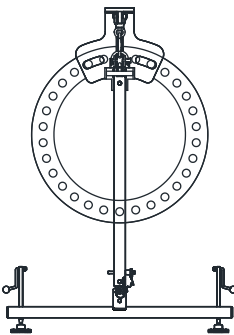

**Drawing 2**

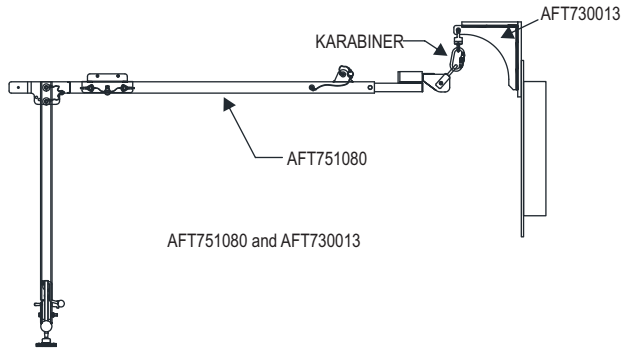

**Drawing 1**

The Adapter Plate and Bolts must be installed by qualified and experienced personnel.

Once installed you can now attach the Pole Hoist directly to the Swivel Anchor point on the Flange adapter with a rated Karabiner. (refer drawing 3).

All installations "MUST BE" approved to local standards by a qualified engineer.

**5. ADVICE & INFORMATION:**

- Ensure that the medical condition of the user does not affect his safety in normal and emergency use.
- Equipment shall only be used by a person trained and competent in its safe use.
- A rescue plan shall be in place to deal with any emergencies that could arise during the work.
- Do not make any alterations or additions to the equipment without the manufacturer's prior written consent, any repair shall only be carried out in accordance with manufacturer's procedures.
- The equipment shall not be used outside its limitation, or for any purpose other than that for which it is intended.
- It should be personal property of the user.
- Danger may arise by use of combination of items of equipment in which the safe function of any one item is affected by or interferes with safe function of another.
- Visually inspect the system before each use to ensure that it is in a serviceable condition and is operating correctly. If during inspection, doubts are raised about the safety of the system or a component, these should be replaced either by the manufacturer or a competent person.
- It is essential for the safety of the user that system should be withdrawn from service immediately if any doubt arises about its condition for its safe use. It must no longer be used until confirmed in writing by a competent person that it is safe to do so.
- Ensure that the minimum breaking strength of the chosen anchor point is greater than 12kN.
- Ensure that the harness used conforms to EN361 and dorsal and sternal attachment of full body harness are suggested for making connections.
- For equipment intended for use in fall arrest systems, we emphasize that it is essential for safety that the anchor device or anchor point should always be positioned and the work carried out in such a way as to minimize both the potential for falls and potential fall distance. Where it is essential that the anchor device/point is placed above the position of the user, the manufacturer shall make a statement to that effect
- A full body harness is the only acceptable body holding device that can be used in a fall arrest system.
- For equipment intended for use in fall arrest systems, we emphasize that it is essential for safety to verify the free space required beneath the user at the workplace before each occasion of use, so that in case of a fall there will be no collision with the ground or other obstacle in the fall path.
- Always use standard packaging of the manufacturer to prevent any damage to the product during transportation and storage.
- Ensure that Equipment is properly installed on the surface parallel to horizontal by height adjuster mechanism.
- When equipment becomes wet either during use or by cleaning, it must be allowed to dry naturally and shall be kept away from direct heat.
- No lubrication required.
- Unit is for single user only.
- Anchor Device may be used only for personal fall arrest and not for lifting purpose.
- Anchor device should be installed by only by a competent person.
- It is essential for the safety of the user that if the product is resold outside the original country of destination, the reseller shall provide instruction for use, for maintenance, for periodic examination and for repair in the language of the country in which product is to be used.
- Never use the Davit Arm device in a vertical configuration of the arm other than the all back position - danger of overturning of the device.

**Following conditions may be hazardous & may affect the performance of Retractable Fall Arrester:-**

- Extreme temperatures
- Trailing or looping of Lanyards over sharp edges.
- Extreme acidic or basic environments.
- Abrasive or sharp edge structures which can damage the equipment.

Following Pre-use checkpoints must be addressed :-

- Detent Pins are properly installed and are in working condition.
- Check the condition of winch wire and ensure it is in good condition.
- Eye bolts/Anchor points are intact.
- Telescopic sections are working properly.
- Mounting brackets are properly installed.

6. **COMPATIBILITY:** To optimize protection, in some instances it may be necessary to use the equipment with suitable PPE such as boots/gloves/helmet/ear defenders. In this case, before carrying out the risk-related activity, consult your supplier to ensure that all your protective products are compatible and suitable for your application.
7. **INSPECTION:** Visually inspect the system before each use to ensure that it is in a serviceable condition and is operating correctly. If during inspection, doubts are raised about the safety of the system or a component, these should be replaced either by the manufacturer or a competent person.
8. **STORAGE AND TRANSPORT:** When not in use, store the tripod in a well-ventilated area away from heavily acidic or basic environment. Never place heavy items on top of it. Also ensure that the tripod is stored away from chemically hazardous environment preferably storage should be in a dry environment.
9. **REPAIR:** If the product becomes damaged, it will NOT provide the optimum level of protection, and therefore should be immediately removed from service. Never use the damaged product. Repair is permitted, provided that it is either done by the manufacturer or a competent repair centre or individual approved by the manufacturer.
10. **CLEANING:** In case of minor soiling, wipe the tripod with cotton cloth or a soft brush. Do not use any abrasive material. For intensive cleaning wash the tripod in water at a temperature between 30°C to 60°C by using a neutral detergent (pH 07). The washing temperature should not exceed 60°C. Do not use acid or basic detergents.
11. **WITHDRAWAL FROM USE :** If the system has been used to arrest a fall, it should be removed from service and returned to the manufacturer or a competent repair centre for servicing and retesting.
12. **PERIODIC EXAMINATION:**
  - It is important to conduct regular periodic examination of the product because the safety of the user depends upon the continued efficiency & durability of the product.
  - The frequency of examination should be at least once in a year however it can be more than once if legislation requires, or frequency of use is high or environmental conditions have an adverse effect on it eg excessive rain, sea side environment, excessive heat etc.
  - It is emphasized that the examination be conducted only by a competent person and strictly in accordance with the manufacturer's periodic examination procedures.
  - It is also advised the competent person be duly trained and authorized by the manufacturer.
  - Ensure that all markings on the product are legible and can be clearly read.
  - It is the responsibility of the user to keep the below record card update by entering the details mentioned in it.



**Label**

(i) **KSTRONG®**  
UNRIVALED SAFETY.  
**EXTENDABLE POLE  
HOIST**

(ii) **AFT751080**

(iii) **Load Capacity: 140 Kg**  
**UID: XXXXXXXXXXXXXXX**

(iv) **Date of mfg.: XXXX**

(v) **MBS: 15kN**

(vi) **Adjustable Height:**  
1.32m to 3.14m

Date of First Use:

**INSPECTION LOG**

YR	M	J	F	M	A	M	J	J	A	S	O	N	D
20													
20													
20													
20													
20													
20													
20													
20													
20													
20													

*Read User's Manual  
Carefully Before Use*

**CERTIFIED PRODUCT**

**QR CODE**

AUSTRALIA & NZ STANDARDS  
Certified to AS/NZS 5532:2013  
Issued by BSI  
Vide Lic. No.: BMP 760374

(vii) **EN 795:2012 Type A  
AS/NZS 5532:2013**

KStrong Asia Pte Ltd  
33A Chander Road, Singapore 219539

**MADE IN INDIA**

- The Davit arm is marked with :**
- (i) Identification of the manufacturer
  - (ii) Type or product code
  - (iii) UID for traceability
  - (iv) Manufacturing date
  - (v) Minimum Breaking Strength
  - (vi) Adjustable Height
  - (vii) Norms Reference

**KSTRONG®**  
UNRIVALED SAFETY.

**FLANGE  
ADAPTER  
PLATE WITH  
SWIVEL EYE**

**AFT730013**

UID : XXXXXXXXXXXXXXX  
Date of Mfg : XXXX  
M.B.S. : 23kN  
EN 795:2012 Type A

KStrong Asia Pte Ltd  
33A Chander Road, Singapore 219539

**MADE IN INDIA**

**LIFESPAN:** The estimated product Lifespan is 10 years from the date of manufacture. The following factors can reduce the Lifespan of the product: intense use, contact with chemical substances, especially aggressive environments, extreme temperature exposure, UV exposure, abrasions, cuts, violent impacts, bad use or maintenance.

**DISCLAIMER:** Prior to use, the end user must read and understand the manufacturer's instructions supplied with this product at the time of shipment and seek training from their employer's trained personnel on the proper usage of the product. Manufacturer is not liable or responsible for any loss, damage or injury caused or incurred by any person on grounds of improper usage or installation of this product.

<b>EQUIPMENT RECORD</b>				
Product				
Model & type/Identification		Trade Name		Identification number
Manufacturer		Address		Tel, email into use
Year of manufacture		Purchase Date		Date first put into use
Other relevant information (eg. document number)				
<b>PERIODIC EXAMINATION AND REPAIR HISTORY</b>				
Date	Reason for entry (periodic examination or repair)	Defects noted, repairs carried out and other relevant information	Name and signature of competent person	Periodic examination next due date



**Certification Body & Ongoing Assessment Body:**

BSI Group ANZ Pty Limited, A.B.N. 72 078 659 211, Suite 2, Level 7, 15 Talavera Road, Macquarie Park NSW 2113 Australia.

**Certification Body:**

SATRA Technology Centre, Wyndham Way, Telford Way, Kettering, NN16 8SD, UK (Notified Body 0321)

For EU Declaration, please visit <https://kstrong.com/asia/eu-declaration-form/>



KStrong Asia Pte Ltd  
33A Chander Road, Singapore 219539

Contact Email: [customercare@kstrong.com](mailto:customercare@kstrong.com)

[www.kstrong.com](http://www.kstrong.com)

---

USA

South America

ASIA

---