



AFF8000 & AFF9000  
**FXLINE VERTICAL**  
LIFELINE ALUMINUM  
RAIL

USER INSTRUCTION MANUAL  
&  
TECHNICAL INFORMATION



MUST BE READ AND UNDERSTOOD PRIOR TO INSTALLATION



### **Disclaimer**

The information provided in this User Instruction is based on the technical data that KStrong obtained under laboratory conditions and believes to be reliable. KStrong does not guarantee results and takes no liability or obligation in connection with this information. Since conditions of end-use are beyond our control, it is the user's responsibility to determine the hazard levels and the use of proper personal protective equipment. Persons having technical expertise should undertake evaluation under their specific end-use conditions, at their discretion and risk. Please ensure that this information is only to check that the product selected is suitable for the intended use. Any product that is damaged, torn, worn, or punctured should be discontinued from usage immediately.

# CONTENTS

Know Your System	01
Standards	02
Instruction Guide	03
Receiving Structure	05
<b>FALL ARREST SYSTEM</b>	06
AFF8000 Fall Arrest System	06
AFF9000 Fall Arrest System	07
<b>COMPONENT CHART</b>	08
Component Chart AFF8000	08
Component Chart AFF9000	09
Aluminum Rail Extension	11
Aluminum Rail Intermeditate AFF531100	12
Vertical Trolley : AFF539000	13
Karabiner AFC6011101	13
Rung Clamp : AFF533500	14
Extendable Mounting Bracket : AFF533800 & AFF533801	14
Ceiling Mounting Bracket :AFF533700	15
Junction Clamps : AFF533000	15
Rail Extremity AFF531710	16
Ladder Rung Assembly AFF532000	16
3m Folding Aluminum Rail AFF532210	17
<b>INSTALLATION</b>	18
General	18
Pre-Installation Inspection of the Receiving Structure	18-22
<b>PRE- USE CHECKS &amp; PRECAUTIONS</b>	23
Post Installation Inspection	23
Precautions While Using the System	24
<b>INSPECTION USE AND MAINTENANCE</b>	25
PPE Inspection and Revalidation	25
Warranty	26
Tools Required	27-28
Notes	29-30
Inspection Log	31

## Know Your System

### AFF8000 & AFF9000 Vertical Rail Life Line Systems

The Vertical Rail Life Line Systems (Certified to EN 353-1:2014 +A1:2017 & AS/NZS 5532:2013) are integrated fall arrest solution made of Aluminum Rail and Guided-Type Fall Arrest Trolley. The line is constructed by joining the aluminum rail Intermediates using junctions clamps to connect them to each other. Rung Clamps secure to the system to the ladder rungs. The trolley moves up and down on the line securing the user by connecting with a karabiner. In the event of a fall, the trolley immediately locks on the rail, thus arresting the fall. Also, while not in use, the unidirectional locking system of the trolley prevents it from sliding down on its own.

The rail can be fitted with an extension arm that provides a basic and effective tool to provide additional support for assisting users while transitioning from a ladder to a raised working surface or work platform, ensuring the user is always connected with the trolley.

The bottom most section of the aluminum rail extremity is equipped at the end with a lock that prevents the trolley from detaching the rail.

This system can be used on tele-communications towers, radio and TV masts, power supply and hydroelectric installations, wind power facilities, construction, chimney and industrial plants, buildings and facades, crane installations, shafts and manholes, aircraft hangars and for loading / unloading of trains and vehicles, petrochemical plants, on-shore and off-shore oil rigs, shipbuilding. It is certified to EN353-1:2014+A1:2017. The system is also ATEX certified to comply with use in potentially explosive atmosphere (as per Potentially Explosive Atmospheres Directive 94/9/EC) and conforms to Norms EN 13463-1: 2009 and EN 13463-5: 2003.







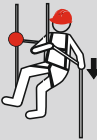

**AFF8000**

**AFF9000**

# VERTICAL ANCHORAGE RAIL LIFE LINE SYSTEM

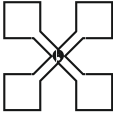
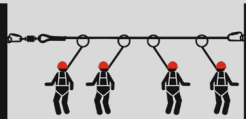
## Standards

Standards		Description
EN 353-1		Guided type fall arresters including a rigid anchor line
EN 353-2		Guided type fall arresters including a flexible anchor line
EN 795 Type A		Anchor device requiring the fixing of one or more structural anchors
EN 795 Type B		Anchor device not requiring the fixing of one or more structural anchors
EN 795 Type C		Anchor devices using a horizontal flexible anchor line
EN 795 Type D		Anchor devices using a horizontal rigid anchor line
EN 795 Type E		Deadweight anchoring device
CEN/TS 16415:2013		Personal fall protection equipment - Anchor devices - recommendations for anchor devices for use by more than one person simultaneously
 II 2G Ex h IIc T6 Gb EN 80079-36:2016 EN 80079-37:2016		The ATEX directives are two EU directives describing the minimum safety requirements for workplaces and equipment used in explosive atmospheres

## Must be Read Prior to Use

---

- Prior to use, ensure all operating procedures have been read and properly understood.
- This fall arrest system is only to be used by competent persons who have experience and training in the safe use of the system and associated equipment.
- Ensure all local workplace OH&S requirements are identified and understood.
- A risk assessment with a safe work method procedure must be completed and approved by management prior to work commencing.
- The systems requires periodic inspection and maintenance by the manufacturer or their authorized representative as per EN365 of the PPE Regulation 2016.
- The system **MUST NOT** be used if the service date is overdue.
- A rescue plan must be formulated and ready for implementation prior to using any fall arrest system.
- Authorisation to access any risk area must be obtained from the person in control of the workplace.
- Only approved full body harness, lanyard and PPE certified either EN, ANSI or AS/NZS Standards are to be used with this system.
- Visually inspect the system for damage prior to use. The system must not be used if there is any deterioration or deformation of components or the structure to which the system is attached.
- If the safety system is damaged or has arrested a fall, discontinue use until it has been fully inspected and recertified by the manufacturer or their authorized representative.
- Ensure all fixings, fittings and components are securely attached. Any tightening, adjustment or replacement of components must be carried out by a competent person.
- Users must not be allowed to work alone in fall arrest situations in case emergency rescue assistance or first aid is required.
- All applicable EN Standards, Local OHS Acts & Regulations, and Codes of Practice & Guidelines must be read and obeyed when using this safety system.

## Instructions for Periodic Examinations

---

- As per EN 365 of PPE Regulation 2016, it is necessary to carry out regular periodic examinations. The safety of the users depends upon the continued efficiency and durability of the equipment.
- The personal protective equipment shall be examined at least every 12 months.
- For corrosive/harsh environments, every 6 months (more frequent inspection may be required).
- The periodic examination can only be carried out by the manufacturer or their authorized representative.
- The comments should be included in the check card of the equipment. After the periodic examination, the next due date for periodic examination will be determined.
- During periodic inspection, it is necessary to check the legibility of the equipment marking.
- To check metals for sharp edge, burs, corrosion, bent profile distortion and opening & closing or such mechanisms for which that is intended for.

## Remove from Service

---

- In case that it has been used to arrest a fall, the equipment must be withdrawn from use.
- Labels have been removed, are missing or illegible
- Excessive abrasive wear has occurred
- Broken fibres, tears, cuts, snags and splinters are present
- Deterioration or stretching has occurred
- Parts and mechanisms are not moving freely or are corroded
- There is excessive contamination not removed by approved cleaning methods

# VERTICAL ANCHORAGE RAIL LIFE LINE SYSTEM

## Job Safety Analysis

Before commencing the job, it is recommended that the service technician / installer completes a JSA form, to identify hazards at site and to decide the correct PPE they need to mitigate the hazard. Refer to the example below.

Section 1 Job details					
JSA title	Project name		Work order or PID No.		
	Principal contractor				
Location / address				Date/s of activity	
Prepared by		Date prepared		Signature	

Permits required				Isolations required	
<input type="checkbox"/> Confined Space	<input type="checkbox"/> High risk work rescue plan	<input type="checkbox"/> High voltage access	<input type="checkbox"/> Roof Access	<input type="checkbox"/> Mechanical	<input type="checkbox"/> Hydraulic
<input type="checkbox"/> Work at height	<input type="checkbox"/> Excavation and trenching	<input type="checkbox"/> Energized work	<input type="checkbox"/> Other (please specify)	<input type="checkbox"/> Electrical	<input type="checkbox"/> Pneumatic
<input type="checkbox"/> Penetrating	<input type="checkbox"/> Grid mesh, flooring and guard rail removal	<input type="checkbox"/> Hot work		<b>Site access required</b>	<input type="checkbox"/> YES <input type="checkbox"/> NO

### Section 2-Common hazards (Each Hazard identified below must be assessed)

Chemicals/hazardous substances		High-risk activities	
Name of chemicals or hazardous substance <input type="checkbox"/> SDS available		<input type="checkbox"/> Confined space	<input type="checkbox"/> Work at heights
		<input type="checkbox"/> Hot Work	<input type="checkbox"/> Excavation, trenching or penetrations
Energy sources		<input type="checkbox"/> Construction work	<input type="checkbox"/> Scaffolding
<input type="checkbox"/> Electricity	<input type="checkbox"/> Pressure	<input type="checkbox"/> Demolition	<input type="checkbox"/> Structural alterations
<input type="checkbox"/> Gas / Fuel	<input type="checkbox"/> Water	Work location	
Plant and equipment		<input type="checkbox"/> Sun	<input type="checkbox"/> Working over, in or near water
<input type="checkbox"/> Fixed Plant	<input type="checkbox"/> Mobile Plant	<input type="checkbox"/> Plants, Animals or Insects	<input type="checkbox"/> Contaminated / Flammable atmosphere
<input type="checkbox"/> Vehicles / boats	<input type="checkbox"/> Hand Tools	<input type="checkbox"/> Slips, trips and falls	<input type="checkbox"/> Work occurring in other areas
Manual tasks		<input type="checkbox"/> Biological hazards	<input type="checkbox"/> Fire
<input type="checkbox"/> Repetitive tasks	<input type="checkbox"/> Heavy Lifting	People	
<input type="checkbox"/> Awkward posture	<input type="checkbox"/> Sustained posture	<input type="checkbox"/> Remote or isolated work	<input type="checkbox"/> Contractors
Facilities / built environment		<input type="checkbox"/> Fatigue	<input type="checkbox"/> Visitors / land owners / public
<input type="checkbox"/> Buildings and fixtures	<input type="checkbox"/> On/in or adjacent to roadways	<input type="checkbox"/> Competency or training required	<input type="checkbox"/> License required
<input type="checkbox"/> Open pits, trenches or tunnels	<input type="checkbox"/> Asbestos/ lead	Environment and water quality	
<input type="checkbox"/> Overhead objects or services	<input type="checkbox"/> Underground objects or services	<input type="checkbox"/> Erosion & sediment control	<input type="checkbox"/> Waste/ discharge
<input type="checkbox"/> Lighting	<input type="checkbox"/> Noise	<input type="checkbox"/> Emissions (or air pollution)	<input type="checkbox"/> Flora/ fauna/ weed management
<input type="checkbox"/> On or near pressurized gas distribution mains or piping	<input type="checkbox"/> On or near chemical. fuel or refrigerant lines	<input type="checkbox"/> Release to drains/waterways	<input type="checkbox"/> Water quality





# VERTICAL ANCHORAGE RAIL LIFE LINE SYSTEM

## AFF8000 Fall Arrest System



Aluminum Extension  
AFF531500

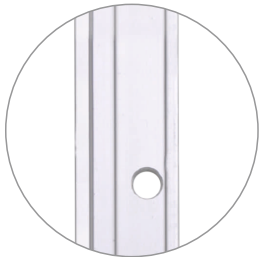

Aluminum Rail  
Intermediate  
AFF531100



Aluminum Rail  
Extremity  
AFF531710

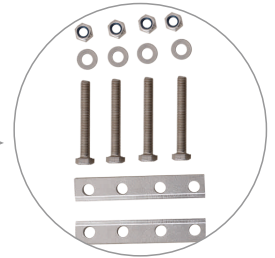
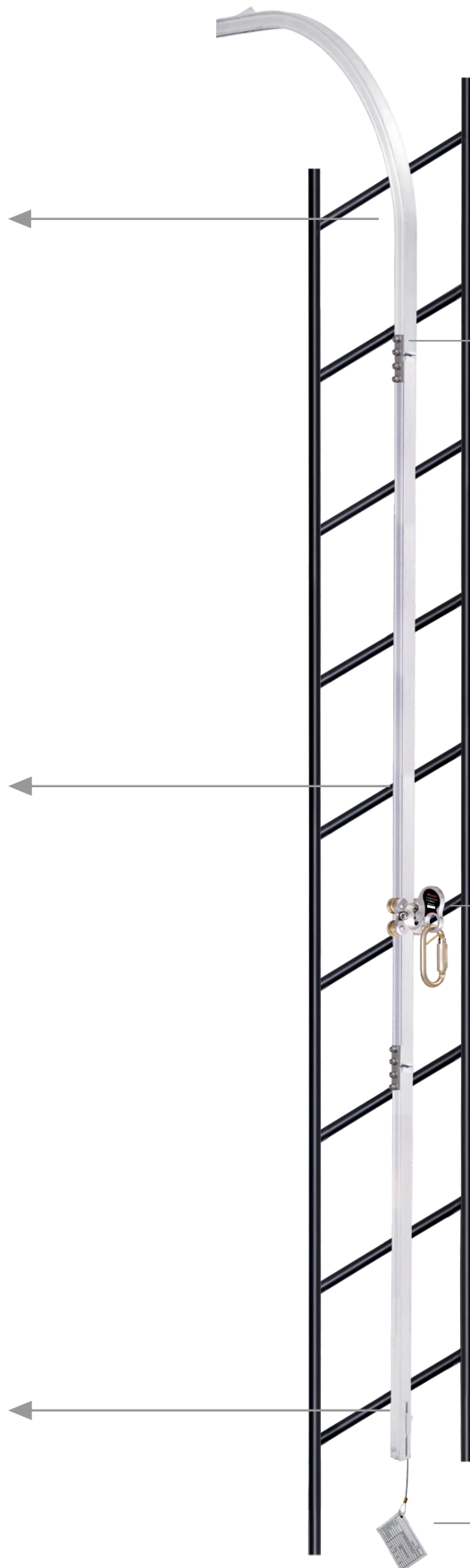

Junction Clamps  
AFF533000



Vertical Trolley  
AFF539000



Inspection Plate  
AFF115100V

# VERTICAL ANCHORAGE RAIL LIFE LINE SYSTEM

## AFF9000 Fall Arrest System



Aluminum Extension  
AFF531500

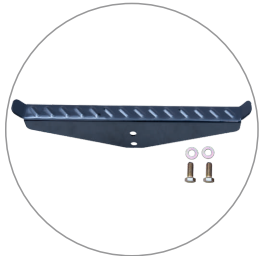

Ladder Rung  
Assembly  
AFF532000

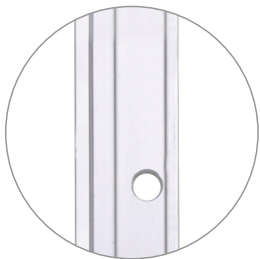

Aluminum Rail  
Intermediate  
AFF531100



Aluminum Rail  
Extremity  
AFF531710

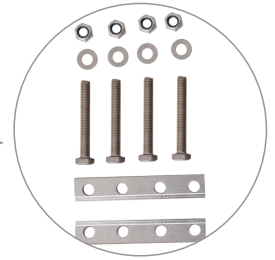

Junction Clamps  
AFF533000



Vertical Trolley  
AFF539000



Inspection Plate  
AFF115100V

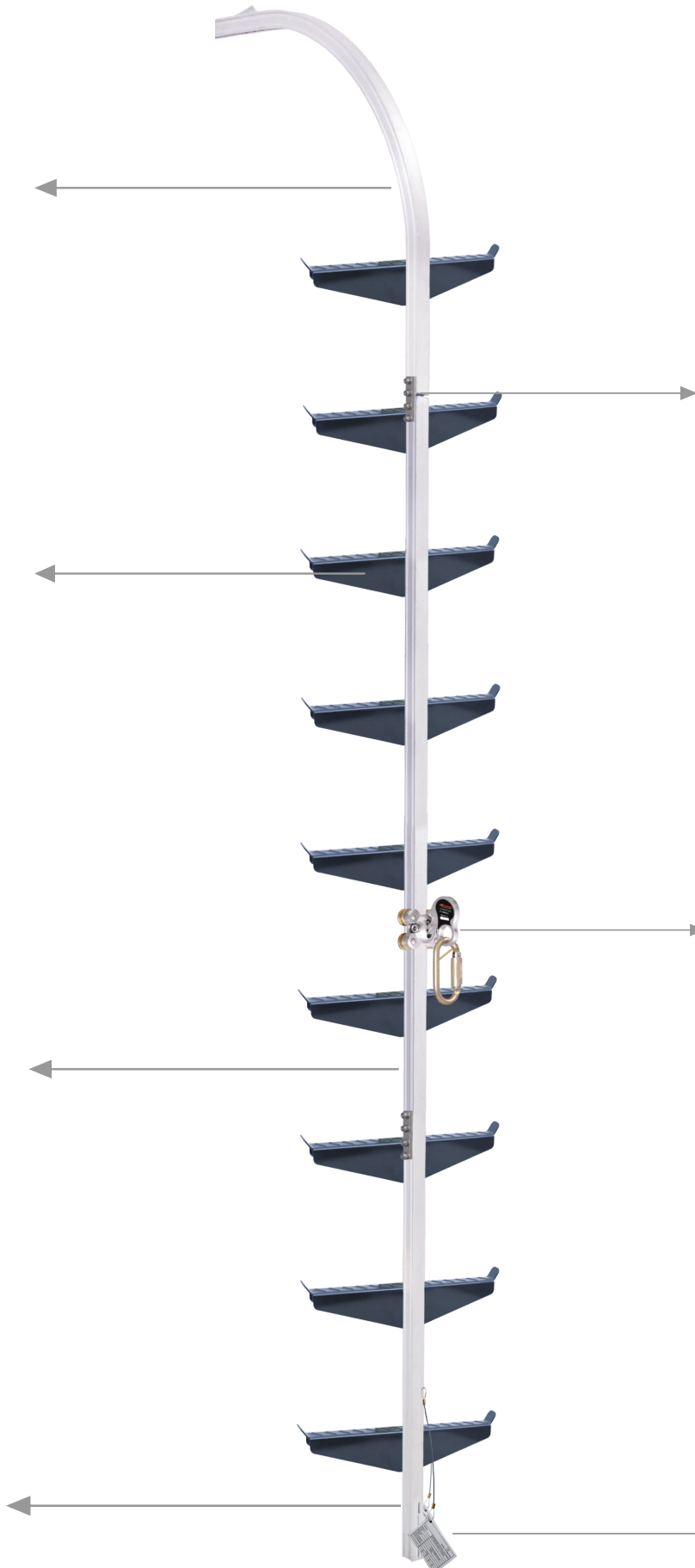

# VERTICAL ANCHORAGE RAIL LIFE LINE SYSTEM

## Component Chart AFF8000

The chart below shows all the components and certification of the AFF8000 Rail System with their appropriate reference nos. and quantity required in a system.

### TECHNICAL SNAPSHOT

Component	Code	Qty. Required
Aluminum Extension Arm	AFF531500	1 no.
Aluminum Rail Intermediate	AFF531100	As per the length required (in multiples of 3 meters)
Vertical Trolley	AFF539000	1 per user
Karabiner	AFC601100	1 per vertical trolley
Rung Clamp	AFF533500	1 per meter
Junction Clamp	AFF533000	One less than total no. of rail sections length of rail Intermediate
Alu. Rail Extremity	AFF531710	1 no.
Inspection Plate	AFF115100V	1 no.
Certified to	EN353-1:2014+A1:2017, AS/NZS 5532:2013 & ATEX directive 2014/34/UE	

# VERTICAL ANCHORAGE RAIL LIFE LINE SYSTEM

## Component Chart AFF9000

The chart below shows all the components and certification of the AFF9000 Aluminum Rail System with their appropriate reference nos. and quantity required in a system.

### TECHNICAL SNAPSHOT

Component	Code	Qty. Required
Aluminum Extension Arm	AFF531500	1 no.
Aluminum Rail Intermediate	AFF531100	As per the length required (in multiples of 3 meters)
Vertical Trolley	AFF539000	1 per user
Karabiner	AFC601100	1 per vertical trolley
Ceiling Mounting Bracket	AFF533700	1 per meter
Mounting Post	AFF533801	1 no.
Junction Clamp	AFF533000	One less than total number of alurail sections
Alu. Rail Extremity	AFF531710	1 no.
Ladder Rung Assembly	AFF532000	11 nos. per rail
Ladder Rung Assembly Right	AFF532200	11 nos. per rail
Ladder Rung Assembly Left	AFF532100	11 nos. per rail
Collapsible Ladder Assembly		11 nos. per rail
Inspection Plate	AFF115100V	1 no.
Certified to	EN353-1:2014+A1:2017, AS/NZS 5532:20136 & ATEX directive 2014/34/UE	

## Recommended PPE

While working on a roof, the user can select from a range of PPE to work safely with either lanyards, rope lines or SRL's in conjunction with a full body harness.



Energy Absorbing  
Webbing Lanyard  
AFL408612



Work Positioning  
Lanyard with Grip  
Adjuster  
AFL405111



Rope Line with  
Shock Absorber  
AFA951201



Twin Micron  
AFS550028D



Full Body Roofers Harness  
AFH300203

# VERTICAL ANCHORAGE RAIL LIFE LINE SYSTEM



AFF8000



Aluminium Rail Intermediate  
AFF531100



Junction Clamp  
AFF533000



Ceiling Mounting Bracket  
AFF533700



Extendable Bracket  
AFF533801



Aluminium Rail Extremity  
AFF531710

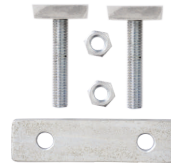

Rung Clamp  
AFF533500



Mounting Nut  
AFF533790



Ladder Rung  
AFF532000



AFF9000



Aluminium Extension  
AFF531500



Karabiner  
AFC601101



Vertical Trolley  
AFF539000

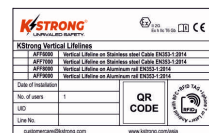

Inspection Plate  
AFF115100V

## Alu Rail Extension

The Aluminum Rail Extension arm provides supports to the user at the landing platform. The user can now disengage the trolley while safely standing on the landing platform.



### TECHNICAL SNAPSHOT

	AFF531500	AFF531600	AFF531650
Application	Aluminum extension arm at the ladder end over the working platform.	Post to support extension arm suit trapezoidal roof	Post to support extension arm suit standing seam roof
Material	6063 T6 Aluminum	High Tensile Steel ED Coated Black	High Tensile Steel ED Coated Black with 6005 T5 Aluminum Clamps
Weight	2.07 kgs	9.329 kgs	9.076 kgs
Conforms to	EN353-1:2014 + A1:2017 ATEX Directive 2014/34/UE	EN353-1:2014 + A1:2017	EN353-1:2014 + A1:2017

## Aluminum Rail Intermediate AFF531100

The Aluminum Rail Intermediate is the aluminum rail on which the trolley slides smoothly without friction aluminum rail intermediates comes in standard length of 3 meters and are connected from one intermediate to another by functions.



### TECHNICAL SNAPSHOT

AFF531100

Application

The design of the aluminum section provides easy and friction free movement of the trolley.

Length

3m

Material

Aluminium Alloy

Weight

4.0 kg for a length of 3 meters

Vital Test Compliance

Static Strength : 15 kN for 3 min

# VERTICAL ANCHORAGE RAIL LIFE LINE SYSTEM

## Vertical Trolley : AFF539000

The Vertical Trolley travels up and down on the aluminum rail along with the user. In the event of a fall, the trolley arrests the fall. In combination with a harness with ventral attachment, the trolley assists the user while climbing.

### TECHNICAL SNAPSHOT

AFF539000

**Application** The design of the aluminum section provides easy and friction free movement of the trolley.

**Material** Stainless Steel 316 and Brass

**Weight** 600 gms

**Vital Test Compliance** Static Strength : 15 kN for 3 min

**Conforms to** EN 795:2012 Type C and  
TS16415, AS/NZS 5532:2013



## Karabiner AFC6011101

The Karabiner connects the vertical trolley to the user's harness.

### TECHNICAL SNAPSHOT

AFC6011101

**Application** Quarter turn locking steel karabiner is used to connect the trolley to the harness of the user.

**Material** High Strength Alloy Steel

**Weight** 170 gm

**Vital Test Compliance** Static Strength : 23 kN for 3 min

**Conforms to** EN 362:2004 Class B





# VERTICAL ANCHORAGE RAIL LIFE LINE SYSTEM

## Rung Clamp : AFF533500

The Aluminum Rail can be mounted directly on to ladder rungs by the rung clamp. The rung clamps may be mounted at every 1.5 meters.

### TECHNICAL SNAPSHOT

AFF533500	
Application	Rung clamps help to hold the aluminum rail against the ladder rung.
Material	Stainless Steel 316
Weight	0.7 kg
Finish	Electro Polished

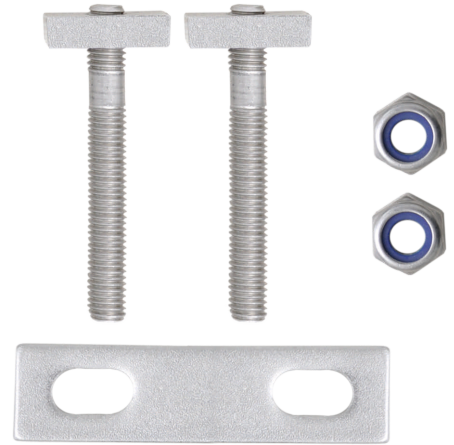

## Extendable Mounting Bracket : AFF533800 & AFF533801

To install the aluminum rail system on a pre-engineered building, the adjustable bracket is the right choice. The brackets are adjustable to account for different sizes of purlins. The brackets are either welded or fixed by nuts and bolts on the column.



### TECHNICAL SNAPSHOT

	AFF533800	AFF533801
Application	To mount the aluminum rail system on the column of the pre-engineered building	To mount the aluminum rail system on the column of the pre-engineered building
Material	Stainless Steel 316: Polished	High Tensile Steel ED Coated Black
Weight	5.366 kgs	4.80 kgs.

## Ceiling Mounting Bracket :AFF533700

The flush type bracket is best suited for mounting the aluminum rail on the wall. The recess that is created is helpful to provide a good foot hold on the ladder rungs.

### TECHNICAL SNAPSHOT

AFF533700

Application The aluminum rail system is fitted on the floor and ceiling with ceiling mounting brackets.

Material Stainless Steel 316

Weight 0.676 kg



## Junction Clamps : AFF533000

The Aluminum Rail comes in standard lengths of 3 meters. When the span is more than 3 meters, multiple lengths may be joined easily by the junction clamps.

### TECHNICAL SNAPSHOT

AFF533000

Application Junctions are provided to connect different sections of the aluminum rail system

Bolts and Nut Assembly Stainless Steel 316

Junction Aluminum Alloy

Weight 0.18 kg



## Rail Extremity AFF531710

The Aluminum Rail Extremity has a spring loaded trolley halt jib termination which ensures that the trolley does not accidentally move off the rail. It is also provided with an L-clamp to ensure that the trolley is not inserted in the wrong way.

### TECHNICAL SNAPSHOT

AFF531710

**Application** The aluminum rail extremity has a trolley halt jib at one end to prevent the trolley from detaching the aluminum rail accidentally.

**Material** Aluminum Alloy, Finish: Shot Blasted & Zinc Plated

**Weight** 4.1 kgs for a 3m Length



## Ladder Rung Assembly AFF532000

The ladder rung assembly provides a robust step on the aluminum rail. The special grooved design provides friction for better user stability while climbing.



### TECHNICAL SNAPSHOT

AFF532000

AFF532100 and AFF532200

**Application** The special grooved design ladder rung provide surface that allows a slip free grip while climbing

Left & Right ladder rungs provide offset installation to accommodate the users stride lengths

**Material** High Tensile Steel ED Coated

High Tensile Steel ED Coated Black

**Weight** 750 gms

490 gms

## 3m Folding Aluminum Rail AFF532210

The rungs of the Folding Aluminum Rail can be folded and locked to avoid unauthorized climbing on the ladder.

### TECHNICAL SNAPSHOT

#### 3m Folding Aluminum Rail

Application Locking arrangement in the ladder to prevent unauthorized access.

Material Aluminum rail and hot dipped galvanized alloy steel

Weight 11 kgs

Finish Anodized

Conforms to EN 795:2012 Type C and TS16415, AS/NZS 5532:2013

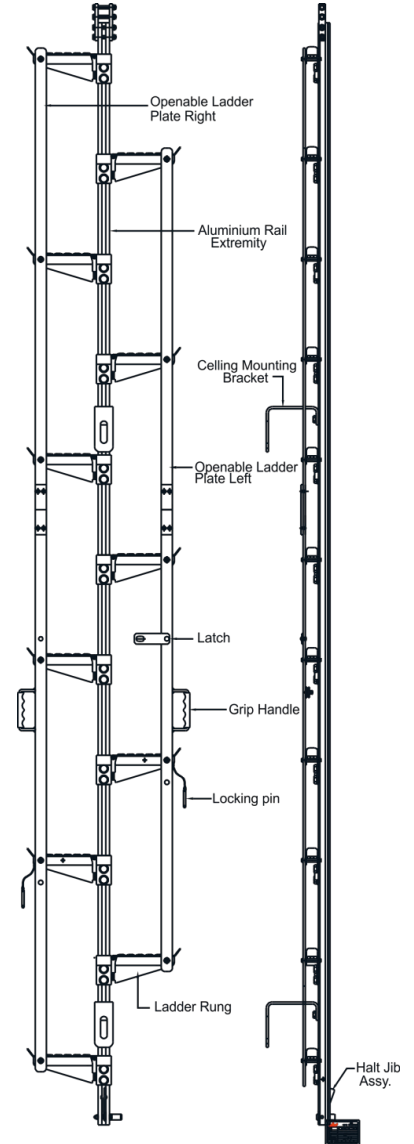

## Installation

### General

⚠ The installation of the system shall be carried out only by trained authorized personnel of KStrong, and should not be carried out by the user. The Installation steps given below are a brief indication of the procedure of the same, only for the purpose of information to the user. KStrong does not take any responsibility for consequences of system installation if it is carried out against an authorized written recommendation by KStrong .

It is necessary to ensure the safety of the installer at all stages of Installation through use of correct PPE. It is also important to use correct tools as recommended by KStrong for installation.

### Pre-Installation Inspection of the Receiving Structure

The receiving structure on which the system is to be installed should be strong enough to hold an impact load be 15 kN. KStrong shall not be held responsible in any failure arising out of the failure of the structure.

It is hence essential to calculate the strength of the receiving structure before the installation. If in doubt, a competent person or a qualified structural engineer may study the drawings or visit the site and verify the strength adequacy of the receiving structure.

### Installation of the System on the Receiving Structure

#### Step 1: Installation of Aluminum Rail Extremity

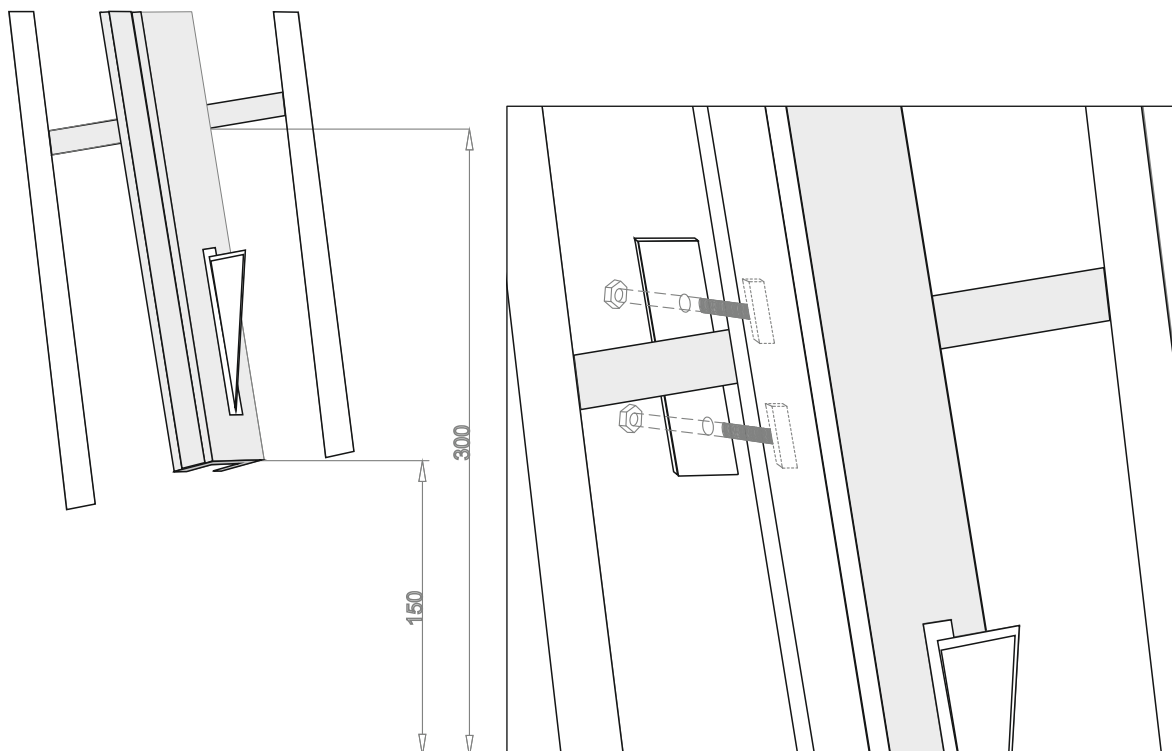

## Step 2: Junction

Join two lengths of aluminum rail intermediate. Match the sections of both the aluminum rail. Slide the rail aligner (ALD-ALU-U-F) over the joint so that the joint is in center of the aligner. This will ensure perfect alignment of two rails. Place the junction plate on either side of the aluminum rail with the holes of the junction plate matching with those of aluminum rail intermediate. Fix both the plates with 4 sets of fasteners.

Ensure that the gap between the two rails is not greater than 1.5 mm. Remove the rail aligner (ALD-ALU-U-F) from the rail and use it for the next joint.

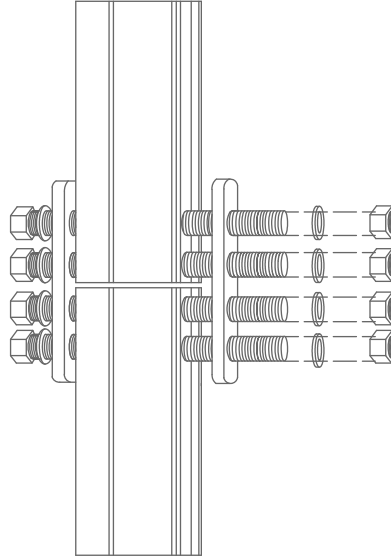

## Step 3: Installation of Aluminum Rail Extension

- Repeat step 2 to join the aluminum rail extension with the aluminum rail intermediate.
- Select the correct aluminum rail extension support depending upon the type of roof.
- Connect the aluminum rail extension support to the end of the aluminum rail extension using a mounting nut.
- For trapezoidal roof sheets, use blind rivets to install the aluminum rail extension support to the roof, for standing seam fasten the bracket using nut bolts.

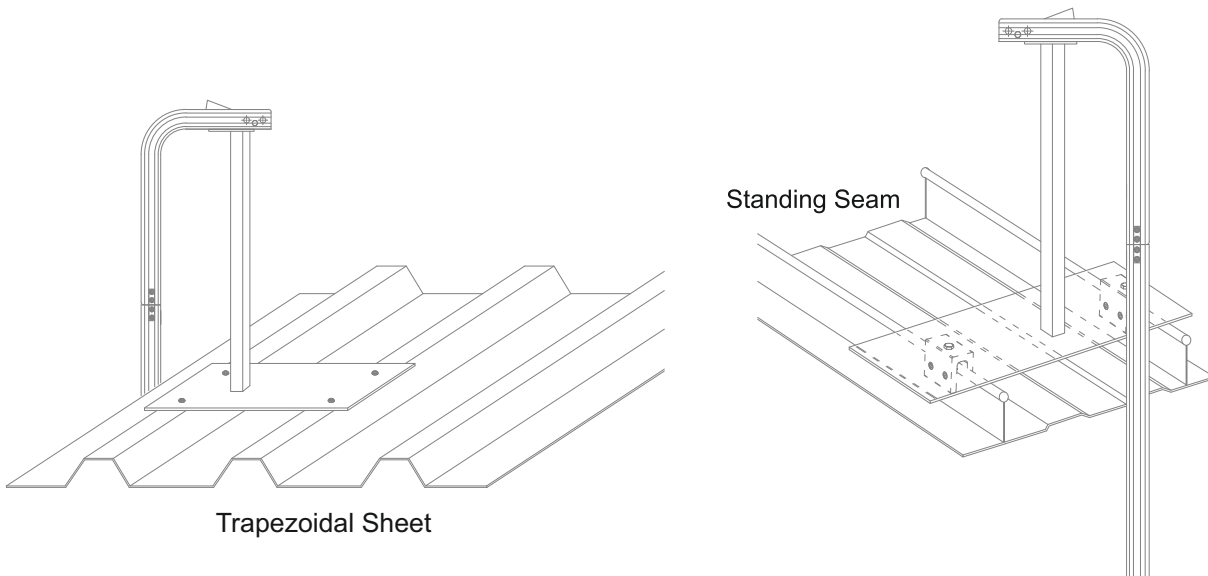

# VERTICAL ANCHORAGE RAIL LIFE LINE SYSTEM

## Step 4: Installation of the System on the Receiving Structure

### Installation of Mounting Nut

Insert the mounting nut into the aluminum rail extremity. The first mounting nut must be at 300mm from the bottom edge and second needs to be 1500mm from the first mounting nut and so on.

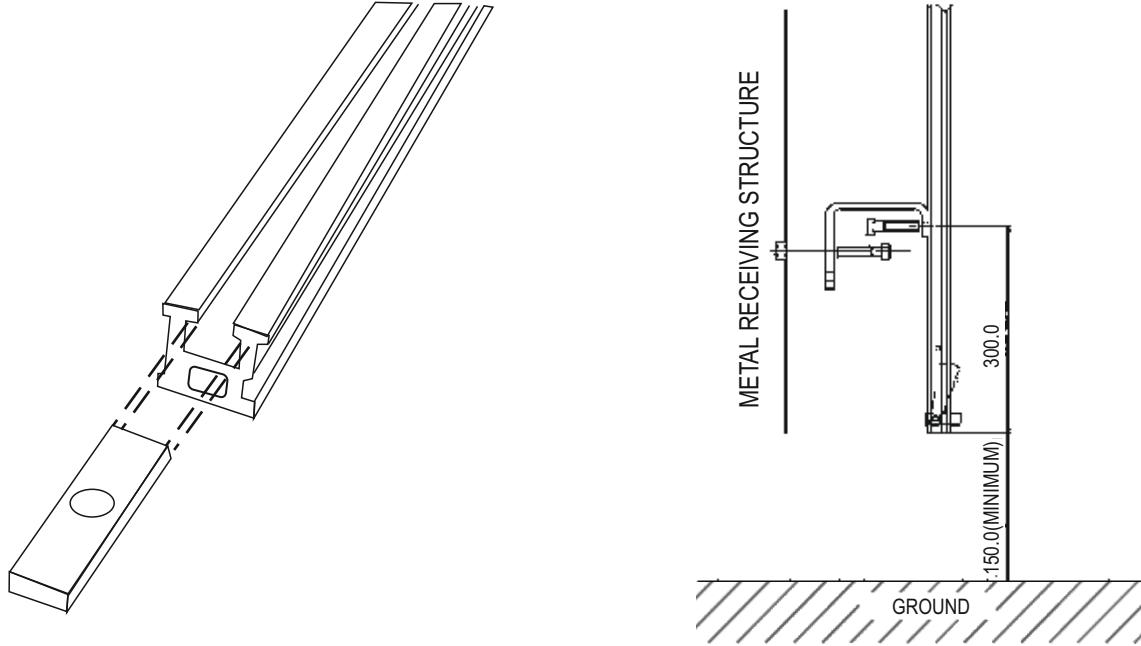

### Installation of Aluminum Extremity & Mounting Bracket

The Mounting Brackets can be installed on metal as well as concrete structure by special fasteners. Chemical fasteners are used to fix the brackets to the concrete wall and SS fasteners for metal structure. The shorter end of the bracket is mounted on aluminum rail by mounting nut and longer end to the receiving structure by using fasteners. For concrete installation, use M12 x 130mm chemical fastener (refer to Hilti HVU installation guide). Drill a 14mm diameter hole to a depth of 110mm. Refer below. If unsure, refer to an engineer.

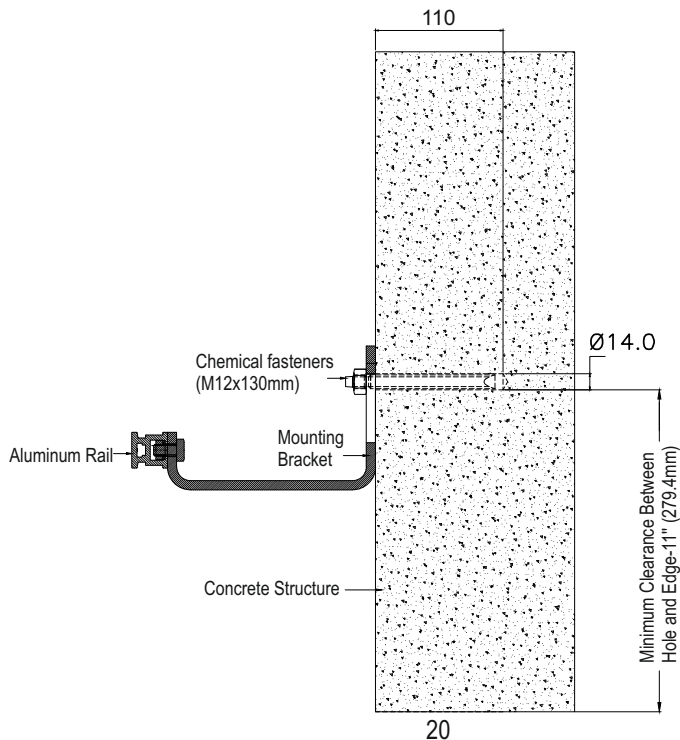

## Step 5: Installation of Ladder Rung

The aluminum rail has two holes at regular intervals to hold the rungs, insert the bolt along with washer into the rung and tighten it.

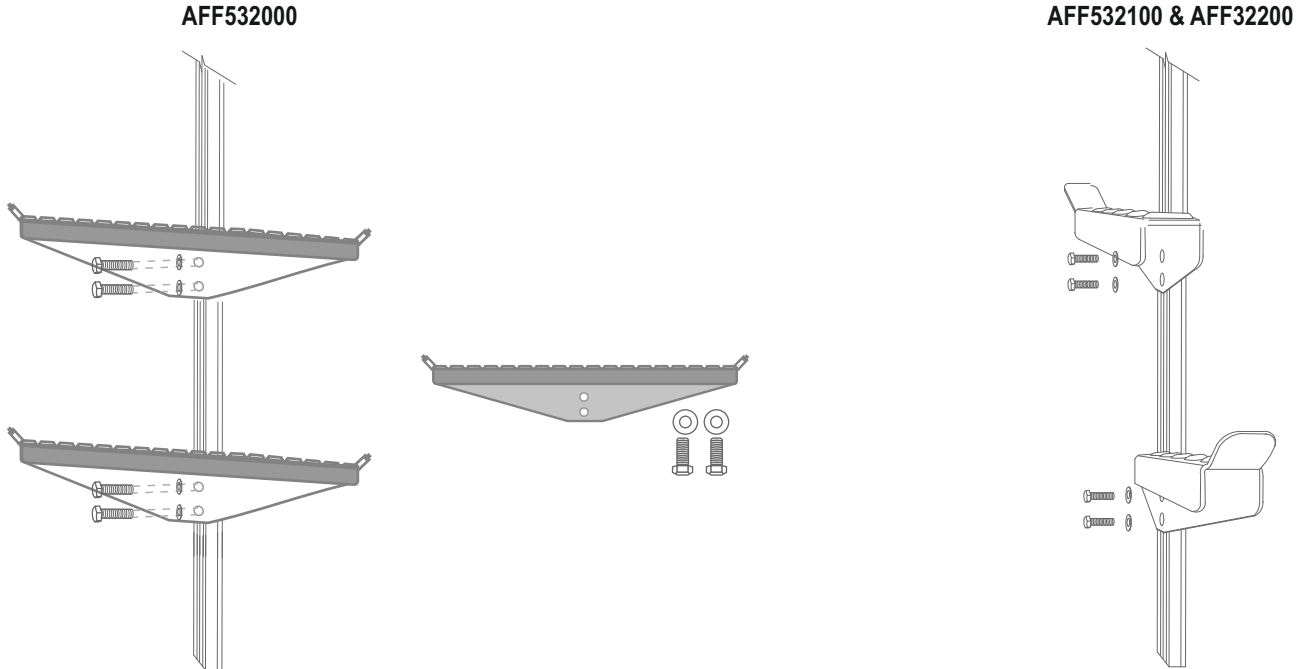

## Step 6: Vertical Trolley

- Insert the trolley in the aluminum rail extremity. Press the termination of the extremity and pass the trolley over the termination.
- After the trolley slides on the aluminum rail, the termination cones back to its original position ensuring that the trolley does not slide off the aluminum rail.

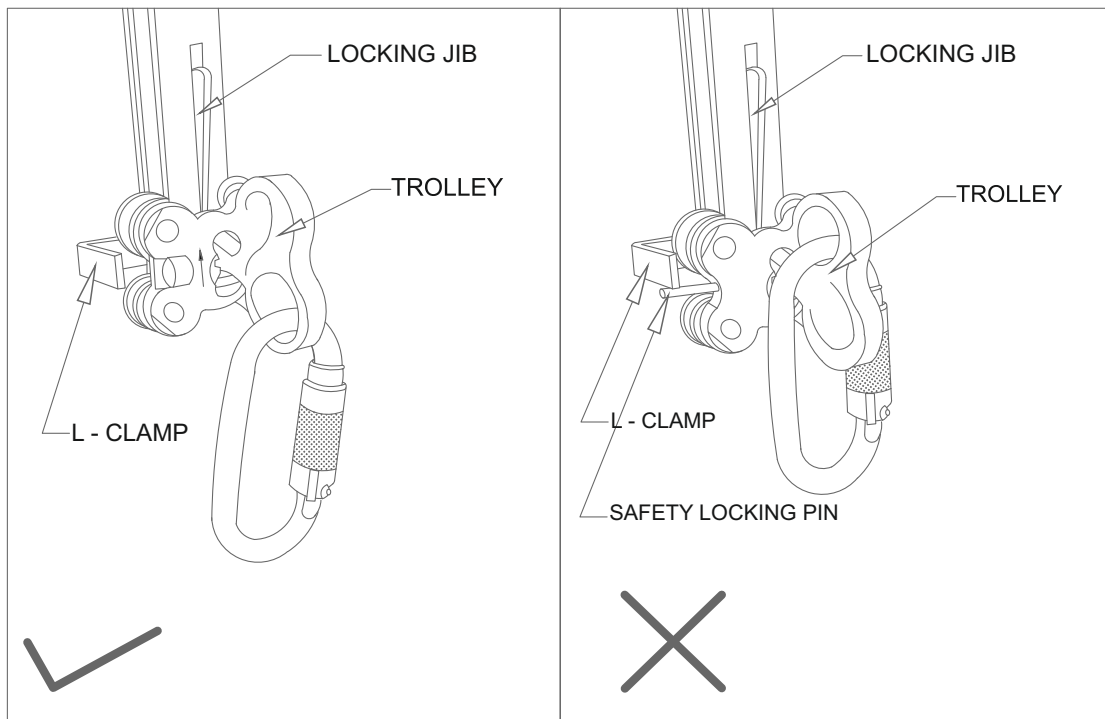



## Step 7: Installation of Adjustable Mounting Bracket

Install the aluminum rail on the side cladding of a pre-engineered building

Weld the adjustable bracket on the column of the building. If welding is not allowed, then drill holes and fasten the bracket to the column by fasteners.

Drill a hole in the wall sheet. Adjust the bracket so that it touches the trapezoidal sheet. Drill a hole in the sheet.

Fasten the mounting bracket to the adjustable bracket by fasteners.

Prefab concrete building structures use chemical fasteners to fix the brackets to the concrete wall using M12 chemical fastener (refer to Hilti HVU installation guide).

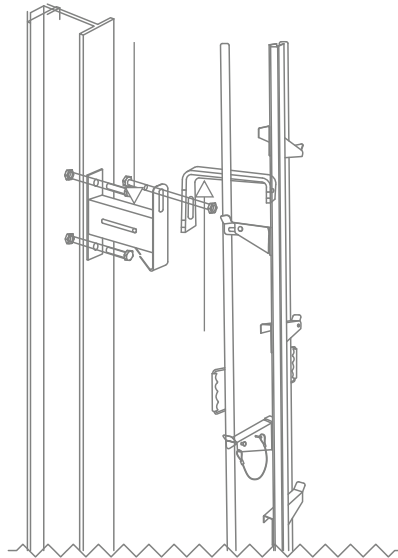

## Step 8: Installation of Folding Aluminum Rail Extremity

- Install the folding ladder on the structure using the mounting bracket and mounting nut.
- For locking, fold the rungs by pushing the handle up.
- To lock the ladder, hold the ladder in locked position by inserting the pin in the rung.
- Insert the lock in the hole of the latch and lock.
- Now only the user with a key can climb the ladder.

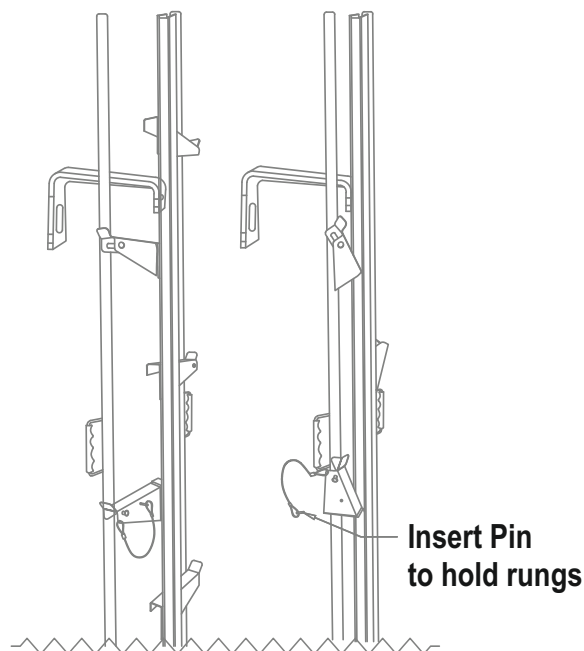

## Pre-Use Checks and Precautions

---

### Post Installation Inspection

---

- Once installed, it is important to inspect the complete line by moving the entire length of life line
- It is mandatory for the Site Inspector/Supervisor and the actual users of the system to perform a thorough check of the system before carrying out work. KStrong conducts a brief training for all concerned personnel on the subject of pre-use inspection of the system as per a defined guideline after the system has been installed by KStrong personnel. The following points are considered for the pre-use check:

### Checking the Receiving Structure

---

If the ladder or the receiving structure of ladder found weak, do not climb.

### Checking the System

---

- Clean the system from dust/dirt. Check for any mechanical defects.
- Check for wear and tear in all components or unusual bending or deformation.
- Check for any modifications done by the user.
- Check for any missing component.
- Check for any damages that may have been caused due to welding while maintenance of other equipment.
- Check the identification plate. The system needs to be put out of service if the label is not legible or missing.

### Check the Trolley & Connector

---

- Check the movement of the trolley & its grip.
- Check the movement of the trolley, it should move freely.
- Check for any mechanical defects.

## Precautions Need to be Considered for Safe Use of the System

---

The following points and precautions needs to be considered for safe use of the system:

- The life line is for the purpose of fall protection while working on a horizontal plane at height. A back up fall arrest system is required when transitioning on and off the life line system while working at height.
- The user should not suspend himself on the rope grab. The intended use of a rope grab is fall protection and not a work positioning device.
- Never disengage the fall arresting lanyard and the carriage body from the life line while working at height.
- Avoid using grease to lubricate the system. If any fall is reported, put the system out of use. Contact the manufacturer for repairs and re-validation.
- Only certified full body harness with proper attachment anchorage points should be worn while using the system.
- Do not alter or misuse this equipment. Always take the advice from KStrong personnel while using this equipment in combination with components or subsystems other than those described in this manual. Usage of certain component/sub system may interfere with the proper functioning of this equipment and the system may not deliver or work as per its intended use. In such case, KStrong may not be held responsible for any malfunction.
- The lifelines must be kept free from dust, grease etc., by periodic cleaning. The system can be cleaned by a soft dry cloth.

## Hazards

---

Hazards existing in immediate environment may require additional precautions to limit the possibility of injury to the user or damage to the equipment. Hazards may include but are not limited to, extreme temperatures, caustic chemicals, corrosive environments, high voltage power lines, explosive or toxic gases, moving machinery, sharp edges, high velocity winds etc.

Do not expose the equipment to any hazard which it is not designed to withstand. Consult the manufacturer if in doubt.

## Rescue Plan

---

It is recommended to ensure that the user shall have a rescue plan and means to execute it while using this equipment. The rescue plan needs to be project specific. The employees must be trained in self-rescue or alternative means shall be provided for prompt rescue in an event of a fall.

## Miscellaneous

---

It is recommended to work in a pair to ensure that in an event of a fall your partner may help in rescue.

## Annual Inspection & Revalidation

---

According to the requirement of EN365, every PPE needs to be inspected at least once in a year. The KStrong COMPASS software maintains the data of the system for at least 20 years and reminds the client whenever the inspection is due. The KStrong Inspection team is trained to perform the inspection and provide a certificate each year at a nominal cost. The client may at any given moment of time extract the status of any of the lifeline installed anywhere in the world from the KStrong data base.

## Environment

---

To protect the environment, KStrong follows a 100% paperless process. Unless specifically required, KStrong avoids printing it's reports and make it available to the client digitally.

## Inspection Use and Maintenance

### PPE Inspection and Revalidation

Fall Protection Equipment is a life saving product. As per the EN 365 of PPE Regulations 425/2016, it is mandatory to have a 'Competent Authority' to inspect the Fall Protection Equipment at least once annually.

KStrong COMPASS software helps taking care of the equipment.

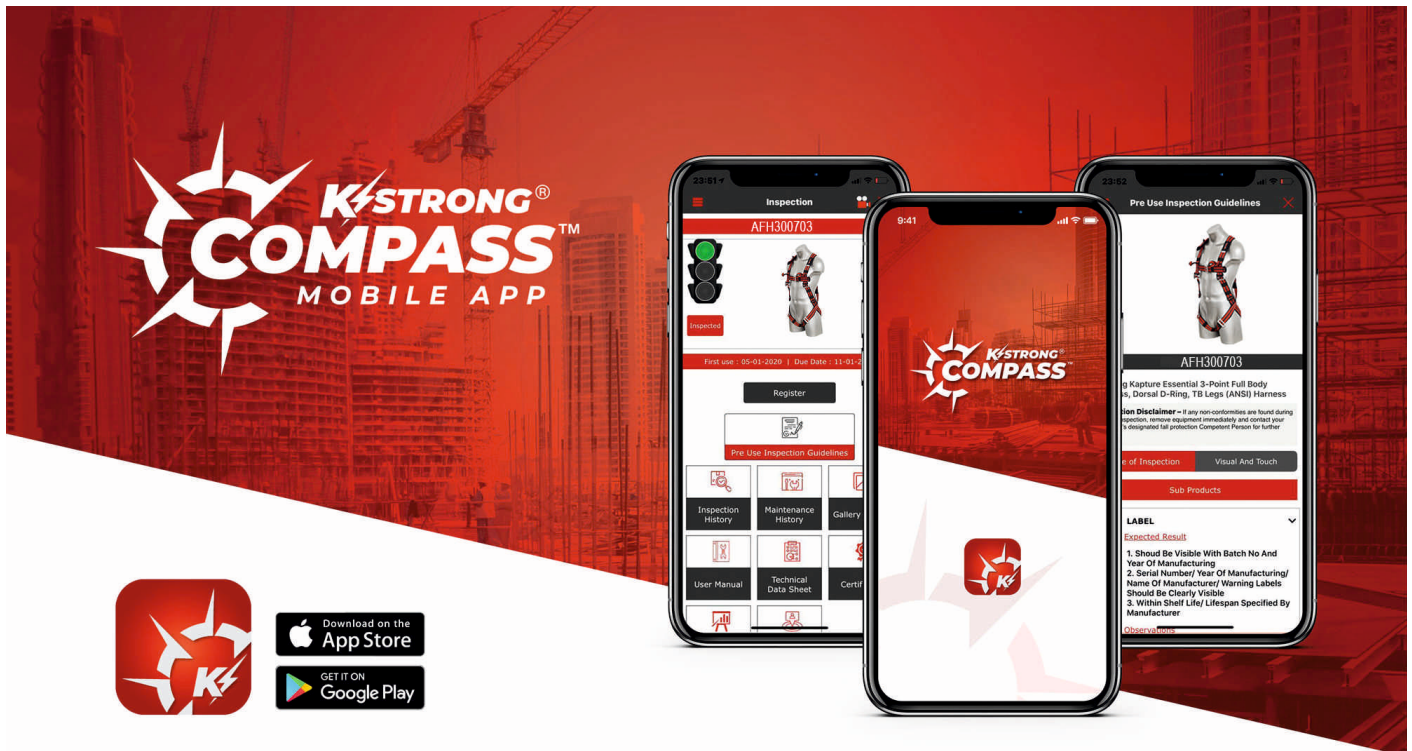

- Cloud based online as well as off line software.
- Captures Geo Coordinates where the system is installed.
- RFID / Bar code compliant.
- Generates report in real time.
- Reminds user of items due for inspection.
- Captures images of components.
- User customizable.
- Can be integrated to client software.
- Reports can be shared with multiple recipients in real time.

### Infrastructure:

- Good quality equipment complying with international standards.
- 100% backward oriented manufacturing unit.
- Qualified engineering crew.
- Sophisticated test equipment.
- Precise engineering software to understand the client requirement to provide a safe & optimum solution.
- Technical marketing team capable of understanding the client requirement & present the solution using engineering drawings (Auto CAD) & calculations.
- Force predictions on the system in an event of a fall and a testing facility to validate the force calculations.

## Warranty

---

The system is produced with extreme precision. Should there arise a manufacturing defect within a period of 1 year of supply, KStrong stands to repair the components or replace if necessary.

Warranty does not cover:

- Deficiency arising out of misuse of equipment
- Malfunction due to faulty installation/wrong usage of product
- This equipment is not user maintainable. The warranty stands void if an attempt is made to repair or open the equipment.

KStrong does not provide a product functioning warranty; the warranty stands for the workmanship of the products only.

- KStrong systems are made of stainless steel grade 316, ED Coated Steel or Aluminum and are highly resistant to corrosion.
- KStrong systems are thus further warrantied for 20 years (15 years for Marine Environment) they are inspected once annually according to the requirements of EN365.

## Disclaimer

---

The receiving structure on which the system is installed should withstand 15 kN .

If in doubt, kindly get load calculation done from a competent authority or a certified structural engineer. KStrong does not take responsibility for malfunction due to inadequacy in the receiving structure.

Please ensure that the entire system is compatible with the other personal fall protection equipment used, and is in conformance with those recommended for use by KStrong. KStrong is not responsible for any changes which may be done in the system without a prior confirmation by KStrong authorized personnel.

Third Party Installations by uncertified installers are not recommended for these products. In case of third party installations, KStrong will not be held responsible for any failure of the product in its intended use.

# VERTICAL ANCHORAGE RAIL LIFE LINE SYSTEM

## Tools Required



RING SPANNER



DOUBLE END SPANNER



SOCKET SET



TENSIONER TIGHTENING TOOL



CRIMPING PLIER



BOLT CUTTER



ALLEN KEY

## Machines



CORDLESS DRILL MACHINE



HAMMER DRILL MACHINE



CORDLESS IMPACT WRINCH



HYDRA JAWS  
LIFELINE TESTING



SWAGING TOOL



HYDRAULIC CRIMPING HEAD







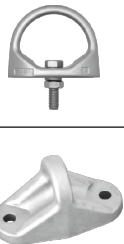

POWER BIRD RIVETING MACHINE

## Anchors



# VERTICAL ANCHORAGE RAIL LIFE LINE SYSTEM

## Measuring Tools

					
TAPE	DETECTOR	DIGITAL TORQUE WRENCH	DISTANCE METER	LASER TOOL	VERNIER

## Consumables, Miscellaneous Tools

						
DUST PUMP	HOLE SAW CUTTER	HOT AIR GUN	SETTING TOOL	PAINT BRUSH	DRILL BIT	IMPACT DRILL
						
BLOWER	CHEMICAL APPLICATOR					

WRENCH SIZE					
Hex Bolt	6	8	10	12	16
Wrench Size	10	13	16	19	24
Socket Size	10	13	16	19	24

ALLEN KEY SIZE				
Allen Bolt Size	6	8	10	12
Allen Key Size	4	6	8	10
Allen Grub Screw Key Size	3	4	5	6

## Torque Chart (Maximum torque for standard bolts)

CHART						
Bolt size	6 mm	8 mm	10 mm	12 mm	14 mm	16 mm
Recommended Torque:	18 Nm	55 Nm	88 Nm	118 Nm	155 Nm	200 Nm







**Inspection Log**

<b>EQUIPMENT RECORD</b>				
Product				
Model & type/Identification		Trade Name		Identification number
Manufacturer		Address		Tel, Email
Year of manufacture		Purchase Date		Date first put into use
Other relevant information (eg. document number)				
<b>PERIODIC EXAMINATION AND REPAIR HISTORY</b>				
Date	Reason for entry (periodic examination or repair)	Defects noted, repairs carried out and other relevant information	Name and signature of competent person	Periodic examination next due date





KStrong Asia Pte Ltd  
33A Chander Road,  
Singapore 219539  
Email: [customercare@kstrong.com](mailto:customercare@kstrong.com)

[www.kstrong.com](http://www.kstrong.com)

---

USA

South America

Asia

---