

MEMBRANE ROOF TOP CORNER POST (90 DEGREE)

AFA935292(90)

Features

- The 90 degree corner is designed to be fixed on a variety of membrane covered roof structures such metal, wood ply or concrete allowing a change of direction of the horizontal lifeline.
- To be installed on membrane roofs with the help of 4 x M8 x 300mm toggle anchors drilled through the insulation metal, wood ply or concrete.
- Supplied with 4 x Membrane washers to cover the top of the toggle bolts allowing for a flat surface when covering with the water proof membrane.
- Can be installed at the time of the initial roof construction, or retro-fitted to existing structures.
- Can be installed anywhere on a flat roof environment.

How To Use

Refer to User Instruction Manual



Metal Components

Base Plate	:	316 Stainless Steel : Electro Polished
Corner	:	316 Stainless Steel: Electro-Polished
Toggle Bolts and Hex Bolt	:	M8 x 300mm 316 Stainless Steel
Membrane Washer	:	TPU
Minimum Breaking Strength	:	15 kN

Weight

3.879 kg ± 0.020 kgs

Relevant Standards

Conforms to EN 795:2012 TYPE C, AS/NZS 5532:2013 & TS16415:2013 TYPE C



Membrane Washers

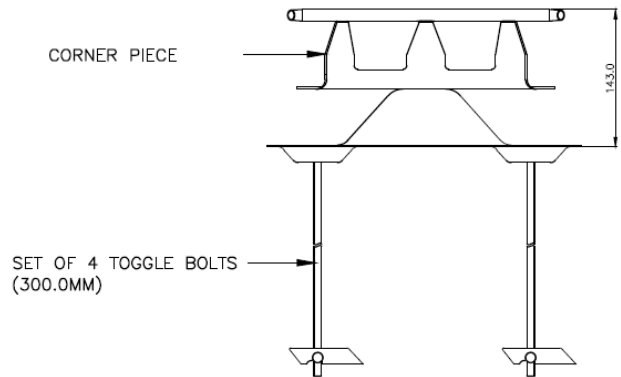
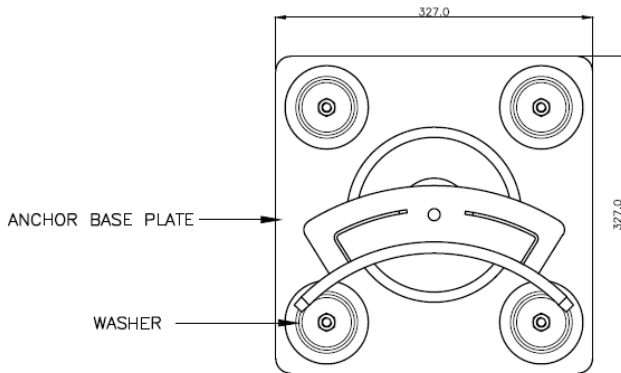

CE 0598